

ALVIUM MIPI CSI-2 CAMERAS

Adapter Board for AMD Xilinx Kria KV260 Vision AI Starter Kit

User Guide

V1.0.2

**Quick links**

- [This document at a glance](#) on page 15
- [Contact us](#) on page 17
- [Contents](#) on page 18

Read before use

EN - English

Safety

Before using the product, read these safety instructions. Observe the warnings at all times. Use the product only as stated in the [Intended use](#) on page 24.

**CAUTION****Risk of burns**

The product in operation can reach temperature levels which could cause burns.

**CAUTION****Risk of cuts by sharp edges**

The product can have sharp edges.

Intended use

Intended use of Allied Vision product is the integration into vision systems by professionals. All Allied Vision product is sold in a B2B setting.

DA - Dansk

Sikkerhed

Læs sikkerhedsanvisningerne, før produkt bruges. Overhold alle advarsler. Brug kun produkt som anført i [Intended use](#) på side 24.



FORSIGTIG

Forbrændingsfare

Når produkt bruges, kan det blive meget varmt og forårsage forbrændinger.



FORSIGTIG

Fare for skarpe kanter

Produktet kan have skarpe kanter.

Tilsigtet brug

Allied Vision produktets tilsigtede brug er en indbygning i et visionssystem, udført af fagfolk. Alle Allied Vision produkter sælges i B2B.

DE - Deutsch

Sicherheit

Bevor Sie das Produkt benutzen, lesen Sie diese Sicherheitshinweise. Beachten Sie diese Hinweise immer. Verwenden Sie das Produkt nur wie beschrieben in [Intended use](#) auf Seite 24.



VORSICHT

Gefahr von Verbrennungen

Im Betrieb kann das Produkt Temperaturen erreichen, die zu Verbrennungen führen.



VORSICHT

Schnitte durch scharfe Kanten

Das Produkt kann scharfe Kanten haben.

Bestimmungsgemäßer Gebrauch

Allied Vision Produkte sind bestimmt für die Integration in Bildverarbeitungssysteme durch Fachpersonal. Alle Allied Vision Produkte werden in einer B2B-Umgebung verkauft.

ES - Español

Seguridad

Antes de utilizar el producto lea estas instrucciones de seguridad. Observe las advertencias en todo momento. Utilice el producto solo tal y como se estipula en el [Intended use](#) en la página 24.



ATENCIÓN

Riesgo de quemaduras

El producto en funcionamiento puede alcanzar temperaturas que podrían provocar quemaduras.



ATENCIÓN

Riesgo de cortes por bordes afilados

El producto puede tener bordes afilados.

Uso previsto

El uso previsto del producto Allied Vision es la integración en el sistema de visión por parte de profesionales. Todos los productos Allied Vision se venden dentro de una relación B2B.

FI - Suomi

Turvallisuus

Lue nämä turvallisuusohjeet ennen tuotteen käyttöä. Noudata tuotetta joka hetki. Käytä tuotteen ainoastaan kohdassa [Intended use](#) sivulla 24 kuvatulla tavalla.



HUOMIO

Palovammojen vaara

Käytössä olevan tuotteen saavuttamat lämpötilatasot voivat aiheuttaa palovammoja.



HUOMIO

Terävien reunojen aiheuttama viiltovaara

Tuotteessa voi olla teräviä reunoja.

Käyttötarkoitus

Allied Vision-tuotteen käyttötarkoitus on integrointi kuvajärjestelmiin ammattilaisten toimesta. Kaikki Allied Vision-tuotteet myydään B2B-ympäristössä.

FR - Français

Sécurité

Veuillez lire ces consignes de sécurité avant d'utiliser le produit. Respectez continuellement les avertissements. Utilisez le produit uniquement comme indiqué sous [Intended use](#), page 24.



ATTENTION

Risque de brûlures

Le produit en service peut atteindre des niveaux de température susceptibles d'entraîner des brûlures.



ATTENTION

Risque de coupures sur des bords tranchants

Le produit peut présenter des bords tranchants.

Utilisation prévue

L'utilisation prévue du produit Allied Vision est son intégration dans des systèmes de vision par le soin de professionnels. Tout produit Allied Vision est vendu dans un cadre B2B.

עברית - HE

בטיחות

לפני השימוש במוצר, עליך לקרוא את הוראות הביטחון האלו. עליך לממש הוראות ביטחון אלו תמיד. השימוש במצלמה הוא רק לפי מה שכתוב ב"כוונת השימוש" (Intended use בעמוד 24).

זהירות

סכנת כווייה

בזמן הפעלת המוצר עלולות לעלות טמפרטורות גבוהות, שיכולות לגרום לכוויות.



זהירות

סכנת חתכים על ידי קצוות חדים

למוצר יכולים להיות קצוות חדים.



שימוש מיועד

מוצרי AlliedVision מיועדים לשילוב במערכות ממוחשבת לעיבוד צילומים ע"י אנשי מקצוע. כל מוצרי AlliedVision נמכרים לשימוש בסביבת B2B.

IT - Italiano

Sicurezza

Leggere queste istruzioni per la sicurezza prima di utilizzare il prodotto. Osservare sempre tutte le avvertenze. Utilizzare il prodotto come descritto alla sezione [Intended use](#) a pagina 24.



ATTENZIONE

Pericolo di ustioni

Durante il funzionamento, il prodotto può raggiungere temperature elevate che possono essere causa di ustioni.



ATTENZIONE

Pericolo di tagliarsi sui bordi affilati

I bordi del prodotto lente possono essere affilati.

Uso previsto

Il prodotto Allied Vision è concepito per essere integrato in sistemi di monitoraggio in campo professionale. Tutti i prodotti Allied Vision sono venduti in uno scenario B2B.

JA – 日本語

安全性

本製品を使用する前に、この安全ガイドをお読みください。警告を必ず守ってください。必ず21ページのIntended use 24 ページに従って使用してください。



注意

やけどの危険性

作動中のカメラは、やけどを引き起こす温度まで熱くなる恐れがあります。



注意

な端部で切り傷の危険性

本製品には鋭利な部分がある場合があります。

用途

Allied Vision製品は、専門家が視覚装置に統合することを意図したものです。すべてのAllied Vision製品は、企業間取り引き用に販売されています。

NL - Nederlands

Veiligheid

Lees deze veiligheidsinstructies voordat u het product gebruikt. Neem deze waarschuwingen altijd in acht. Gebruik het product uitsluitend, zoals aangegeven in het [Intended use](#) op pagina 24.



VOORZICHTIG

Risico van verbranding

Het gebruikte product, kan temperatuurwaarden bereiken die brandwonden kunnen veroorzaken.



VOORZICHTIG

Risico van snijwonden door scherpe randen

Het product kan scherpe randen hebben.

Beoogd gebruik

Het beoogde gebruik van het Allied Vision-product is de integratie in optische systemen door professionals. Alle Allied Vision-producten worden verkocht in de B2B-markt.

NO - Norsk

Sikkerhet

Les disse sikkerhetsinstruksene før du bruker produkt. Følg advarslene til en hver tid. Bruk kun produkt i samsvar med [Intended use](#) på side 24.



FORSIKTIG

Risiko for brannskader

Produktet i bruk kan nå temperaturnivåer som kan forårsake brannskader.



FORSIKTIG

Risiko for kutt fra skarpe kanter

Produktet kan ha skarpe kanter.

Tiltenkt bruk

Den tiltenkte bruken av Allied Vision-produktet er integrering i visjonssystemer av profesjonelle. Alle Allied Vision-produkter selges i en forretning til forretning-situasjon.

SV - Svenska

Säkerhet

Läs igenom säkerhetsinstruktionerna innan du använder produkten. Var hela tiden särskilt uppmärksam på varningarna. Använd enbart produkten på det sätt som anges i [Intended use](#) på sida 24.



VARNING

Risk för brännskada

Produkten i drift kan komma upp i temperaturer som kan orsaka brännskador.



VARNING

Risk för skärsår från vassa kanter

Produkten kan ha vassa kanter.

Avsedd användning

Den avsedda användningen av Allied Vision-produkter är integrering i visionsystem av fackmän. Samtliga Allied Vision-produkter säljs i en B2B-miljö.

ZH – 简体中文版

安全需知

在使用产品之前，请阅读这些安全说明。请务必遵守相关警告 和 [Intended use](#) 于第 24 页。



注意事项

烫伤风险

在产品运行过程中，温度可能会上升，导致烧伤的危险。



注意事项

锋利边缘割伤的风险

产品可能有锋利的边缘。

预期用途

Allied Vision 产品的预期用途是由专业人士整合到视觉系统中。所有 Allied Vision 的产品均通过 B2B 渠道销售。

This document at a glance



This chapter includes:

Shipping contents.....	16
What else do you need?	16

**Read this document carefully**

Learn to use adapter boards in the most safe and efficient way and avoid damage to your embedded system.

Shipping contents

The delivery consists of the Adapter Board CSI-2 AMD Xilinx Kria KV260 with no other components.

**FPC cables and cable ties are not included**

The following contents are not included:

- Flexible printed circuit (FPC) cable to connect adapter boards to cameras
- Cable tie for strain relief with FPC cables.

What else do you need?

**Technical information and ordering of Allied Vision products**

- For all information about Alvium CSI-2 cameras and accessories, see www.alliedvision.com/en/support/technical-documentation/alvium-csi-2-documentation.
- Please contact your Allied Vision Sales representative for ordering and for additional information on hardware options for Alvium cameras.

**Technical information on Xilinx Kria embedded boards**

For information on Xilinx Kria embedded boards see www.xilinx.com/products/som

Contact us

Website, email

General

www.alliedvision.com/en/contact
info@alliedvision.com

Distribution partners

www.alliedvision.com/en/avt-locations/avt-distributors

Support

www.alliedvision.com/en/support
www.alliedvision.com/en/about-us/contact-us/technical-support-repair-/-rma

Offices

Europe, Middle East, and Africa (Headquarters)

Allied Vision Technologies GmbH
Taschenweg 2a
07646 Stadtroda, Germany
T// +49 36428 677-0 (Reception)
T// +49 36428 677-230 (Sales)
F// +49 36428 677-28

Asia-Pacific

China

Allied Vision Technologies
(Shanghai) Co., Ltd.
2-2109 Hongwell Int. Plaza
1602# ZhongShanXi Road
Shanghai 200235, China
T// +86 21 64861133

Singapore

Allied Vision Technologies Asia Pte. Ltd
82 Playfair Rd, #07-01 D'Lithium
Singapore 368001
T// +65 6634 9027

North, Central, and South America

Canada

Allied Vision Technologies Canada Inc.
300 – 4621 Canada Way
Burnaby, BC V5G 4X8, Canada
T// +1 604 875 8855

USA

Allied Vision Technologies, Inc.
102 Pickering Way- Suite 502
Exton, PA 19341, USA
Toll-free// +1-877-USA-1394
T// +1 978 225 2030

Contents

Read before use	2
This document at a glance	15
Shipping contents	16
What else do you need?	16
Contact us	17
Document history and conventions	20
Document history	21
Conventions used in this user guide	21
Typographical styles	21
Symbols and notes	21
Component naming	22
Compliance, safety, and intended use	23
Compliance notifications	24
Intended use	24
Copyright and trademarks	24
Your safety	25
Handling hot adapter boards	25
Sharp edges	25
Product safety	25
Embedded systems	25
Electrical connections	25
Electrostatic discharge (ESD)	26
Camera power	26
FPC connectors	26
MIPI CSI-2 FPC cables	27
Specifications	29
General specifications	30
PCB and PCBA number	30
Dimensions and PCB layout	31
Electronic schematics	32
Camera power	33
I/O connections	33
Using the adapter board	34
Embedded system accessories	35
Connecting FPC cables to Hirose FPC connectors	35

Installing adapter boards	37
Connecting the embedded board	38
Connecting the camera	39
Connecting USB power	40
Connecting the I/Os	41
I/O signal levels and description	42

Document history and conventions



This chapter includes:

Document history	21
Conventions used in this user guide.....	21
Component naming	22

Document history

Version	Date	Remarks
V1.0.2	2024-Feb-23	Added UKCA symbol in Compliance notifications on page 24.
V1.0.1	2023-Sep-06	Updated the product naming of the adapter board for consistency.
V1.0.0	2023-Aug-24	Release version

Table 1: Document history

Conventions used in this user guide

To give this user guide an easily understood layout and to emphasize important information, the following typographical styles and symbols are used:

Typographical styles

Style	Function
Emphasis	Highlighting important things
Web links and references	Links to webpages and internal cross references

Table 2: Typographical styles

Symbols and notes



CAUTION

Risk of burns

Precautions are described.



CAUTION

Risk of cuts by sharp edges

Precautions are described.



NOTICE

Material damage

Precautions are described.

Practical tip

Additional information helps to understand or ease handling the camera and components.

Additional information

Web link or reference to an external source with more information is shown.

Component naming

Components described in this user guide are not defined by common standards. Therefore, naming must be accurate to avoid misconceptions. Because naming is lengthy, reading is difficult. Simplified terms are used in this document.

Long version	Short version used in this document
Adapter Board CSI-2 AMD Xilinx Kria KV260	Adapter for Xilinx Kria KV260
MIPI CSI-2 ¹ adapter board	Adapter board
MIPI CSI-2 FPC (flexible printed circuit) cable	FPC cable

¹MIPI CSI-2 Mobile Industry Processor Interface Camera Serial Interface 2

Table 3: MIPI CSI-2 adapter board naming

Compliance, safety, and intended use



This chapter includes:

Compliance notifications	24
Intended use	24
Copyright and trademarks	24
Your safety.....	25
Product safety	25

Compliance notifications



National regulations on disposal must be followed.

Intended use

Allied Vision's objective is the development, design, production, maintenance, servicing and distribution of digital cameras and components for image processing. We are offering standard products as well as customized solutions.

Intended use of Allied Vision product is the integration into Vision systems by professionals. All Allied Vision product is sold in a B2B setting.

Allied Vision isn't a legal manufacturer of medical product. Instead, Allied Vision cameras and accessories may be used as components for medical product after design-in by the medical device manufacturer and based on a quality assurance agreement (QAA) between Allied Vision (supplier) and medical device manufacturer (customer). Allied Vision's duties in that respect are defined by ISO 13485, clause 7.2 (customer-related processes, equivalent to ISO 9001, clause 8.2).

Copyright and trademarks

All text, pictures, and graphics are protected by copyright and other laws protecting intellectual property. All content is subject to change without notice.

All trademarks, logos, and brands cited in this document are property and/or copyright material of their respective owners. Use of these trademarks, logos, and brands does not imply endorsement.

Copyright © 2024 Allied Vision Technologies GmbH. All rights reserved.

Your safety

This section informs about issues related to your personal safety. Descriptions explain how to avoid hazards and use adapter boards safely.

Handling hot adapter boards

Electrical components of adapter boards get hot during operation.

Before operation, include adapter boards in housings that disable any contact to hot components.

Sharp edges

The edges of PCBs (printed circuit boards) and the assembled components can be sharp. Be careful these edges do not cut your skin when handling adapter boards.

Product safety

To prevent material damage, read the following to understand risks in using adapter boards.

Embedded systems

Setup and operation of Alvim CSI-2 cameras in embedded systems is different than for cameras in PC-based systems. Components can easily be damaged. If you are unfamiliar with embedded systems, be extremely careful. Follow the instructions in the Alvim CSI-2 Cameras User Guide.

Electrical connections

The MIPI CSI-2 standard does not specify electrical connections as extensively as the USB or GigE standard. Read specifications carefully.

Alvim CSI-2 cameras are not protected against damage caused by reverse polarity.

Electrostatic discharge (ESD)

Electrostatic discharge (ESD) is dangerous for electronic devices, especially when tools or hands get in contact with connectors. We recommend measures to avoid damage by ESD:

- **Unpacking:** Remove the adapter board from its anti-static packaging only when your body is grounded.
- **Workplace:** Use a static-safe workplace with static-dissipative mat and air ionization.
- **Wrist strap:** Wear a static-dissipative wrist strap to ground your body.
- **Clothing:** Wear ESD-protective clothing. Keep components away from your body and clothing. Even if you are wearing a wrist strap, your body is grounded but your clothes are not.
- **Housing:** use an ESD protective housing, including the camera, embedded board, adapter board, and FPC cable.

Camera power

Operating cameras beyond the specified range damages cameras. Cameras are powered using the FPC connector at a maximum input of 5.5 VDC, using a limited power source (LPS), according to IEC62368-1: 2014 (Second Edition) with minimum 1.5 A per camera. Cameras are not intended to be connected to DC distribution networks.

We recommend you to power the camera with a USB 2.0 Micro B power supply providing 1.5 A. Depending on the camera model and the intensity of use of the camera by your application, the power consumption may be lower.

FPC connectors

Hirose FH55-22S-0.5SH FPC connectors enable compact camera design. The small-sized connectors are sensitive to mechanical stress and are specified for maximum 20 mating and unmating cycles. Especially if you are inexperienced with this connector, be very cautious. If the FPC connector is broken, the complete device must be replaced. Follow the instructions in [Using the adapter board](#) on page 34 carefully.

- Avoid stress to FPC connectors.
- Allow only the FPC cable to touch conductors.

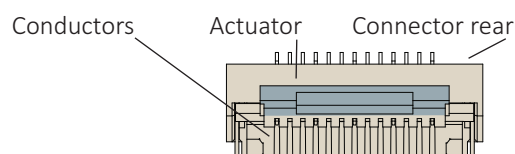

Figure 1: Hirose FH55-22S-0.5SH FPC connector



Additional information

For technical data and more instructions on the Hirose FH55-22S-0.5SH connector, see the manufacturer data sheet at www.hirose.com.

Handling the actuator

- Move the actuator only between 0° (locked position) to 105° (open position).
- Carefully flip the actuator at the middle with your finger nail, see [Connecting FPC cables to Hirose FPC connectors](#) on page 35.

MIPI CSI-2 FPC cables



Manufacturing FPC cables or embedded boards

If you want to design your own components to connect Alvium CSI-2 cameras to embedded boards, contact your Allied Vision Sales representative or visit www.alliedvision.com/en/about-us/contact-us/technical-support-repair/-rma.

FPC cable position

Short circuits of the FPC cable can damage the camera or connected hardware.

- Insert the FPC cable into the connector with cable guiding tabs matching the connector's side guides. See [Connecting FPC cables to Hirose FPC connectors](#) on page 35.
- Connect the camera and the embedded board (adapter) only as shown by the arrow printed on the FPC cable, see [Connecting FPC cables to Hirose FPC connectors](#) on page 35.

FPC cables and stress

Over-stressed FPC cables can damage the camera and connected hardware. When camera and embedded board are twisted against each other or pulled apart from each other with too much force, the FPC cable is over-stressed. Spring contacts of FPC connectors are worn out, causing short circuits and unreliable electrical connections.

- Insert the FPC cable into the FPC connector at 12° to the PCB board surface. See [Connecting FPC cables to Hirose FPC connectors](#) on page 35.
- Allow only slight bending of the FPC cable (minimum bending radius: 10 mm).
- For strain relief, we recommend you to mount the embedded board, adapter board, and camera to a common base.

No hot-plugging for MIPI CSI-2

Alvium CSI-2 cameras do not support hot-plugging. Hot-plugging can destroy the camera and connected hardware by high inrush current.

- Disconnect power supplies before connecting FPC cables.

FPC cable signal quality

Noise and electromagnetic interference can disable camera functions.

- Avoid contact to metal surfaces, causing electromagnetic interference.
- Please use cables recommended by Allied Vision.

Specifications



This chapter includes:

General specifications	30
Dimensions and PCB layout	31
Electronic schematics	32
Camera power	33
I/O connections.....	33

Dimensions and PCB layout

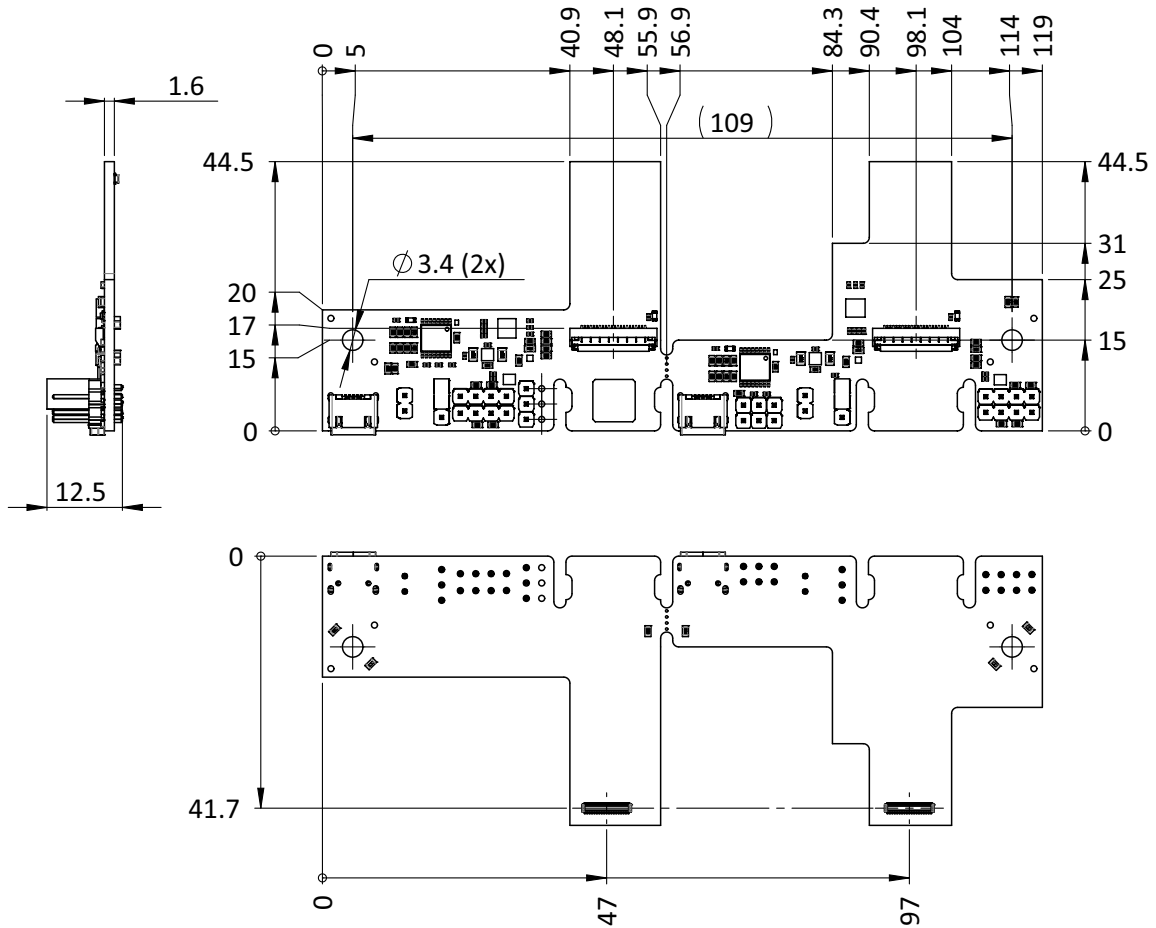
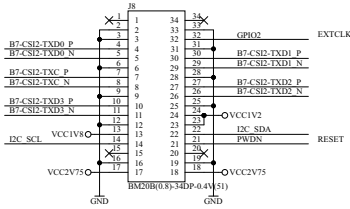

Figure 3: Adapter for Xilinx Kria KV260 dimensions and PCB layout

Electronic schematics

To Xilinx Kria KV260

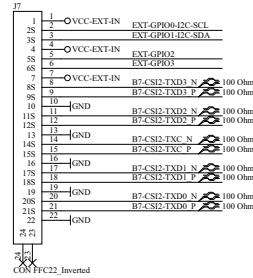

To Alivium cameras

Note: J9 is not equipped

Note: R17 and R18 are not equipped

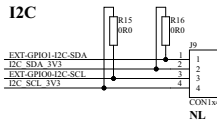
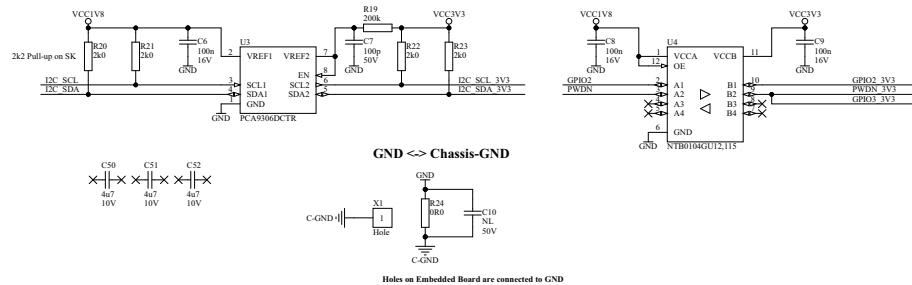
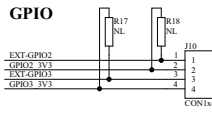
I2C

GPIO

GND <-> Chassis-GND

Holes on Embedded Board are connected to GND



VCC-EXT-IN : DCIN 4V5...5V5, max. 1.5 A per Camera
external USB Power

external Power

Figure 4: Adapter for Xilinx Kria KV260 electronic schematics

Camera power

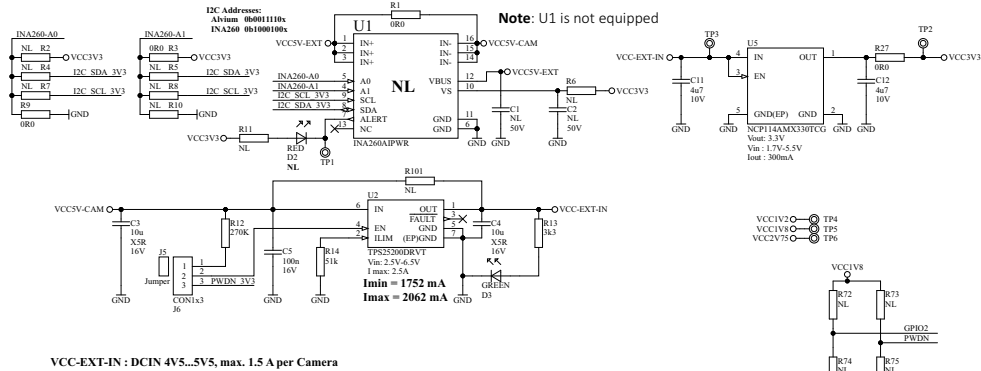
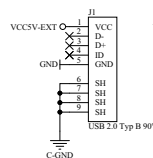
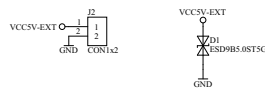

NOTICE

Damage to power supplies

If power supplies do not provide sufficient current, they may be damaged.

Ensure USB power supplies provide 1.5 A. Depending on the camera model and the intensity of use of the camera by your application, the power consumption may be lower.

Power Alvium cameras using the USB 2.0 Micro B receptacle (J1). See the description in [Electronic schematics](#) on page 32.

I/O connections

You can use the I/O lines to trigger the camera or to output a signal from the camera to trigger a device, such as a strobe light to control illumination. Camera I/Os can be connected to the embedded board I/Os through the adapter board's pin headers. See [Table 5](#) on page 42 for details.

If you want to reduce signal latencies, such as for triggering the camera by a light barrier, you can connect I/O cables directly to the adapter board. Please see the instructions in [Connecting the I/Os](#) on page 41.

Using the adapter board



This chapter includes:

Embedded system accessories	35
Connecting FPC cables to Hirose FPC connectors	35
Installing adapter boards	37

Embedded system accessories



FPC cables

For more information, see the Alvium Cameras Accessory Guide at www.alliedvision.com/en/support/technical-documentation/alvium-csi-2-documentation.



Designing your own embedded components

If you want to design your own components to connect Alvium CSI-2 cameras to embedded boards, contact your Allied Vision Sales representative or visit www.alliedvision.com/en/about-us/contact-us/technical-support-repair-/rma.

Proper usage of the Hirose FH55-22S-0.5SH FPC connector is vital for connecting Alvium CSI-2 cameras to embedded boards. Therefore, instructions start with usage of the FPC connector. Afterwards, setting up the adapter boards is described.

Connecting FPC cables to Hirose FPC connectors

Figure 5 shows how the FPC cable connects to the FPC connector.

Follow the instructions to connect the FPC cable to the camera and to the embedded board.

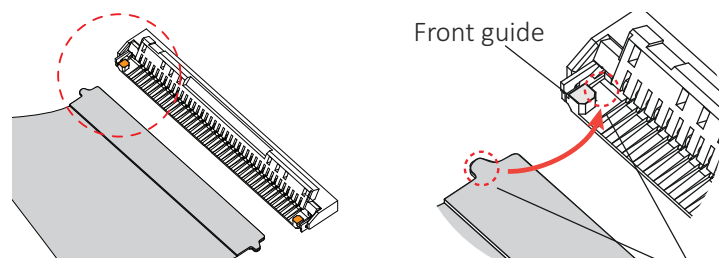

Figure 5: FPC cable and FPC connector (open position)

1. Opening the FPC connector:
With your fingernail*, flip the actuator to open position at 105° to the PCB surface, see Figure 6.

*Or use a plastic tool, as metal tools can damage the actuator.

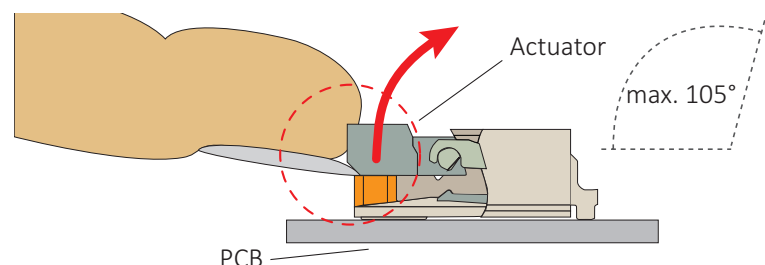

Figure 6: Opening the FPC connector

NOTICE
Damage to the camera by reverse polarity

If Alvium CSI-2 cameras are powered with reverse polarity, camera electronics is damaged.

- Before connecting camera power and I/O power, carefully read the Alvium Cameras User Guide for the FPC connector pin assignment.
- Connect the cable as shown in this section.

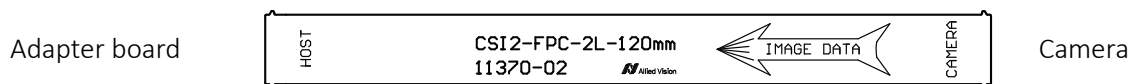

Figure 7: FPC cable image data direction

2. **Ensuring proper cable direction between host and camera**, take the FPC cable with conductors facing the FPC connector conductors (see Figure 8).

3. Inserting the FPC cable:
At a horizontal angle of 90° to the connector's rear (see Figure 8) and at a vertical angle of 12° to the PCB (see Figure 9), slowly insert the FPC cable into the actuator...

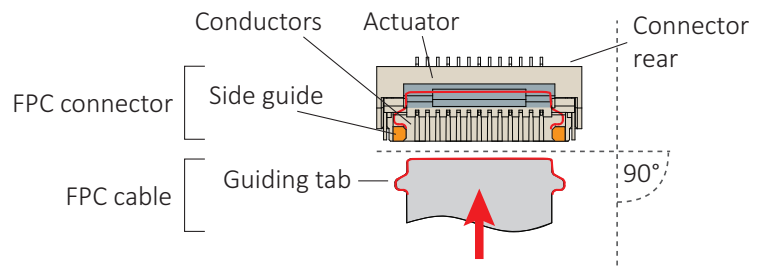

Figure 8: FPC cable and FPC connector

4. ...until cable guiding tabs are caught between connector rear and side guides (see Figure 8). Pull the cable slightly to ensure guiding tabs are properly engaged.
5. Holding the FPC cable in position, flap down the actuator to closed position (see Figure 9).

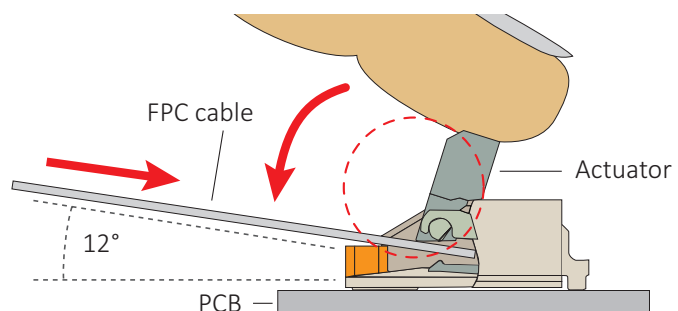

Figure 9: Engaging the FPC cable in the FPC connector

Installing adapter boards



CAUTION

Burns to the skin

Electrical components get hot during operation.

- Before operation, include adapter boards in housings that disable any contact to hot components.



CAUTION

Risk of cuts by sharp edges

The edges of PCBs and the assembled components can be sharp.

- Wear protective gloves when you touch adapter boards.



NOTICE

Damage to electronics

- Disconnect all power supplies before installing the adapter board to your embedded board.
- Reconnect power only after installation is complete.
- Mount the embedded board, adapter board, and camera on a common base for strain relief.



Technical information on Xilinx Kria embedded boards

For information on Xilinx Kria embedded boards see www.xilinx.com/products/som

Connecting the embedded board

In [Figure 10](#), the adapter board is flipped for a better view.

The board-to-board connectors (a, e) of the adapter board connect to the board-to-board connectors (c, d) of the embedded board.

1. Aligning the mounting holes (b, d), engage the board-to-board connectors to each other until you hear a light click.

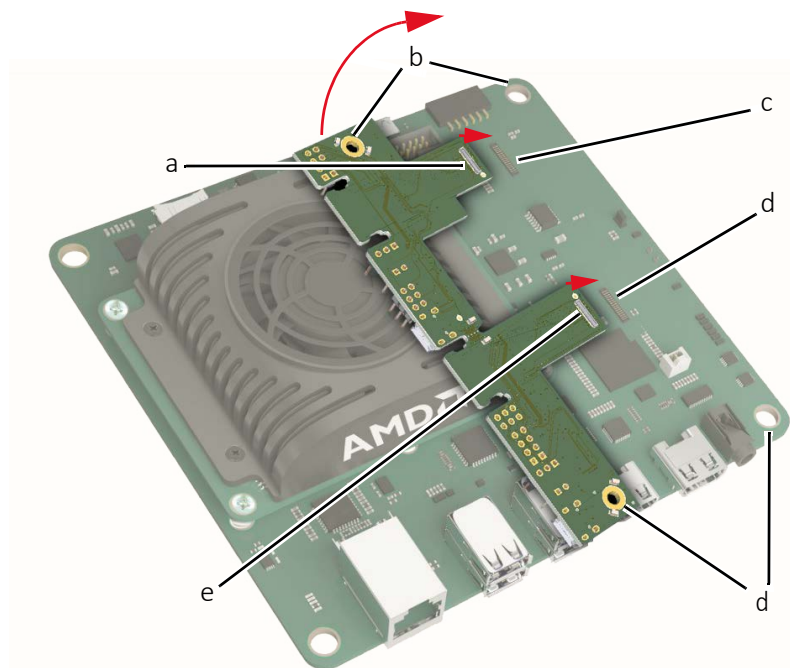

Figure 10: Connecting the adapter board to the embedded board

The adapter board is connected to the embedded board.

2. Continue by [Connecting the camera](#) on page 39.

Connecting the camera



Supported camera connectors

Only FPC camera connector J7 to IAS1 (h) is supported.

The FPC camera connector J7 to IAS0(f) is not supported.

1. Following the instructions in [Connecting FPC cables to Hirose FPC connectors](#) on page 35, connect the FPC cable to the FPC camera connector to IAS1(h).
2. Secure the cable by a cable tie around the mounting area (g) for strain relief.
3. Connect the other end of the FPC cable to the camera.

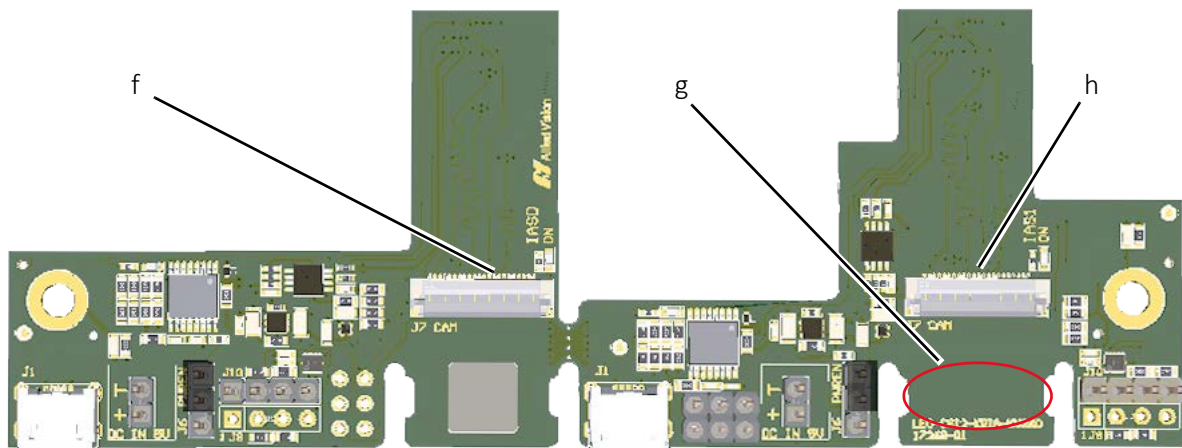

Figure 11: FPC camera connectors of the adapter board (top view)

Your Alvim CSI-2 camera is connected to the embedded board.

4. Continue by [Connecting USB power](#) on page 40.

Connecting USB power

We recommend you to power the camera using USB power.



NOTICE

Damage to power supplies

If power supplies do not provide sufficient current, they may be damaged.

Ensure USB power supplies provide 1.5 A. Depending on the camera model and the intensity of use of the camera by your application, the power consumption may be lower.

1. Ensure the USB power supply is disconnected from the mains power.
2. Connect the power supply's output connector to one of the two USB 2.0 Micro B receptacles (h).

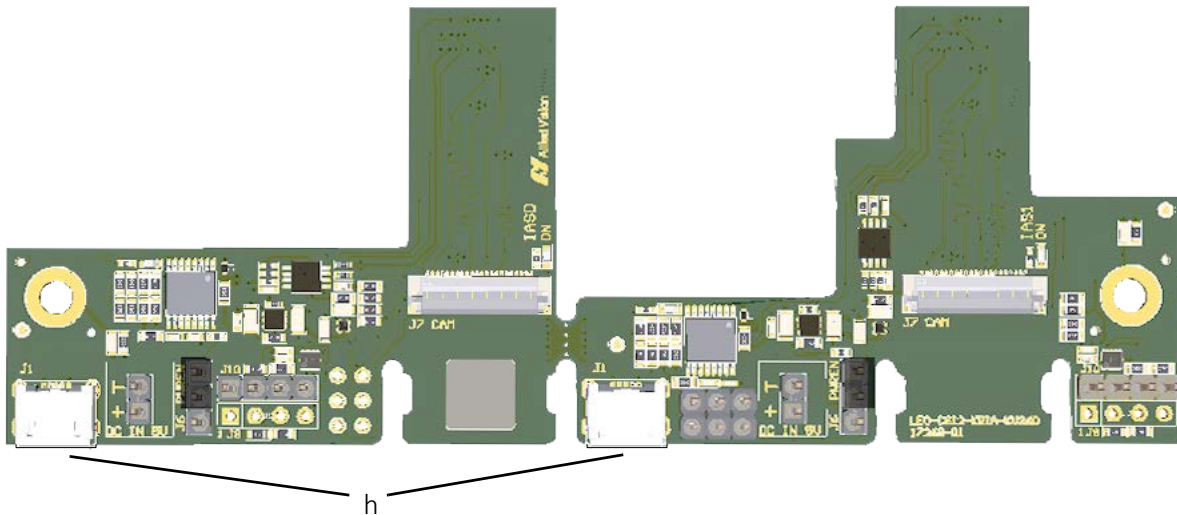

Figure 12: USB power connectors of the adapter board

3. Connect the power supply to the mains power.
4. Power and boot the embedded board.

Your Alvim CSI-2 camera can be operated via the embedded board.

5. Continue by [Connecting the I/Os](#) on page 41.

Connecting the I/Os

If you want to use the I/O lines of the **adapter board**, see the following instruction. This way, you reduce signal latencies, such as for triggering the camera by a light barrier.



About this instruction

This is a best-practice solution. Please visit www.alliedvision.com/en/about-us/contact-us/technical-support-repair-/rma if you have any questions.

The camera is connected to the embedded board by FPC connector J7 (IAS1) (n).

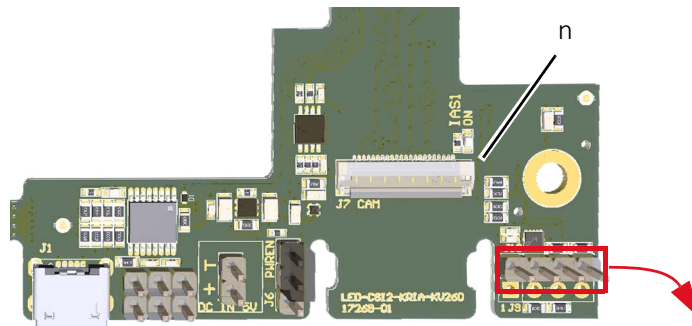

Figure 13: Camera connection to IAS1

1. On the pin header of connector J6, set the jumper to **position o** for camera ON when the system is powered, or to **position p**, if you want the embedded board to control camera power by the GPIO, see [Electronic schematics](#) on page 32.
2. On the pin header (q) of connector J10, use the I/O pins defined in [I/O signal levels and description](#) on page 42.

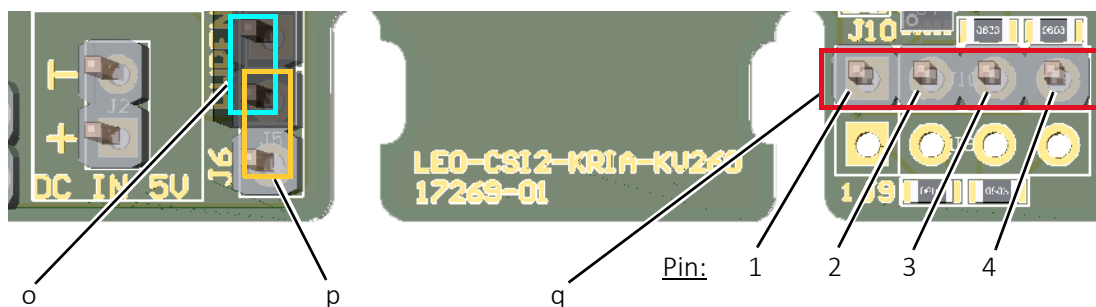

Figure 14: Connecting the I/Os for camera connection to IAS1

3. Continue by [Connecting ground](#).

Connecting ground

Connect GND to pin 2 (r) of connector J2.

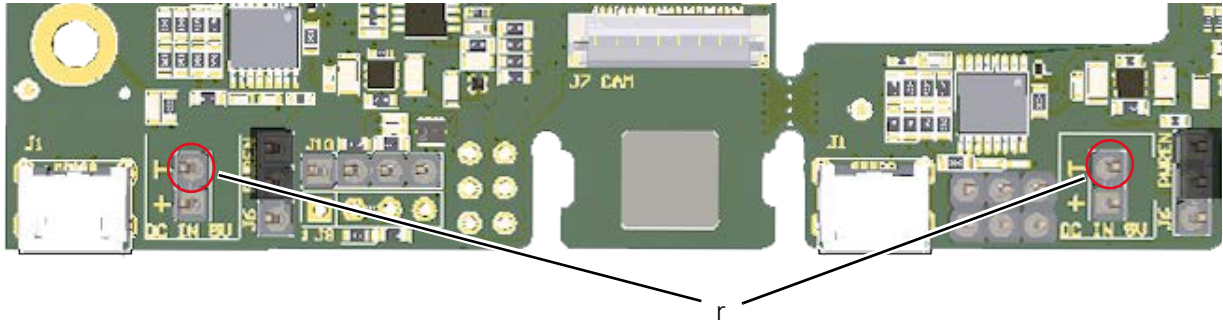

Figure 15: Ground connectors of the adapter board

Your embedded vision system is prepared for operation.

I/O signal levels and description

Table 5 displays the signals for the GPIOs on connector J10, for GND on connector J2, and for VCC-EXT-IN on the USB connector J1.

Connector	Pin	Signal	< - >	Level	Description
J1	1	VCC-EXT-IN	PWR IN	4.5 to 5.5 VDC	USB power supply
J1	5	GND	PWR	0 VDC	USB power supply ground
J2	1	VCC-EXT-IN	PWR IN	4.5 to 5.5 VDC	Power supply
J2	2	GND	PWR	0 VDC	Power supply ground
J10	1	EXT-GPIO2	IN/OUT	$U_{in} (low) = -0.3 \text{ to } 0.8 \text{ VDC}$ $U_{in} (high) = 2.0 \text{ to } 5.5 \text{ VDC}$ $U_{out} (low) = 0 \text{ to } 0.4 \text{ VDC}$ $U_{out} (high) = 2.4 \text{ to } 3.3 \text{ VDC}$ at max. 12 mA	GPIO Internal pull-up resistor: 33 k Ω to 63 k Ω
J10	2	GPIO2_3V3	IN/OUT	$U_{in} (low) = 0 \text{ to } 1.2 \text{ VDC}$ $U_{in} (high) = 2.2 \text{ to } 5.5 \text{ VDC}$ $U_{out} (low) = 0 \text{ to } 0.4 \text{ VDC}$ $U_{out} (high) = 2.9 \text{ to } 3.3 \text{ VDC}$ at max. 50 mA	GPIO Keep external pull-up or pull-down resistor above 50 k Ω
J10	3	EXT-GPIO3			See EXT-GPIO2
J10	4	GPIO3_3V3			See GPIO2_3V3

Table 5: I/O connections from the adapter board to the camera