



## MIPI CSI-2 CAMERAS

# Alvium CSI-2 Cameras User Guide

This user guide applies to Alvium 1500 C and 1800 C cameras, and it is the basic reference for Alvium FP3/GM2 cameras. For individual information on Alvium FP3/GM2 cameras, especially interface descriptions and instructions, please see the **Alvium FP3/GM2 User Guide** at [www.alliedvision.com/en/support/technical-documentation/alvium-csi-2-documentation](http://www.alliedvision.com/en/support/technical-documentation/alvium-csi-2-documentation).

Note: Lenses are not part of this product.

# V3.6.1

FW 00.13.00.e83c9689

**Quick links**

- [Alvium CSI-2 cameras at a glance](#) on page 15
- [Contact us](#) on page 23
- [Contents](#) on page 24

# Read before use

## EN - English

### Safety

Before using the camera, read these safety instructions. Observe the warnings at all times. Use the camera only as stated in the [Intended use](#) on page 53.

**CAUTION****Risk of burns**

A camera in operation can reach temperature levels which could cause burns.

**CAUTION****Injury by falling cameras or lenses**

A falling camera or lens can cause injury.

**CAUTION****Risk of cuts by sharp edges**

The product can have sharp edges.

### Intended use

Intended use of Allied Vision product is the integration into vision systems by professionals. All Allied Vision product is sold in a B2B setting.

### Cameras without closed housings

Cameras without housing or with incomplete housing must be shielded against EMC emission by professionals according to local EMC provisions.

## DA - Dansk

### Sikkerhed

Læs sikkerhedsanvisningerne, før kameraet bruges. Overhold alle advarsler. Brug kun kameraet som anført i [Intended use](#) på side 53.



#### FORSIGTIG

##### Forbrændingsfare

Når kameraet bruges, kan det blive meget varmt og forårsage forbrændinger.



#### FORSIGTIG

##### Kvæstelser, hvis kameraet eller linser falder ned

Falder kameraet eller linsen ned, kan dette forårsage kvæstelser.



#### FORSIGTIG

##### Fare for skarpe kanter

Produktet kan have skarpe kanter.

### Tilsligtet brug

Allied Vision produktets tilsligtede brug er en indbygning i et visionssystem, udført af fagfolk. Alle Allied Vision produkter sælges i B2B.

### Kameraer uden lukket hus

Kameraer uden hus eller uden komplet hus skal beskyttes mod EMC emissioner iht. lokale EMC bestemmelser.

## DE - Deutsch

### Sicherheit

Bevor Sie die Kamera benutzen, lesen Sie diese Sicherheitshinweise. Beachten Sie diese Hinweise immer. Verwenden Sie die Kamera nur wie beschrieben in [Intended use](#) auf Seite 53.



#### VORSICHT

##### **Gefahr von Verbrennungen**

Im Betrieb kann die Kamera Temperaturen erreichen, die zu Verbrennungen führen.



#### VORSICHT

##### **Verletzung durch fallende Kameras oder Objektive**

Eine fallende Kamera oder ein fallendes Objektiv kann Verletzungen verursachen.



#### VORSICHT

##### **Schnitte durch scharfe Kanten**

Das Produkt kann scharfe Kanten haben.

### Bestimmungsgemäßer Gebrauch

Allied Vision Produkte sind bestimmt für die Integration in Bildverarbeitungssysteme durch Fachpersonal. Alle Allied Vision Produkte werden in einer B2B-Umgebung verkauft.

### Kameras ohne geschlossenes Gehäuse

Für Kameras ohne Gehäuse oder mit unvollständigem Gehäuse muss die Abschirmung gegen EMV-Emissionen gemäß den örtlichen EMV-Bestimmungen durchgeführt werden.

## ES - Español

### Seguridad

Antes de utilizar la cámara lea estas instrucciones de seguridad. Observe las advertencias en todo momento. Utilice la cámara solo tal y como se estipula en el [Intended use](#) en la página 53.



#### ATENCIÓN

##### Riesgo de quemaduras

Una cámara en funcionamiento puede alcanzar temperaturas que podrían provocar quemaduras.



#### ATENCIÓN

##### Lesiones en caso de que las cámaras o las lentes se caigan

Si una cámara o una lente se cae puede provocar lesiones.



#### ATENCIÓN

##### Riesgo de cortes por bordes afilados

El producto puede tener bordes afilados.

### Uso previsto

El uso previsto del producto Allied Vision es la integración en el sistema de visión por parte de profesionales. Todos los productos Allied Vision se venden dentro de una relación B2B.

### Cámaras sin carcasa cerrada

Las cámaras sin carcasa o con una carcasa incompleta deben protegerse contra las emisiones CEM por parte de profesionales de acuerdo con las disposiciones locales sobre la CEM.

## FI - Suomi

### Turvallisuus

Lue nämä turvallisuusohjeet ennen kameran käyttöä. Noudata varoituksia joka hetki. Käytä kameraa ainoastaan kohdassa [Intended use](#) sivulla 53 kuvatulla tavalla.



#### HUOMIO

##### Palovammojen vaara

Käytössä olevan kameran saavuttamat lämpötilatasot voivat aiheuttaa palovammoja.



#### HUOMIO

##### Putoavien kameroiden tai linssien aiheuttamat vammat

Putoava kamera tai linssi voi aiheuttaa vammoja.



#### HUOMIO

##### Terävien reunojen aiheuttama viiltovaara

Tuotteessa voi olla teräviä reunoja.

### Käyttötarkoitus

Allied Vision-tuotteen käyttötarkoitus on integrointi kuvajärjestelmiin ammattilaisten toimesta. Kaikki Allied Vision-tuotteet myydään B2B-ympäristössä.

### Kamerat, joissa ei ole suljettuja koteloita

Ammattilaisten on suojattava kamerat, joissa ei ole koteloa tai joiden kotelo on epätäydellinen, EMC-päästöiltä paikallisten EMC-määräysten mukaisesti.

## FR - Français

### Sécurité

Veillez lire ces consignes de sécurité avant d'utiliser la caméra. Respectez continuellement les avertissements. Utilisez la caméra uniquement comme indiqué sous [Intended use](#), page 53.



#### ATTENTION

##### Risque de brûlures

Une caméra en service peut atteindre des niveaux de température susceptibles d'entraîner des brûlures.



#### ATTENTION

##### Blessures en cas de chute de caméras ou d'objectifs

La chute d'une caméra ou d'un objectif peut entraîner des blessures.



#### ATTENTION

##### Risque de coupures sur des bords tranchants

Le produit peut présenter des bords tranchants.

### Utilisation prévue

L'utilisation prévue du produit Allied Vision est son intégration dans des systèmes de vision par le soin de professionnels. Tout produit Allied Vision est vendu dans un cadre B2B.

### Caméras sans boîtier fermé

Les caméras sans boîtier fermé ou à boîtier incomplet doivent être blindées contre les émissions CEM par le soin de professionnels conformément aux dispositions CEM locales.

## עברית - HE

### בטיחות

לפני השימוש במצלמה, עליך לקרוא את הוראות הביטחון האלו. עליך לממש הוראות ביטחון אלו תמיד. השימוש במצלמה הוא רק לפי מה שכתוב ב"כוונת השימוש" (Intended use) בעמוד 53.

#### זהירות

##### סכנת כוויה

בזמן הפערת המצלמה עלולות טמפרטורות גבוהות לעלות, שיכולות לגרום לכוויות.



#### זהירות

##### פגיעה מנפילת מצלמות או עדשות

מצלמה או עדשה שנופלות עלולות לגרום לפגיעה.



#### זהירות

##### סכנת חתכים על ידי קצוות חדים

למוצר יכולים להיות קצוות חדים.



### שימוש מיועד

מוצרי AlliedVision מיועדים לשילוב במערכות ממוחשבת לעיבוד צילומים ע"י אנשי מקצוע. כל מוצרי AlliedVision נמכרים לשימוש בסביבת B2B.

### מצלמות ללא מארז סגור

מצלמות ללא מארז, או עם מארז חלקי בלבד, חייבות להיות מוגנות בפני קרינה אלקטרומגנטית (EMC) על ידי אנשי מקצוע בהתאם לתקנים המקומיים (EMC).



## IT - Italiano

### Sicurezza

Leggere queste istruzioni per la sicurezza prima di utilizzare la telecamera. Osservare sempre tutte le avvertenze. Utilizzare la telecamera come descritto alla sezione [Intended use](#) a pagina 53.



#### ATTENZIONE

##### **Pericolo di ustioni**

Durante il funzionamento una telecamera può raggiungere temperature elevate che possono essere causa di ustioni.



#### ATTENZIONE

##### **Lesioni dovute alla caduta di telecamere o lenti**

La caduta di una telecamera o di una lente può causare delle lesioni.



#### ATTENZIONE

##### **Pericolo di tagliarsi sui bordi affilati**

I bordi del prodotto lente possono essere affilati.

### Uso previsto

Il prodotto Allied Vision è concepito per essere integrato in sistemi di monitoraggio in campo professionale. Tutti i prodotti Allied Vision sono venduti in uno scenario B2B.

### Telecamere senza custodia chiusa

Le telecamere senza custodia o con una custodia incompleta devono essere protette dalle emissioni elettromagnetiche in ambienti professionali in conformità con le norme CEM nazionali.

## JA - 日本語

### 安全性

本カメラを使用する前に、この安全の手引きをお読みください。常に、警告事項を守ってください。必ず、[Intended use](#) 53 ページの通りに、本カメラを使用してください。



#### 注意

##### やけどの危険性

作動中のカメラは、やけどを引き起こす温度まで熱くなる恐れがあります。



#### 注意

カメラまたはレンズの落下によるけが  
カメラまたはレンズが落下すると、けがをする恐れがあります。



#### 注意

##### な端部で切り傷の危険性

本製品には鋭利な部分がある場合があります。

### 用途

Allied Vision製品は、専門家が視覚装置に統合することを意図したものです。すべてのAllied Vision製品は、企業間取り引き用に販売されています。

### ハウジングで閉じられていないカメラ

ハウジングのないカメラまたはハウジングが不完全なカメラは、現地の電磁両立性 (EMC) 規定に従い、専門家によって、EMCエミッションから保護される必要があります。

## NL - Nederlands

### Veiligheid

Lees deze veiligheidsinstructies voordat u de camera gaat gebruiken. Neem deze waarschuwingen altijd in acht. Gebruik de camera uitsluitend, zoals aangegeven in het [Intended use](#) op pagina 53.



#### VOORZICHTIG

##### Risico van verbranding

Een camera die gebruikt wordt, kan temperatuurwaarden bereiken die brandwonden kunnen veroorzaken.



#### VOORZICHTIG

##### Letsel door vallende camera's of lenzen

Een vallende camera of lens kan letsel veroorzaken.



#### VOORZICHTIG

##### Risico van snijwonden door scherpe randen

Het product kan scherpe randen hebben.

### Beoogd gebruik

Het beoogde gebruik van het Allied Vision-product is de integratie in optische systemen door professionals. Alle Allied Vision-producten worden verkocht in de B2B-markt.

### Camera's zonder gesloten behuizing

Camera's zonder behuizing of met een onvolledige behuizing moeten door professionals worden beschermd tegen EMC-straling door EMC-beschermingen ter plaatse.

## NO - Norsk

### Sikkerhet

Les disse sikkerhetsinstruksene før du bruker kameraet. Følg advarslene til en hver tid. Bruk kun kameraet i samsvar med [Intended use](#) på side 53.



#### FORSIKTIG

##### Risiko for brannskader

Et kamera i bruk kan nå temperaturnivåer som kan forårsake brannskader.



#### FORSIKTIG

##### Skade ved fallende kameraer eller linser

Et fallende kamera eller en fallende linse kan forårsake skade.



#### FORSIKTIG

##### Risiko for kutt fra skarpe kanter

Produktet kan ha skarpe kanter.

### Tiltenkt bruk

Den tiltenkte bruken av Allied Vision-produktet er integrering i visjonssystemer av profesjonelle. Alle Allied Vision-produkter selges i en forretning til forretning-situasjon.

### Kameraer uten lukkede kamerahus

Kameraer uten kamerahus eller med ufullstendige kamerahus må beskyttes mot EMC-utslipp av fagfolk i henhold til lokale EMC-bestemmelser.

## SV - Svenska

### Säkerhet

Läs igenom säkerhetsinstruktionerna innan du använder kameran. Var hela tiden särskilt uppmärksam på varningarna. Använd enbart kameran på det sätt som anges i [Intended use](#) på sida 53.



#### **VARNING**

##### **Risk för brännskada**

En kamera i drift kan komma upp i temperaturer som kan orsaka brännskador.



#### **VARNING**

##### **Risk för skador från fallande kameror eller objektiv**

Fallande kameror eller objektiv kan förorsaka skador.



#### **VARNING**

##### **Risk för skärsår från vassa kanter**

Produkten kan ha vassa kanter.

### Avsedd användning

Den avsedda användningen av Allied Vision-produkter är integrering i visionssystem av fackmän. Samtliga Allied Vision-produkter säljs i en B2B-miljö.

### Kameror utan slutna kamerahus

Kameror utan eller med ofullständiga kamerahus måste skyddas mot elektromagnetiska emissioner av fackmän enligt lokala bestämmelser för elektromagnetiska emissioner.

## ZH – 简体中文版

### 安全需知

使用本相机前，请阅读本安全说明书。请务必遵守相关警告 和 [Intended use](#) 于第 53 页。



#### 注意事项

##### 烫伤风险

相机操作过程中温度可能上升并导致烫伤风险。



#### 注意事项

##### 相机或者镜头跌落造成伤害

相机或者镜头可能会跌落并造成伤害。



#### 注意事项

##### 锋利边缘割伤的风险

产品可能有锋利的边缘。

### 预期用途

Allied Vision 产品的预期用途是由专业人士整合到视觉系统中。所有 Allied Vision 的产品均通过 B2B 渠道销售。

### 无封闭式外壳相机

使用不带外壳或外壳不完整的相机时，必须由专业人员根据当地的 EMC 规定，对其进行 EMC 屏蔽。

# Alvium CSI-2 cameras at a glance



Get an overview of Alvium CSI-2 camera documentation:

Notes .....	16
Consider for Alvium CSI-2 cameras.....	16
Shipping contents.....	16
What else do you need? .....	17
Alvium FP3/GM2- extending CSI-2 .....	18
Alvium Flex- more flexibility .....	19
Alvium Frame- use your own optical mount .....	21
Alvium Pol- using polarization (coming soon) .....	22

## Notes



### Read this document carefully

Learn to avoid damage to your Alvium CSI-2 camera and use it in the most safe and efficient way.



### NOTICE

#### Damage to camera and embedded hardware by improper handling

Setup and operation for Alvium CSI-2 cameras in embedded systems is different than for cameras in PC-based systems. Components can easily be damaged.

- If you are unfamiliar with embedded systems, be extremely careful.
- Follow the safety notes.
- Follow the instructions in [Installing the hardware](#) on page 251.

## Consider for Alvium CSI-2 cameras

Please read the following to better understand your Alvium CSI-2 camera and to setup your application smoothly:

- **Direct Register Access, Video4Linux Access, GenICam for CSI-2 Access:** [Access modes](#) on page 246
- [Exposure time and frame rates](#) on page 70
- Alvium CSI-2 characteristics: [Performance](#) on page 290
- [User sets](#) on page 225, including supported features, also for triggering
- [Bare board cameras](#) on page 252.



### Vimba X

We recommend you to use **Vimba X** to enable the full feature range and proper operation.

**Vimba X Firmware Updater** included in **Vimba X** can be used to update any firmware version.

You can download **Vimba X** from [www.alliedvision.com/en/products/software/vimba-x-sdk](http://www.alliedvision.com/en/products/software/vimba-x-sdk).



### Maximum frame rates with SensorBitDepth

Alvium 1800 C models that support **SensorBitDepth** can run higher frame rates than with ADC bit depth. These values will be added for 1800 C-030 VSWIR, -040, -052, -130 VSWIR, -158, -240, -291, -508 in a future version of this document.

## Shipping contents

- Alvium CSI-2 camera
- Download Instructions for First Camera Operation document



## What else do you need?

This is a selection of helpful downloads:



Item	Download	Link
<b>Extended hardware options</b>		
	<b>Alvium Modular Concept</b> for, such as Alvium Flex or Frame	<a href="http://www.alliedvision.com/en/support/technical-documentation/alvium-csi-2-documentation">www.alliedvision.com/en/support/technical-documentation/alvium-csi-2-documentation</a>
<b>Controls and features</b>		
	Alvium CSI-2 Register Controls Reference	<a href="http://www.alliedvision.com/en/support/technical-documentation/alvium-csi-2-documentation">www.alliedvision.com/en/support/technical-documentation/alvium-csi-2-documentation</a>
	Alvium Features Reference	<a href="http://www.alliedvision.com/en/support/technical-documentation/alvium-csi-2-documentation">www.alliedvision.com/en/support/technical-documentation/alvium-csi-2-documentation</a>
<b>Applications</b>		
	Application notes	<a href="http://www.alliedvision.com/en/support/technical-documentation/alvium-csi-2-documentation">www.alliedvision.com/en/support/technical-documentation/alvium-csi-2-documentation</a>
<b>Software downloads</b>		
	Driver for Alvium CSI-2 cameras, code examples, and more	<a href="http://www.alliedvision.com/en/products/software/embedded-software-and-drivers">www.alliedvision.com/en/products/software/embedded-software-and-drivers</a>
	<b>Vimba X SDK</b> for Windows, Linux, and Linux/ARM, including <b>Vimba X Viewer, Firmware Updater,</b> and <b>Driver Installer</b> for Windows	<a href="http://www.alliedvision.com/en/products/software/vimba-x-sdk">www.alliedvision.com/en/products/software/vimba-x-sdk</a>
<b>Firmware update</b>		
	Firmware downloads	<a href="http://www.alliedvision.com/en/support/firmware-downloads">www.alliedvision.com/en/support/firmware-downloads</a>
<b>STEP files</b>		
	STEP files downloads	Downloads for standard Alvium CSI-2 models: <a href="http://www.alliedvision.com/en/camera-selector">www.alliedvision.com/en/camera-selector</a> Downloads for Alvium Flex or Frame: <a href="http://www.alliedvision.com/en/support/alvium-step-file-downloads">www.alliedvision.com/en/support/alvium-step-file-downloads</a>
	Assembling Alvium Cameras from CAD Component (application note)	<a href="http://www.alliedvision.com/en/support/technical-documentation/alvium-csi-2-documentation">www.alliedvision.com/en/support/technical-documentation/alvium-csi-2-documentation</a>
<b>Accessories</b>		
	<b>Accessories</b> , such as interface cables and cards, power and I/O cables, power supplies, lenses, and tripod adapters	<a href="http://www.alliedvision.com/en/products/accessories">www.alliedvision.com/en/products/accessories</a>

Table 1: Downloads for Alvium CSI-2 cameras

# Alvium FP3/GM2 - extending CSI-2

Alvium FP3/GM2 cameras extend the range of applications for Alvium CSI-2.



Figure 1: Alvium FP3 or Alvium GM2 camera

## Interface cable length

Alvium 1500 C and 1800 C cameras support a maximum cable length of 420 mm for FPC cables connecting to the MIPI CSI-2 interface. Alvium FP3 and Alvium GM2 cameras enable vision applications with cable lengths up to **10 m for STP** and up to **15 m for Coax models**.

## Housing options

Alvium 1500 C and 1800 C are available as bare board and open housing with C-Mount, CS-Mount, or S-Mount. Alvium FP3/GM2 cameras are offered as **closed housing** with the same lens mount options.

## Supported sensor models

**Every CSI-2 model** is offered as FP3/GM2. For example, analog to Alvium 1800 C-240, Alvium FP3-240 and Alvium GM2-240 models are available.

## Controls and features

Alvium FP3/GM2 cameras support **the same** V4L2 controls or GenICam features as 1500 C or 1800 C.

## Hardware components

Alvium FP3/GM2 cameras, with an on-board serializer, connect to deserializer boards by FAKRA coaxial cables or by HSD STP cables. Deserializer boards connect to adapter boards or embedded boards by FPC cables.

## Documentation

The **Alvium CSI-2 Cameras User Guide** is the basic reference for Alvium FP3/GM2, for all properties shared with Alvium 1500 C and 1800 C.

In addition, the **Alvium FP3/GM2 User Guide** provides:

- Differences in specifications
- Instructions for basic operation
- Interface descriptions.



## Alvium FP3/GM2 User Guide and accessories

You can find the Alvium FP3/GM2 User Guide at [www.alliedvision.com/en/support/technical-documentation/alvium-csi-2-documentation/](http://www.alliedvision.com/en/support/technical-documentation/alvium-csi-2-documentation/).

For deserializer boards, FAKRA coaxial cables or STP cables, for adapter boards and FPC cables, see [www.alliedvision.com/en/products/accessories](http://www.alliedvision.com/en/products/accessories).

## Alvium Flex - more flexibility

Hardware options for standard Alvium cameras support various digital interfaces, housings, and lens mounts to enable a wide range of applications.

You have found that Alvium CSI-2 cameras with Hirose FH55-22S-0.5SH FPC connector do not offer enough flexibility for your application? You want to use your own cables and connectors?

Alvium Flex cameras with Hirose DF40C-50DP-0.4V board-to-board connector enable individual connections. Alvium Flex accessories can be used for developing and first testing. [Figure 2](#) shows how Add-on Boards connect to Alvium Flex cameras.

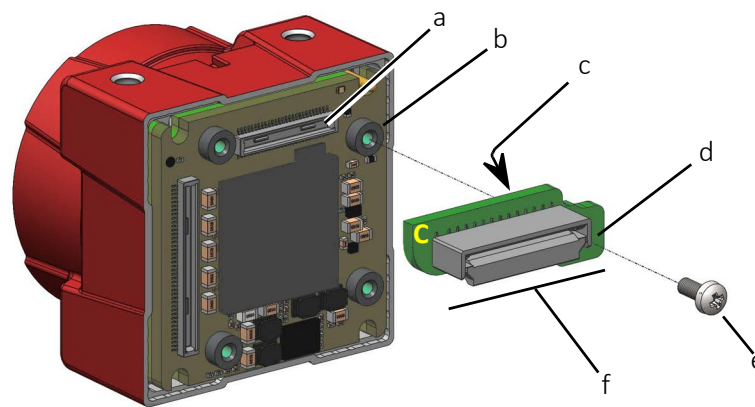

*Figure 2: Alvium Flex camera, Interface Board, and screw*

- a: Hirose DF40C-50DP-0.4V camera connector
- b: Mounting thread
- c: Hirose DF40C-50DS-0.4V board connector
- d: Mounting hole
- e: Fastening screw
- f: Add-on Board

## Alvium CSI-2 Flex

The following options are offered for **Alvium CSI-2 Flex** cameras. Above developing and testing, Alvium Flex adds flexibility to **standard Alvium CSI-2** cameras.

### Individual solutions

Hirose DF40 board-to-board connector enables individual connections to your own boards and cables.

## Off-the-shelf solution

Alvium CSI-2 Flex accessories enhance existing applications based on Hirose FH55 connector. As an alternative, the Add-on Board with a Hirose TF38 connector can be used. It connects the cable tightly and perpendicular to the camera back plane. For the setup shown in [Figure 3](#), FPC cables connect in a straight line without bending:

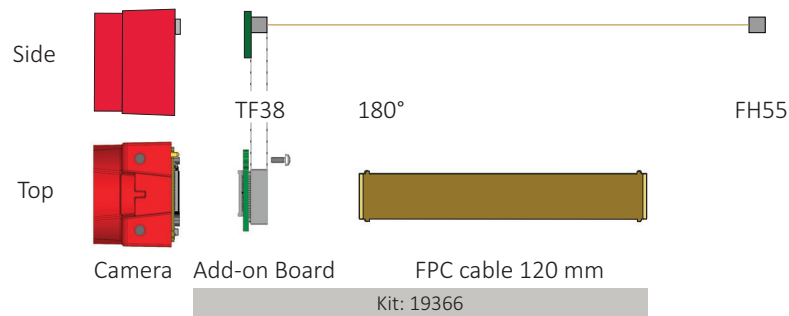

Figure 3: **Alvium CSI-2 Flex** camera connection

### Alvium Flex cameras

See contents in [Specifications](#) on page 64 and in [Camera interfaces](#) on page 266.



#### Alvium Flex accessories and instructions

See the Alvium Flex Design and Accessory Guide at [www.alliedvision.com/en/support/technical-documentation/alvium-csi-2-documentation](http://www.alliedvision.com/en/support/technical-documentation/alvium-csi-2-documentation).



#### Ordering Alvium Flex cameras

See the Alvium Modular Concept at [www.alliedvision.com/en/support/technical-documentation/alvium-csi-2-documentation](http://www.alliedvision.com/en/support/technical-documentation/alvium-csi-2-documentation).



#### Alvium Frame Flex

You can combine hardware options for Alvium CSI-2 Frame Flex cameras.

## Alvium Frame - use your own optical mount

You want to design your own lens mount for Alvium CSI-2 cameras or your application does not need a lens mount? In this case, Alvium Frame adds more flexibility. The square front flange with only 10 mm depth aligns to your individual housing with an extremely high accuracy.

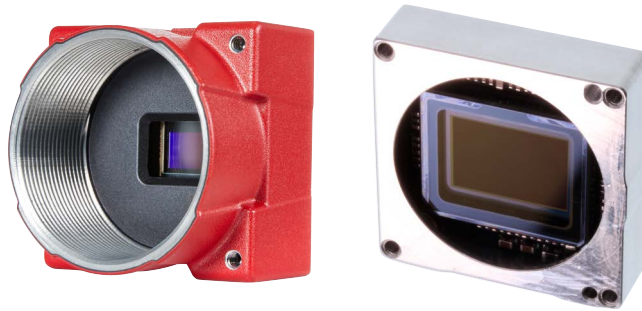

Figure 4: Standard Alvium CSI-2 open housing (left) vs. Alvium CSI-2 Frame (right)

### Specifications

- [Alvium Frame: Dimensions and mass](#) on page 218
- [Alvium Frame: Technical drawings](#) on page 218
- [Housed Alvium Frame: Sensor shift and rotation](#) on page 223

### Instructions

- [Mounting Alvium Frame](#) on page 259
- [Aligning the sensor with your optical system](#) on page 260
- [Mounting Alvium Frame](#) on page 261



#### Ordering Alvium Frame cameras

See the Alvium Modular Concept at [www.alliedvision.com/en/support/technical-documentation/alvium-csi-2-documentation](http://www.alliedvision.com/en/support/technical-documentation/alvium-csi-2-documentation).



#### Alvium Frame Flex

You can combine hardware options for Alvium CSI-2 Frame Flex cameras.

## Alvium Pol - using polarization (coming soon)

Alvium polarizer cameras are equipped with Sony IMX Polarsens sensors that support four-directional polarization using filters directly in front of the sensor. With these cameras, you can replace additional polarizer filters on the lens used in typical applications. In many cases, polarizer sensors can adapt easily to setups with varying polarization angles; there is no need to change or rotate optical polarization filters anymore.

You can use polarized light imaging, for example, to reduce reflections or for surface analysis regarding stress and defects. [Figure 5](#) shows how the orientation of the polarization filters affects brightness values for the sub-images:



*Figure 5: Polarization angle versus image brightness in sub-images*

Current models:

- [Alvium 1800 C-507m/c Pol \(coming soon\)](#) on page 146
- [Alvium 1800 C-508m/c Pol \(coming soon\)](#) on page 153



### Please observe

For first series models, pixel processing has not been adjusted to enable the complete functionality available with non-polarizer models:

- Only raw pixel formats are supported, but no formats for polarizer sensors.
- Features based on pixel processing are available but cannot be used to generate a proper output. For example, color processing, binning, convolution filter, DPC, or FPNC are not supported.



### More information

See the Pixel based polarizer application note at [www.alliedvision.com/en/support/technical-documentation/alvium-usb-documentation](http://www.alliedvision.com/en/support/technical-documentation/alvium-usb-documentation).

# Contact us

## Website, email

### General

[www.alliedvision.com/en/contact](http://www.alliedvision.com/en/contact)  
[info@alliedvision.com](mailto:info@alliedvision.com)

### Distribution partners

[www.alliedvision.com/en/avt-locations/avt-distributors](http://www.alliedvision.com/en/avt-locations/avt-distributors)

### Support

[www.alliedvision.com/en/support](http://www.alliedvision.com/en/support)  
[www.alliedvision.com/en/about-us/contact-us/technical-support-repair-/rma](http://www.alliedvision.com/en/about-us/contact-us/technical-support-repair-/rma)

## Offices

### Europe, Middle East, and Africa (Headquarters)

Allied Vision Technologies GmbH  
Taschenweg 2a  
07646 Stadtroda, Germany  
T// +49 36428 677-0 (Reception)  
T// +49 36428 677-230 (Sales)  
F// +49 36428 677-28

### Asia-Pacific

#### China

Allied Vision Technologies  
(Shanghai) Co., Ltd.  
2-2109 Hongwell Int. Plaza  
1602# ZhongShanXi Road  
Shanghai 200235, China  
T// +86 21 64861133

#### Singapore

Allied Vision Technologies Asia Pte. Ltd  
82 Playfair Rd, #07-01 D'Lithium  
Singapore 368001  
T// +65 6634 9027

### North, Central, and South America

#### Canada

Allied Vision Technologies Canada Inc.  
300 – 4621 Canada Way  
Burnaby, BC V5G 4X8, Canada  
T// +1 604 875 8855

#### USA

Allied Vision Technologies, Inc.  
102 Pickering Way- Suite 502  
Exton, PA 19341, USA  
Toll-free// +1-877-USA-1394  
T// +1 978 225 2030

# Contents

<b>Read before use</b>	<b>2</b>
EN - English	2
DA - Dansk	3
DE - Deutsch	4
ES - Español	5
FI - Suomi	6
FR - Français	7
HE - עברית	8
IT - Italiano	9
JA - 日本語	10
NL - Nederlands	11
NO - Norsk	12
SV - Svenska	13
ZH - 简体中文版	14
<b>Alvium CSI-2 cameras at a glance</b>	<b>15</b>
Notes	16
Consider for Alvium CSI-2 cameras	16
Shipping contents	16
What else do you need?	17
Alvium FP3/GM2 - extending CSI-2	18
Alvium Flex - more flexibility	19
Alvium CSI-2 Flex	19
Individual solutions	19
Off-the-shelf solution	20
Alvium Frame - use your own optical mount	21
Specifications	21
Instructions	21
Alvium Pol - using polarization (coming soon)	22
<b>Contact us</b>	<b>23</b>
<b>Document history and conventions</b>	<b>33</b>
Document history	34
Conventions used in this user guide	46
Typographic styles	46
Symbols and notes	47
GenICam for CSI-2 Access	48
Naming and terms	48
Controls and features	48
ROI and cropping	49
Camera model naming	49
Terms and acronyms	49
<b>Compliance, safety, and intended use</b>	<b>51</b>



Camera identification . . . . .	52
Compliance notifications . . . . .	52
Bare board and open housing cameras . . . . .	53
Avoid electromagnetic interferences . . . . .	53
Intended use . . . . .	53
Copyright and trademarks . . . . .	54
Your safety . . . . .	54
Handling lens mounts and Alvim Frame . . . . .	54
Housed cameras: handling hot cameras . . . . .	54
Providing optimum heat dissipation . . . . .	55
Camera mounting . . . . .	56
Heavy lenses . . . . .	56
Product safety . . . . .	56
Embedded systems . . . . .	56
Supported embedded boards . . . . .	56
Electrical connections . . . . .	57
ESD . . . . .	57
Cable connections . . . . .	57
PCBAs . . . . .	57
Camera power . . . . .	58
Ground loops . . . . .	58
Hirose FH55 and DF40C-50DP-0.4V connectors . . . . .	58
Hirose FH 55 FPC connectors . . . . .	59
MIPI CSI-2 FPC cables . . . . .	59
Handling bare board cameras . . . . .	60
Optical components . . . . .	60
Sensor . . . . .	61
Lenses . . . . .	62
Mechanical components . . . . .	62
Heat sinks . . . . .	62
Conductive media for heat sinks . . . . .	63
<b>Specifications . . . . .</b>	<b>64</b>
Applied standards . . . . .	65
GenICam . . . . .	65
MIPI CSI-2 . . . . .	65
V4L2 . . . . .	65
Shock and vibration . . . . .	65
IEC 60068-2-6: Sinusoidal vibration . . . . .	66
IEC 60068-2-27: Shock . . . . .	67
IEC 60068-2-64: Random vibration . . . . .	67
Notes on specifications . . . . .	68
Sensor . . . . .	68
Absolute QE plots . . . . .	68
Spectral response plots . . . . .	68
Pixel format default and naming . . . . .	69
GenICam for CSI-2 Access . . . . .	69
Other access modes . . . . .	69
Pixel formats for various standards . . . . .	69

Exposure time and frame rates . . . . .	70
Achieved values deviating from specified values . . . . .	70
CSI-2LaneCount and CSI-2ClockFrequency . . . . .	71
Dropped frames or a viewer issue? . . . . .	71
Frame rates with ROI/Cropping . . . . .	71
Sensor ADC readout modes for maximum frame rates . . . . .	72
Operation for maximum frame rates . . . . .	73
Exposure time behavior regarding ExposureMode. . . . .	73
Frame rates with rolling shutter sensors . . . . .	74
Brightness with 1800 C-812 UV cameras . . . . .	74
Sensor shutter types. . . . .	74
Digital binning . . . . .	75
Sensor binning. . . . .	75
Operation for medium power consumption . . . . .	75
Dimensions and mass. . . . .	75
Alvium 1500 C model specifications . . . . .	76
Alvium 1500 C-050m/c. . . . .	76
Absolute QE . . . . .	78
Spectral response. . . . .	78
Frame rates with Cropping . . . . .	79
Alvium 1500 C-120m/c. . . . .	80
Absolute QE . . . . .	82
Spectral response. . . . .	82
Frame rates with Cropping . . . . .	83
Alvium 1500 C-210m/c. . . . .	84
Absolute QE . . . . .	86
Spectral response. . . . .	86
Frame rates with Cropping . . . . .	87
Alvium 1500 C-500m/c. . . . .	88
Absolute QE . . . . .	90
Spectral response. . . . .	90
Frame rates with Cropping . . . . .	91
Alvium 1500 C-501m/c NIR . . . . .	92
Absolute QE . . . . .	94
Spectral response. . . . .	94
Frame rates with Cropping . . . . .	95
Alvium 1800 C model specifications . . . . .	96
Alvium 1800 C-030 VSWIR . . . . .	96
Absolute QE . . . . .	97
Frame rates with Cropping . . . . .	98
Alvium 1800 C-040m/c. . . . .	99
Absolute QE . . . . .	101
Spectral response. . . . .	101
Frame rates with Cropping . . . . .	102
Alvium 1800 C-052m/c. . . . .	103
Absolute QE, spectral response . . . . .	104
Frame rates with Cropping . . . . .	105
Alvium 1800 C-130 VSWIR . . . . .	106

Absolute QE .....	107
Frame rates with Cropping .....	108
Alvium 1800 C-158m/c.....	109
Absolute QE .....	111
Spectral response.....	111
Frame rates with Cropping .....	112
Alvium 1800 C-203m/c.....	113
Absolute QE, spectral response .....	114
ROI frame rates .....	115
Alvium 1800 C-234m/c.....	116
Absolute QE .....	118
Spectral response.....	118
ROI frame rates .....	119
Alvium 1800 C-235m/c.....	120
Absolute QE .....	122
Spectral response.....	122
ROI frame rates .....	123
Alvium 1800 C-240m/c.....	124
Absolute QE .....	126
Spectral response .....	126
Frame rates with Cropping .....	127
Alvium 1800 C-291m/c.....	128
Absolute QE, spectral response .....	129
Frame rates with Cropping .....	130
Alvium 1800 C-319m/c.....	131
Absolute QE .....	133
Spectral response.....	133
Frame rates with Cropping .....	134
Alvium 1800 C-320 VSWIR (coming soon) .....	135
Absolute QE, spectral response .....	136
Frame rates with Cropping .....	137
Alvium 1800 C-500m/c.....	138
Absolute QE .....	140
Spectral response.....	140
Frame rates with Cropping .....	141
Alvium 1800 C-507m/c.....	142
Absolute QE .....	144
Spectral response.....	144
Frame rates with Cropping .....	145
Alvium 1800 C-507m/c Pol (coming soon).....	146
Absolute QE, spectral response .....	147
Frame rates with Cropping .....	148
Alvium 1800 C-508m/c.....	149
Absolute QE .....	151
Spectral response.....	151
Frame rates with Cropping .....	152
Alvium 1800 C-508m/c Pol (coming soon).....	153
Absolute QE, spectral response .....	154

Frame rates with Cropping .....	155
Alvium 1800 C-510m/c .....	156
Absolute QE .....	158
Spectral response .....	158
Frame rates with Cropping .....	159
Alvium 1800 C-511m/c .....	160
Absolute QE .....	162
Spectral response .....	162
Frame rates with Cropping .....	163
Alvium 1800 C-530 VSWIR (coming soon) .....	164
Absolute QE, spectral response .....	165
Frame rates with Cropping .....	166
Alvium 1800 C-811m/c .....	167
Absolute QE .....	169
Spectral response .....	169
Frame rates with Cropping .....	170
Alvium 1800 C-812 UV .....	171
Absolute QE .....	173
Spectral response .....	173
Frame rates with Cropping .....	174
Alvium 1800 C-895m/c .....	175
Absolute QE, spectral response .....	176
Frame rates with Cropping .....	177
Alvium 1800 C-1236m/c .....	178
Absolute QE .....	180
Spectral response .....	180
Frame rates with Cropping .....	181
Alvium 1800 C-1240m/c .....	182
Absolute QE .....	184
Spectral response .....	184
Frame rates with Cropping .....	185
Alvium 1800 C-1242m/c .....	186
Absolute QE .....	188
Spectral response .....	188
Frame rates with Cropping .....	189
Alvium 1800 C-1620m/c .....	190
Absolute QE .....	192
Spectral response .....	192
Frame rates with Cropping .....	193
Alvium 1800 C-2040m/c .....	194
Absolute QE .....	196
Spectral response .....	196
Frame rates with Cropping .....	197
Alvium 1800 C-2050m/c .....	198
Absolute QE .....	200
Spectral response .....	200
Frame rates with Cropping .....	201
Alvium 1800 C-2460m/c .....	202

Absolute QE .....	204
Spectral response .....	204
Frame rates with Cropping .....	205
White balance default .....	206
Standard Alvium: Dimensions and mass .....	207
Standard Alvium: Technical drawings .....	208
Bare Board (standard Alvium) .....	208
Open Housing C-Mount (standard Alvium) .....	210
Open Housing CS-Mount (standard Alvium) .....	211
Open Housing S-Mount (standard Alvium) .....	212
Alvium Flex: Dimensions and mass .....	213
Alvium Flex: Technical drawings .....	213
Bare Board (Alvium Flex) .....	214
Open Housing C-Mount (Alvium Flex) .....	215
Open Housing CS-Mount (Alvium Flex) .....	216
Open Housing S-Mount (Alvium Flex) .....	217
Alvium Frame: Dimensions and mass .....	218
Alvium Frame: Technical drawings .....	218
Alvium Frame Flex: Dimensions and mass .....	219
Alvium Frame Flex: Technical drawings .....	219
Maximum protrusion for front mounts .....	220
IR cut filter .....	221
Sensor position accuracy .....	222
Housed standard and Flex cameras: Sensor shift and rotation .....	222
Housed Alvium Frame: Sensor shift and rotation .....	223
All housed Alvium CSI-2 cameras: Sensor tilt .....	223
User sets .....	225
Supported features .....	225
Trigger features and UserSetDefault .....	225
Camera feature availability .....	226
<b>Lenses: Focal length vs. field of view</b> .....	<b>229</b>
About this chapter .....	230
Parameters in tables .....	230
Optical vignetting with certain lenses .....	230
About S-Mount lenses .....	231
Focal length vs. field of view .....	231
Alvium 1500 C-050m/c .....	231
Alvium 1500 C-120m/c .....	232
Alvium 1500 C-210m/c .....	232
Alvium 1500 C-500m/c, -501m/c NIR .....	233
Alvium 1800 C-030 VSWIR .....	233
Alvium 1800 C-040m/c .....	234
Alvium 1800 C-052m/c .....	234
Alvium 1800 C-130 VSWIR .....	235
Alvium 1800 C-158m/c .....	235
Alvium 1800 C-203m/c .....	236
Alvium 1800 C-234m/c, -235m/c .....	236
Alvium 1800 C-240m/c .....	237

Alvium 1800 C-291m/c.....	237
Alvium 1800 C-319m/c, -320 VSWIR.....	238
Alvium 1800 C-320 VSWIR.....	238
Alvium 1800 C-500m/c.....	239
Alvium 1800 C-507m/c, -507m/c Pol, -508m/c, -508m/c Pol.....	239
Alvium 1800 C-510m/c, -511m/c.....	240
Alvium 1800 C-530 VSWIR.....	240
Alvium 1800 C-811m/c, -812 UV.....	241
Alvium 1800 C-895m/c.....	241
Alvium 1800 C-1236m/c.....	242
Alvium 1800 C-1240m/c.....	242
Alvium 1800 C-1242m/c.....	243
Alvium 1800 C-1620m/c.....	243
Alvium 1800 C-2040m/c.....	244
Alvium 1800 C-2050m/c.....	244
Alvium 1800 C-2460m/c.....	245
<b>Access modes</b>	<b>246</b>
Overview.....	247
Notes on GenICam for CSI-2 Access.....	247
Data flow.....	248
V4L2 controls and register controls.....	249
GenICam features.....	249
GenICam for CSI-2 Access - Camera operation.....	250
Need to restart the embedded board.....	250
Debouncer.....	250
Device reset.....	250
User sets.....	250
<b>Installing the hardware</b>	<b>251</b>
Touching hot cameras.....	252
Sensor damage by ESD.....	252
Scope of instructions.....	252
Software installation.....	252
Hardware installation.....	252
Bare board cameras.....	252
Serial numbers of Alvium® chips and bare board cameras.....	253
Connecting FPC cable and FPC connectors.....	254
Mounting the heat sink.....	256
Mounting the camera.....	257
Mounting bare board cameras.....	257
Mounting open housing cameras.....	258
Bottom or top mounting.....	258
Front mounting.....	259
Mounting Alvium Frame.....	259
Aligning the sensor with your optical system.....	260
Mounting Alvium Frame.....	261
Adapting maximum torque values.....	262
Mounting the lens.....	262

Mounting and focusing S-Mount lenses . . . . .	263
<b>Camera interfaces</b>	<b>266</b>
Standard Alvium and Alvium Frame: Connections . . . . .	267
Recommended accessories . . . . .	267
Back panel . . . . .	267
Hirose FH55 connector pin assignment . . . . .	268
Alvium Flex: Connections . . . . .	270
Observe for DF40C-50DP-0.4V connectors . . . . .	270
Back panel . . . . .	270
DF40C-50DP-0.4V connector details . . . . .	270
All Alvium CSI-2: Connections . . . . .	273
I/O use for UART . . . . .	273
Non-isolated, programmable GPIOs . . . . .	274
GPIOs description . . . . .	274
Input levels . . . . .	275
Output levels . . . . .	275
Status LED . . . . .	276
Normal operation . . . . .	276
Error conditions . . . . .	276
<b>Triggering and timings</b>	<b>277</b>
Availability of triggering controls for CSI-2 . . . . .	278
Trigger signal flow . . . . .	278
Trigger latency . . . . .	279
Trigger features and UserSetDefault . . . . .	279
Triggering with rolling shutter cameras . . . . .	279
Ignored triggers . . . . .	281
Trigger delay with 1500 C-120 cameras . . . . .	281
<b>Firmware update</b>	<b>282</b>
Please note . . . . .	283
Preparing firmware updates . . . . .	283
Updating the firmware . . . . .	284
Error handling . . . . .	286
<b>Image data flow</b>	<b>287</b>
Image data flow diagram . . . . .	288
FPNC support . . . . .	289
<b>Performance</b>	<b>290</b>
Image transfer with rolling shutter cameras . . . . .	291
Parameter changes . . . . .	291
Stopped streaming . . . . .	291
Frame rate jitter . . . . .	291
Value changes by control interdependencies . . . . .	292
Effects for the interdependent controls . . . . .	292
Impact by other controls . . . . .	293
Exposure times and frame rates with Sony IMX rolling shutter cameras . . . . .	293

Dark current compensation .....	293
Additional compensation .....	294
Black level compensation for 1500 C-050m/c .....	295
Shutter types affecting image readout .....	296
Index .....	297



# Document history and conventions



This chapter includes:

Document history .....	34
Conventions used in this user guide.....	46
Naming and terms .....	48

# Document history

Version	Date	Remarks
V3.6.1	2024-Mar-19	<p><b>Firmware version:</b> 00.13.00.e83c9689</p> <ul style="list-style-type: none"> <li>Added contents for <a href="#">Pixel format default and naming</a> on page 69 related to Video4Linux Access and Direct Register Access.</li> <li>Added QE curve for <a href="#">Alvium 1800 C-812 UV</a> on page 171.</li> <li>Applied editorial changes.</li> </ul>
V3.6.0	2024-Mar-05	<p><b>Firmware version:</b> 00.13.00.e83c9689</p> <ul style="list-style-type: none"> <li>Updated title image.</li> <li>Added introduction for <a href="#">Alvium Pol - using polarization (coming soon)</a> on page 22.</li> <li>Added contents for manufacturing conditions regarding <a href="#">Sensor cleanliness</a> on page 61.</li> <li>Added a note that the output bit depth affects the minimum available exposure times in <a href="#">Sensor ADC readout modes for maximum frame rates</a> on page 72.</li> <li>Added a note for <a href="#">Brightness with 1800 C-812 UV cameras</a> on page 74.</li> <li>Changed contents in <a href="#">Specifications</a> on page 64:               <ul style="list-style-type: none"> <li>Updated exposure time ranges and ROI frame rates.</li> <li>Added a note for ROI frame rates and exposure time ranges with Video4Linux Access and Direct Register Access.</li> <li>Increased maximum resolution with Alvium 1800 C-2050 from 5376 × 3672 to 5496 × 3672 pixels. (The higher resolution is available with GenICam for CSI-2 Access, the lower resolution is available with Video4Linux Access and with Direct Register Access.)</li> </ul> </li> <li>Changes to <a href="#">Specifications</a> on page 64 and in <a href="#">Lenses: Focal length vs. field of view</a> on page 229:               <ul style="list-style-type: none"> <li><b>Added models coming soon:</b> 1800 C-320 VSWIR, -530 VSWIR, -507 Pol, and -508 Pol.</li> <li>Aligned sensor size values to 1 decimal place.</li> </ul> </li> </ul> <p>Continued on next page.</p>

Table 2: Document history (sheet 1 of 13)

Version	Date	Remarks
V3.6.0	2024-Feb-19	<p>Continued from previous page.</p> <ul style="list-style-type: none"> <li>Reduced options for Temperature monitoring to “mainboard” only in <a href="#">Camera feature availability</a> on page 226.</li> <li>Added information on <a href="#">FPNC support</a> on page 289 and updated corresponding data in <a href="#">Camera feature availability</a> on page 226.</li> <li>Renamed chapter Frame rate jitter to <a href="#">Parameter changes</a> on page 291 and added contents for stopped streaming.</li> <li>Applied editorial changes.</li> </ul>
V3.5.1	2023-Dec-13	<p><b>Firmware version:</b> 00.13.00.e83c9689</p> <ul style="list-style-type: none"> <li>Updated firmware version to FW 00.13.00.e83c9689. FW 00.13.00.849ffda0 was never released.</li> <li>Added notes that bare board cameras must be aligned by the user in <a href="#">Specifications</a> on page 64 and in <a href="#">Installing the hardware</a> on page 251.</li> </ul>
V3.5.0	2023-Dec-04	<p><b>Release: Firmware version:</b> 00.13.00.e83c9689 FW 00.13.00.849ffda0 stated for this document version was never released.</p> <ul style="list-style-type: none"> <li>Updated table for <a href="#">Frame rates with rolling shutter sensors</a> on page 74.</li> <li>Extended information on <a href="#">Sensor binning</a> on page 75.</li> <li>Different from other Alvium series, frame rates in <a href="#">Specifications</a> on page 64 are calculated, not measured. The stated values are not affected by the change from FW V00.12 to FW V00.13.</li> <li>Added changes to <a href="#">Specifications</a> on page 64:           <ul style="list-style-type: none"> <li>Removed 1800 C-131 and -192 models, also from <a href="#">Lenses: Focal length vs. field of view</a> on page 229.</li> <li>Changed width resolution for 1800 C-510 and -511 from 2472 to 2464 pixels in <a href="#">Alvium 1800 C model specifications</a> on page 96. (The width resolution for these models is 2464 with all firmware versions. In earlier versions of this user guide, 2472 pixels were specified incorrectly.)</li> </ul> </li> </ul> <p>Continued on next page.</p>

Table 2: Document history (sheet 2 of 13)

Version	Date	Remarks
V3.5.0	2023-Dec-04	<p><b>Release: Firmware version:</b> 00.13.00.e83c9689</p> <p>Continued from previous page.</p> <ul style="list-style-type: none"> <li>Fixed errors with pixel formats in <a href="#">Alvium 1800 C model specifications</a> on page 96:               <ul style="list-style-type: none"> <li>Added support for sensor binning for 1800 C-158m, -203m, -240m, -291m, and -508m.</li> <li>Removed Packed pixel formats (only supported by Alvium G1 and G5).</li> <li>Corrected color pixel formats for 1800 C-500 from RG to GR.</li> <li>Separated Raw color pixel formats from RGB color pixel formats.</li> </ul> </li> <li>Added 8-bit readout for 1800 C-030 VSWIR in <a href="#">Alvium 1800 C model specifications</a> on page 96.</li> <li>Updated <a href="#">Camera feature availability</a> on page 226.</li> <li>Applied editorial changes.</li> </ul>
V3.4.3	2023-Nov-01	<p><b>Firmware version:</b> 00.12.00.00611a22</p> <p>Added contents to avoid permanent damage to the sensor by ESD:</p> <ul style="list-style-type: none"> <li>Extended the note for <a href="#">ESD</a> on page 57.</li> <li>Added <a href="#">Possible damage to image sensors due to electrostatic charge</a> on page 61.</li> <li>Added a warning in <a href="#">Sensor damage by ESD</a> on page 252 in the installation chapter.</li> </ul>
V3.4.2	2023-Oct-25	<p><b>Firmware version:</b> 00.12.00.00611a22</p> <p>Corrected frame rate values in the specs table for <a href="#">Alvium 1800 C-203m/c</a> on page 113.</p>
V3.4.1	2023-Oct-04	<p><b>Firmware version:</b> 00.12.00.00611a22</p> <p>Adjusted frame rate values for <a href="#">Alvium 1800 C-131m/c (coming soon)</a> on page 102.</p>

Table 2: Document history (sheet 3 of 13)

Version	Date	Remarks
V3.4.0	2023-Sep-27	<p><b>Firmware version:</b> 00.12.00.00611a22</p> <ul style="list-style-type: none"> <li>Added 1800 C-203 models in <a href="#">Specifications</a> on page 64 and in <a href="#">Lenses: Focal length vs. field of view</a> on page 229.</li> <li>Added 1800 C-131 and -192 models (coming soon) in <a href="#">Specifications</a> on page 64 and in <a href="#">Lenses: Focal length vs. field of view</a> on page 229.</li> <li>Added 12-bit pixel formats in <a href="#">Specifications</a> on page 64.</li> <li>Updated technical drawings for bare board and open housing cameras in <a href="#">Standard Alvium: Technical drawings</a> on page 208.</li> <li>Updated <a href="#">Cooling area for Alvium CSI-2 bare board cameras</a> on page 256.</li> <li>Updated <a href="#">Mounting area of Alvium CSI-2 bare board cameras connector side (left); sensor side (right)</a> on page 258.</li> <li>Applied editorial changes.</li> </ul>
V3.3.2	2023-Aug-08	<p><b>Firmware version:</b> 00.12.00.00611a22</p> <ul style="list-style-type: none"> <li>Updated references to coaxial cameras and connections by adding contents for STP. The Alvium FP3/GM2 Coax User Guide has been renamed to Alvium FP3/GM2 User Guide to include STP models.</li> <li>Changed status for Alvium Flex to available and updated product codes for Alvium Flex accessories in <a href="#">Alvium CSI-2 Flex</a> on page 19.</li> <li>Changed status for Alvium Frame to available in <a href="#">Alvium Frame - use your own optical mount</a> on page 21.</li> <li>Corrected values for length and mass for <a href="#">Alvium Frame: Dimensions and mass</a> on page 218 and <a href="#">Alvium Frame Flex: Dimensions and mass</a> on page 219.</li> <li>Added Global reset shutter (GRS) to 1800 C-1240 and -2050 for shutter type in <a href="#">Specifications</a> on page 64.</li> </ul>
V3.3.1	2023-Jul-05	<p><b>Firmware version:</b> 00.12.00.00611a22</p> <p>Changed horizontal resolution for 1800 C-510 and -511 in <a href="#">Specifications</a> on page 64.</p>

Table 2: Document history (sheet 4 of 13)

Version	Date	Remarks
V3.3.0	2023-Jun-14	<p><b>Firmware version:</b> 00.12.00.00611a22</p> <ul style="list-style-type: none"> <li>Added 1800 C-895m/c models in <a href="#">Specifications</a> on page 64 and in <a href="#">Lenses: Focal length vs. field of view</a> on page 229.</li> <li>Applied editorial changes.</li> </ul>
V3.2.0	2023-Jun-06	<p><b>Release: Firmware version:</b> 00.12.00.00611a22</p> <ul style="list-style-type: none"> <li>Added safety notes for handling sharp edges of Alvium Frame cameras in <a href="#">Read before use</a> on page 2, <a href="#">Handling lens mounts and Alvium Frame</a> on page 54, and <a href="#">Mounting Alvium Frame</a> on page 259.</li> <li>Updated specifications for Alvium 1800 C cameras for <b>GenICam for CSI-2 Access</b>.</li> <li>Updated maximum frame rates for <a href="#">Alvium 1800 C-1620m/c</a> on page 190 for a resolution of 5328 (H) × 3040 (V).</li> <li>Added data on sensor binning for selected models in <a href="#">Specifications</a> on page 64, in <a href="#">Camera feature availability</a> on page 226, and in <a href="#">Image data flow</a> on page 287.</li> <li>Updated <a href="#">Serial numbers of Alvium® chips and bare board cameras</a> on page 253.</li> </ul>
V3.1.1	2023-Apr-21	<p><b>Firmware version:</b> 00.11.00.9cf0c21e</p> <ul style="list-style-type: none"> <li>Added note about Alvium FP3/GM2 Coax cameras on the title page.</li> <li>Added reference to Alvium FP3/GM2 Coax cameras in <a href="#">Alvium CSI-2 cameras at a glance</a> on page 15.</li> </ul>
V3.1.0	2023-Mar-30	<p><b>Firmware version:</b> 00.11.00.9cf0c21e</p> <ul style="list-style-type: none"> <li>Added contents for Alvium CSI-2 Frame in:           <ul style="list-style-type: none"> <li><a href="#">Alvium CSI-2 cameras at a glance</a> on page 15</li> <li><a href="#">Specifications</a> on page 64</li> <li><a href="#">Mounting Alvium Frame</a> on page 259.</li> </ul> </li> <li>Updated contents for <b>Vimba X</b>.</li> <li>Updated QE curves for 1800 C-030 VSWIR and -130 VSWIR in <a href="#">Specifications</a> on page 64.</li> <li>Reduced value for sensor shift with 1800 C-2050 models to 150 µm in <a href="#">Sensor position accuracy</a> on page 222.</li> <li>Applied editorial changes.</li> </ul>

Table 2: Document history (sheet 5 of 13)

Version	Date	Remarks
V3.0.1	2023-Feb-28	<b>Firmware version:</b> 00.11.00.9cf0c21e <ul style="list-style-type: none"> <li>Applied editorial changes to remove ugly page breaks.</li> <li>Added index markers.</li> </ul>
V3.0.0	2023-Feb-21	<b>Firmware version:</b> 00.11.00.9cf0c21e <ul style="list-style-type: none"> <li>Updated Hebrew contents in <a href="#">Read before use</a> on page 2.</li> <li>Corrected the width value in the specifications for <a href="#">Alvium 1800 C-1620m/c</a> on page 190.</li> <li>Added contents for <a href="#">Alvium Flex - more flexibility</a> on page 19, in <a href="#">Specifications</a> on page 64, and in <a href="#">Camera interfaces</a> on page 266.</li> <li>Updated schematics in <a href="#">Table 100: Standard Alvium and Alvium Frame - Hirose FH55-22S-0.5SH connector pin assignment</a> on page 268.</li> <li>Updated <a href="#">Table 96: Bare Board (standard Alvium and Alvium Flex) model specific dimensions and nominal values</a> on page 209.</li> <li>Updated <a href="#">Cooling area for Alvium CSI-2 bare board cameras</a> on page 256.</li> <li>Updated contents in <a href="#">GenICam for CSI-2 Access - Camera operation</a> on page 250.</li> <li>Applied editorial changes.</li> </ul>
V2.9.1	2022-Nov-14	<b>Firmware version:</b> 00.11.00.9cf0c21e <ul style="list-style-type: none"> <li>Added note that lenses are not part of the product.</li> <li>Applied editorial changes.</li> </ul>
V2.9.0	2022-Oct-27	<b>Release: Firmware version:</b> 00.11.00.9cf0c21e <ul style="list-style-type: none"> <li>Updated standard references in <a href="#">Applied standards</a> on page 65.</li> <li>Updated ROI frame rates and exposure time ranges in <a href="#">Specifications</a> on page 64.</li> <li>Added note on deviations from stated frame rates in <a href="#">Achieved values deviating from specified values</a> on page 70.</li> <li>Updated various data for 1800 C-234m/c and -235m/c models in <a href="#">Specifications</a> on page 64.</li> <li>Added 1800 C-510m/c models in <a href="#">Specifications</a> on page 64 and in <a href="#">Lenses: Focal length vs. field of view</a> on page 229.</li> <li>Applied editorial changes.</li> </ul>

Table 2: Document history (sheet 6 of 13)

Version	Date	Remarks
V2.8.4	2022-Oct-19	<b>Firmware version:</b> 00.10.00.6c9062b1 <ul style="list-style-type: none"> <li>Added note to use Vimba 6.1 in <a href="#">Consider for Alvium CSI-2 cameras</a> on page 16.</li> <li>Updated ROI frame rates for 1800 C-234m/c and -235m/c models in <a href="#">Specifications</a> on page 64.</li> <li>Added <b>GenICam for CSI-2 Access</b> to Alvium 1800 C-234 and -235 models.</li> <li>Applied editorial changes.</li> </ul>
V2.8.3	2022-Sep-20	<b>Firmware version:</b> 00.10.00.6c9062b1 <ul style="list-style-type: none"> <li>Added Hebrew contents to <a href="#">Read before use</a> on page 2.</li> <li>Changed units Gbps to Gbit/s and KB to KByte for clarity.</li> <li>Corrected data in <a href="#">Specifications</a> on page 64:               <ul style="list-style-type: none"> <li>Max. gain for Alvium 1800 C-030 VSWIR and -130 VSWIR was changed to 42 dB.</li> <li>Pixel formats for Alvium 1800 C-234 and -235 were adjusted.</li> <li>Set all models to Available</li> <li>Removed FPNC availability for 1800 C-234 and -235.</li> </ul> </li> <li>Added a note in <a href="#">Image data flow</a> on page 287 that 1800 C-234 and -235 models currently do not support FPNC.</li> <li>Applied editorial changes.</li> </ul>
V2.8.2	2022-Aug-05	<b>Firmware version:</b> 00.10.00.6c9062b1 Removed “Coming soon” status for <a href="#">Alvium 1800 C-812 UV</a> on page 171.
V2.8.1	2022-Jul-22	<b>Firmware version:</b> 00.10.00.6c9062b1 <ul style="list-style-type: none"> <li>Added values for minimum and maximum exposure times in <a href="#">Specifications</a> on page 64.</li> <li>Corrected dimensions for screws from M2 to M1.6 in <a href="#">Mounting bare board cameras</a> on page 257.</li> </ul>

Table 2: Document history (sheet 7 of 13)



Version	Date	Remarks
V2.8.0	2022-Jul-20	<p><b>Release: Firmware version:</b> 00.10.00.6c9062b1</p> <ul style="list-style-type: none"> <li>Added <a href="#">Camera identification</a> on page 52, including Model ID for DoC assignment.</li> <li>Updated data in <a href="#">Specifications</a> on page 64:           <ul style="list-style-type: none"> <li>ROI frame rates and exposure time ranges</li> <li>Maximum gain for Sony IMX global shutter cameras increased to 48 dB.</li> </ul> </li> <li>Added 1800 C-234m/c, -235m/c, and -812 UV models in <a href="#">Specifications</a> on page 64 and in <a href="#">Lenses: Focal length vs. field of view</a> on page 229.</li> <li>Updated values for Exposure Modes of <a href="#">Alvium 1800 C-511m/c</a> on page 160.</li> <li>Added the information that Alvium 1800 C-511 is supplied on request only to <a href="#">Sensor position accuracy</a> on page 222.</li> <li>Added <a href="#">Camera feature availability</a> on page 226.</li> <li>Added warning against voltage levels of serial communication in <a href="#">Hirose FH55 connector pin assignment</a> on page 268.</li> <li>Added <a href="#">I/O use for UART</a> on page 273.</li> <li>Corrected pin assignment for non-isolated GND in Figure 103: <a href="#">GPIOs block diagram</a> on page 274.</li> <li>Removed FPNC support for VSWIR models and added DPC support for Alvium 1800 C-052 and -291 in <a href="#">Image data flow</a> on page 287.</li> <li>Removed the section “Control value changes on a streaming camera” from <a href="#">Performance</a> on page 290.</li> <li>Applied editorial changes.</li> </ul>
V2.7.1	2022-Apr-12	<p><b>Firmware version:</b> 00.08.00.6727174b</p> <ul style="list-style-type: none"> <li>Added notes that Alvium 1800 C-052 and -291 currently do not support DPC and FPNC to <a href="#">Image data flow</a> on page 287.</li> <li>Applied editorial changes.</li> </ul>

Table 2: Document history (sheet 8 of 13)

Version	Date	Remarks
V2.7.0	2022-Mar-17	<p><b>Release: Firmware version:</b> 00.08.00.6727174b</p> <ul style="list-style-type: none"> <li>Added contents for <b>GenICam for CSI-2 Access</b> at various places, including <a href="#">User sets</a> on page 225.</li> <li>Renamed Alvium 1800 C-030m <b>VSWIR</b> to Alvium 1800 C-030 <b>VSWIR</b>, and Alvium 1800 C-130m <b>VSWIR</b> correspondingly.</li> <li>Updated conditions for <a href="#">Operation for maximum frame rates</a> on page 73 and renamed <a href="#">Operation for medium power consumption</a> on page 75.</li> <li>Updated exposure time ranges by model in <a href="#">Specifications</a> on page 64.</li> <li>Added note about frame rates in triggered mode for <a href="#">Alvium 1500 C-120m/c</a> on page 80.</li> <li>Added Alvium 1800 C-052m/c, -291m/c, and -500m/c to <a href="#">Alvium 1800 C model specifications</a> on page 96.</li> <li>Added note for non-standard S-Mount hardware options in <a href="#">Sensor position accuracy</a> on page 222.</li> <li>Updated the flow chart and added descriptions for <b>GenICam for CSI-2 Access</b> in <a href="#">Access modes</a> on page 246.</li> <li>Added information on <a href="#">Ignored triggers</a> on page 281.</li> <li>Updated workflow in <a href="#">Image data flow</a> on page 287.</li> <li>Updated workflow in <a href="#">Value changes by control interdependencies</a> on page 292.</li> <li>Applied editorial changes.</li> </ul>
V2.6.2	2021-Dec-17	<p><b>Firmware version:</b> 00.07.00.81db3896</p> <ul style="list-style-type: none"> <li>Removed icon for compliance with UKCA in <a href="#">Compliance notifications</a> on page 52. (The icon was previously added by mistake.)</li> <li>Removed information on Digital Binning because it is not supported by the current camera driver.</li> </ul>
V2.6.1	2021-Nov-23	<p><b>Firmware version:</b> 00.07.00.81db3896</p> <ul style="list-style-type: none"> <li>Updated links to accessories.</li> <li>Applied minor editorial changes.</li> </ul>

Table 2: Document history (sheet 9 of 13)

Version	Date	Remarks
V2.6.0	2021-Nov-03	<p><b>Release: Firmware version:</b> 00.07.00.81db3896</p> <ul style="list-style-type: none"> <li>Added 1800 C-030m VSWIR and -130m VSWIR models in <a href="#">Specifications</a> on page 64 and in <a href="#">Lenses: Focal length vs. field of view</a> on page 229.</li> <li>Added <a href="#">Digital Binning</a> on page 50.</li> <li>Updated the minimum temperature value for operation and storage from +5 °C to -20 °C.</li> <li>Updated workflow in <a href="#">Image data flow</a> on page 287 for new Digital Binning.</li> <li>Updated diagram in <a href="#">Value changes by control interdependencies</a> on page 292.</li> <li>Removed Limitations for available resolutions from Troubleshooting.</li> <li>Applied minor editorial changes.</li> </ul>
V2.5.1	2021-Aug-12	<p><b>Firmware version:</b> 00.06.00.35992</p> <ul style="list-style-type: none"> <li>Added icon for compliance with UKCA in <a href="#">Compliance notifications</a> on page 52.</li> <li>Applied minor editorial changes.</li> </ul>
V2.5.0	2021-Aug-04	<p><b>Release: Firmware version:</b> 00.06.00.35992</p> <ul style="list-style-type: none"> <li>Added 1500 C-120 to <a href="#">Frame rate jitter</a> on page 291 and <a href="#">Trigger delay with 1500 C-120 cameras</a> on page 281.</li> <li>Added 1500 C-501m/c NIR model in <a href="#">Specifications</a> on page 64.</li> <li>Added 1800 C-511m/c, -811m/c, -1242m/c, -1620m/c, and -2040m/c models in <a href="#">Specifications</a> on page 64 and in <a href="#">Lenses: Focal length vs. field of view</a> on page 229.</li> <li>Updated tables with ROI frame rates, including bandwidth per lane in <a href="#">Specifications</a> on page 64.</li> <li>Reduced contents in <a href="#">Access modes</a> on page 246 (previous title: V4L2 controls vs. GenICam features).</li> <li>Applied minor editorial changes.</li> </ul>

Table 2: Document history (sheet 10 of 13)

Version	Date	Remarks
V2.4.0	2021-Apr-08	<p><b>Release: Firmware version:</b> 00.04.00.34658</p> <ul style="list-style-type: none"> <li>Added RAW pixel formats for 10-bit and 12-bit Mono in <a href="#">Specifications</a> on page 64.</li> <li>Added 1800 C-2460m/c models in <a href="#">Specifications</a> on page 64.</li> <li>Updated mass values in <a href="#">Standard Alvium: Dimensions and mass</a> on page 207.</li> <li>Updated descriptions in <a href="#">Access modes</a> on page 246.</li> <li>Updated instructions for <a href="#">Mounting the camera</a> on page 257.</li> <li>Updated graphic in <a href="#">Value changes by control interdependencies</a> on page 292.</li> <li>Applied minor editorial changes.</li> </ul>
V2.3.0	2020-Dec-15	<p><b>Release: Firmware version:</b> 00.03.00.31919</p> <ul style="list-style-type: none"> <li>Updated ROI frame rates and values for minimum and maximum exposure time in <a href="#">Specifications</a> on page 64.</li> <li>Added content about <a href="#">Pixel format default and naming</a> on page 69.</li> <li>Added values for <a href="#">White balance default</a> on page 206.</li> <li>Updated drawings and dimension values for bare board cameras in <a href="#">Standard Alvium: Technical drawings</a> on page 208.</li> <li>Updated tables in <a href="#">Access modes</a> on page 246.</li> <li>Added information about <a href="#">Serial numbers of Alvium® chips and bare board cameras</a> on page 253.</li> <li>Added <a href="#">Non-isolated, programmable GPIOs</a> on page 274.</li> <li>Added <a href="#">Triggering and timings</a> on page 277.</li> <li>In <a href="#">Image data flow</a> on page 287, added FPNC support for all models, except for Alvium 1800 C-2050.</li> <li>Added notes about frame rates for rolling shutter cameras run in triggered mode.</li> <li>Added content about <a href="#">Limitations for available resolutions</a> on page 201.</li> <li>Applied minor editorial changes.</li> </ul>

Table 2: Document history (sheet 11 of 13)

Version	Date	Remarks
V2.2.0	2020-Jul-22	<b>Release: Firmware version:</b> 00.02.00.29974 <ul style="list-style-type: none"> <li>Added Alvium 1800 C-240m/c, -508m/c, and -1240m/c models.</li> <li>Updated ROI frame rates and pixel formats in <a href="#">Specifications</a> on page 64.</li> <li>Updated Type for <a href="#">Alvium 1500 C-210m/c</a> on page 84.</li> <li>Added QE and spectral response to <a href="#">Alvium 1800 C-2050m/c</a> on page 198.</li> <li>Extended information in <a href="#">Shock and vibration</a> on page 65.</li> <li>Updated spectral response graphic in <a href="#">IR cut filter</a> on page 221.</li> <li>Added <a href="#">Sensor position accuracy</a> on page 222.</li> <li>Added <a href="#">Read before use</a> on page 2.</li> <li>Corrected minor errors.</li> </ul>
V2.1.3	2020-Mar-12	<b>Firmware version:</b> 00.01.03.29478 <ul style="list-style-type: none"> <li>Corrected maximum exposure times.</li> <li>DPC: Removed specifications into an application note.</li> <li>FPNC: Updated note in <a href="#">Image data flow</a> on page 287.</li> </ul>
V2.1.2	2020-Mar-04	<b>Firmware version:</b> 00.01.03.29478 Applied minor changes.
V2.1.1	2020-Feb-28	<b>Firmware version:</b> 00.01.03.29478 Updated content for shutter types.
V2.1.0	2020-Feb-20	<b>Release: Firmware version:</b> 00.01.03.29478 <ul style="list-style-type: none"> <li>Added Alvium 1800 C-319m/c, -507m/c, -1236m/c, and -2050m/c models.</li> <li>Added specifications for DPC.</li> <li>Updated description for sensor shutter types.</li> </ul>

Table 2: Document history (sheet 12 of 13)

Version	Date	Remarks
V2.0.0	2020-Jan-06	<b>Release: Firmware version:</b> 00.01.02.28100 <ul style="list-style-type: none"> <li>Added Alvium 1500 C-210m/c, 1800 C-040m/c, and -158m/c models.</li> <li>Added descriptions for Hue and Saturation in <a href="#">Access modes</a> on page 246.</li> <li>Added <a href="#">Dark current compensation</a> on page 293.</li> <li>Updated technical drawings and dimensions for bare board cameras in <a href="#">Standard Alvium: Dimensions and mass</a> on page 207.</li> <li>Updated values for power consumption in <a href="#">Specifications</a> on page 64.</li> <li>Restructured contents in <a href="#">Performance</a> on page 290.</li> </ul>
V1.1.0	2019-Jul-01	<b>Firmware version:</b> 00.01.00.26405 <ul style="list-style-type: none"> <li>Removed separate bit depth for maximum frame rates in <a href="#">Specifications</a> on page 64.</li> <li>Corrected ADC bit depth for Alvium 1500 C-500m/c in <a href="#">Specifications</a> on page 64 and for all models in <a href="#">Image data flow</a> on page 287.</li> </ul>
V1.0.0	2019-Jun-04	<b>Release: Firmware version:</b> 00.01.00.26405 Release version

Table 2: Document history (sheet 13 of 13)

## Conventions used in this user guide

To give this document an easily understood layout and to emphasize important information, the following typographical styles and symbols are used:

### Typographic styles

Style	Function
<b>Emphasis</b>	Programs or important things
Features and registers	Names for GenICam features or for camera control registers
<i>Feature and register options</i>	Options for GenICam features or for camera control registers
<i>Input commands</i>	Text or command to type in by the user, selectable options
<b>UIElements</b>	Text displayed or output by the system: GUI, dialog boxes, buttons, menus, important information, or windows titles
<a href="#">Web addresses and references</a>	Links to webpages and internal cross references

Table 3: Typographic styles

## Symbols and notes



### CAUTION

#### **Risk of burns**

Precautions are described



### CAUTION

#### **Injury by falling cameras or lenses**

Precautions are described



### CAUTION

#### **Risk of cuts by sharp edges**

Precautions are described



### NOTICE

#### **Material damage**

Precautions are described.



#### **Practical tip**

Additional information helps to understand or ease handling the camera.



#### **Avoiding malfunctions**

Precautions are described.



#### **Additional information**

Web address or reference to an external source with more information is shown.

## GenICam for CSI-2 Access

Selected Alvium 1800 C models support **GenICam for CSI-2 Access**, see [Access modes](#) on page 246. Data in this document applies to all Alvium CSI-2 cameras if not otherwise stated. Data applying to **GenICam for CSI-2 Access** is marked as follows:



### Paragraphs and graphics

A gray box with this icon signals that contents apply to **GenICam for CSI-2 Access** only.



### Specification headlines

This icon signals that camera models support **GenICam for CSI-2 Access** (in addition to the other access modes).

### Tables

**Red table border lines** signal that data applies to **GenICam for CSI-2 Access** only:

Feature	Specification
Feature 1	This specification applies to <b>all access modes</b> .
Feature 2	This specification applies to <b>GenICam for CSI-2 Access</b> only.

## Naming and terms

### Controls and features

Most functionalities for Alvium CSI-2 cameras are available as controls, using **Direct Register Access** or **Video4Linux Access**. Equivalent functionalities are available as features, using **GenICam for CSI-2 Access**, adding some more functionalities. **Gain Auto** in the Alvium CSI-2 Register Controls Reference equals **GainAuto** in the Alvium Features Reference.

In this user guide, data relating to features applies to the corresponding controls as well, unless otherwise stated. Therefore, the terms **Control** and **Feature** are used equivalently in this user guide.



## ROI and cropping

Cropping is a functionality similar to ROI (region of interest). By using a reduced area of the available sensor, the payload is reduced, increasing frame rates.

With **GenICam for CSI-2 Access**, features, such as **Width**, **Height**, **OffsetX**, and **OffsetY** are used, according to the GenICam SFNC (Standard Features Naming Convention).

With the **other Access modes**, the corresponding controls are used.



### Descriptions of controls and features

For the Alvium CSI-2 Register Controls Reference and the Alvium Features Reference, see [www.alliedvision.com/en/support/technical-documentation/alvium-csi-2-documentation](http://www.alliedvision.com/en/support/technical-documentation/alvium-csi-2-documentation).

## Camera model naming

Alvium cameras are named to identify model properties.

For example, **Alvium 1500 C-500c** is composed of:

	<b>Alvium</b>	<b>1500</b>	<b>C</b>	<b>500</b>	<b>c</b>
<b>Content element</b>	Camera series	Camera series detail	Interface	Resolution <sup>1</sup>	Color/monochrome
<b>Examples</b>	Alvium	1500: Basic feature set 1800: Advanced feature set or high-performance sensors	C: MIPI CSI-2 U: USB	500: 5.0 MP 050: 0.5 MP	c: color m: monochrome

<sup>1</sup>Model resolutions may slightly deviate from model naming.

Table 4: Camera model naming

## Terms and acronyms

<b>Term or acronym</b>	<b>Description</b>	<b>Reference</b>
adapter board	Printed circuit board (PCB) that connects embedded boards, cameras, and I/Os, dedicated to an individual embedded board	<a href="http://www.alliedvision.com/en/products/accessories">www.alliedvision.com/en/products/accessories</a>
bare board	Camera consisting of electronics and sensor on a common printed circuit board (PCB), to be designed into a housing with heat sink and lens mount	<a href="#">Bare Board (standard Alvium)</a> on page 208
CRA	Chief ray angle	<a href="#">Alvium 1800 C-508m/c</a> on page 149
EMVA	European Machine Vision Association	<a href="http://www.emva.org">www.emva.org</a>

Table 5: Terms and acronyms (sheet 1 of 2)

Term or acronym	Description	Reference
ERS	Electronic rolling shutter, see RS	<a href="#">Shutter types affecting image readout on page 296</a>
ESD	Electrostatic discharge	<a href="#">ESD on page 57</a>
FPC cable	(MIPI CSI-2 FPC cable) Flexible printed circuit cable, component that connects embedded boards and cameras via adapter board	<a href="http://www.alliedvision.com/en/products/accessories">www.alliedvision.com/en/products/accessories</a>
FPC connector	Hirose FH55-22S-0.5SH connector	<a href="http://www.hirose.com">www.hirose.com</a>
FPNC	Fixed pattern noise correction	<a href="#">Image data flow on page 287</a>
fps	Frames per second	<a href="#">Alvium 1800 C-508m/c on page 149</a>
GND	Ground (power)	<a href="#">Hirose FH55 connector pin assignment on page 268</a>
Gbit/s	Gigabit per second	<a href="#">Alvium 1800 C-508m/c on page 149</a>
GRRS	Global reset release shutter, see GRS	<a href="#">Shutter types affecting image readout on page 296</a>
GRS	Global reset shutter, see GRRS	<a href="#">Shutter types affecting image readout on page 296</a>
GS	Global shutter	<a href="#">Shutter types affecting image readout on page 296</a>
H × V	Horizontal × Vertical (sensor resolution)	<a href="#">Alvium 1800 C-508m/c on page 149</a>
KByte	Kilobyte	<a href="#">Alvium 1800 C-508m/c on page 149</a>
MP	Megapixels (see P)	<a href="#">Alvium 1800 C model specifications on page 96</a>
P	Pixels (see MP)	<a href="#">Alvium 1800 C model specifications on page 96</a>
PCB	Printed circuit board	<a href="#">Connecting FPC cable and FPC connectors on page 254</a>
PCBA	Printed circuit board assembly	<a href="#">PCBAs on page 57</a>
open housing	Camera housing that is open at the back side to be designed into an encompassing housing with other components	<a href="#">Open Housing C-Mount (standard Alvium) on page 210</a>
QE	Quantum efficiency	<a href="#">Absolute QE on page 78</a>
ROI	Region of interest	<a href="#">V4L2 controls and register controls on page 249</a>
RS	Rolling shutter, see ERS	<a href="#">Shutter types affecting image readout on page 296</a>
SFNC	Standard Features Naming Convention (GenICam)	<a href="http://www.emva.org">www.emva.org</a>
S-Mount	M12-Mount	<a href="#">Mounting and focusing S-Mount lenses on page 263</a>

Table 5: Terms and acronyms (sheet 2 of 2)

# Compliance, safety, and intended use



This chapter includes:

Camera identification.....	52
Compliance notifications .....	52
Intended use .....	53
Copyright and trademarks .....	54
Your safety.....	54
Product safety .....	56

## Camera identification

You can identify your Alvium CSI-2 camera like this:

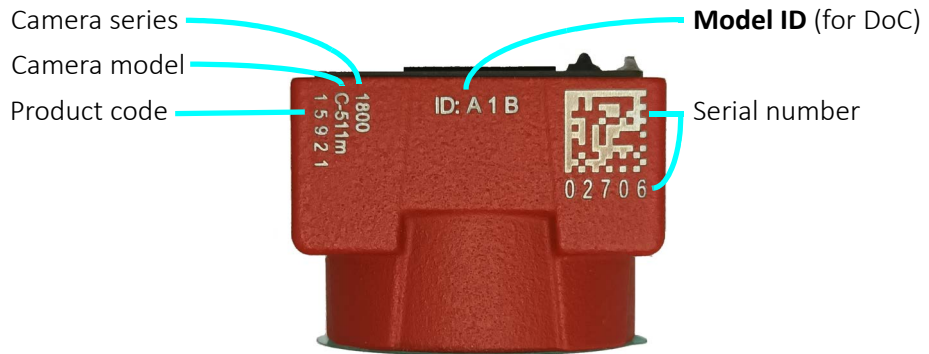

Figure 6: Hardware options and model IDs

Hardware option	Model ID
Open housing <b>standard Alvium CSI-2</b>	A 1 B
Open housing <b>Alvium CSI-2 Flex</b>	A 1 R
<b>Alvium CSI-2 Frame</b>	A 1 B
<b>Alvium CSI-2 Frame Flex</b>	A 1 R

Table 6: Hardware options and model IDs

Preparations to introduce Model IDs for Alvium **bare board cameras** are ongoing. Corresponding data will be added to a future version of this document.

## Compliance notifications



National regulations on disposal must be followed.

## Bare board and open housing cameras

Bare board and open housing cameras are designed for integration and are delivered without closed housing on customer's request. Housing design is critical for electromagnetic compatibility (EMC) of the camera.



### Requirements for EMC housings

See the Electromagnetic Compatibility for Open Housing Alvium Cameras application note at

[www.alliedvision.com/en/support/technical-documentation/alvium-csi-2-documentation](http://www.alliedvision.com/en/support/technical-documentation/alvium-csi-2-documentation).

## Avoid electromagnetic interferences

Interface cables, power cables, and I/O cables are sensitive to electromagnetic interference.

- Use shielded cables only.
- We recommend using cables offered by Allied Vision.
- Avoid coiling.
- We recommend using GPIOs only in environments with low electromagnetic interference.

Moreover, avoid unnecessary bending to prevent damaging the cables.

## Intended use

Allied Vision's objective is the development, design, production, maintenance, servicing and distribution of digital cameras and components for image processing. We are offering standard products as well as customized solutions.

Intended use of Allied Vision product is the integration into Vision systems by professionals. All Allied Vision product is sold in a B2B setting.

Allied Vision isn't a legal manufacturer of medical product. Instead, Allied Vision cameras and accessories may be used as components for medical product after design-in by the medical device manufacturer and based on a quality assurance agreement (QAA) between Allied Vision (supplier) and medical device manufacturer (customer). Allied Vision's duties in that respect are defined by ISO 13485, clause 7.2 (customer-related processes, equivalent to ISO 9001, clause 8.2).

## Copyright and trademarks

All text, pictures, and graphics are protected by copyright and other laws protecting intellectual property. All content is subject to change without notice.

All trademarks, logos, and brands cited in this document are property and/or copyright material of their respective owners. Use of these trademarks, logos, and brands does not imply endorsement.

Copyright © 2024 Allied Vision Technologies GmbH. All rights reserved.

## Your safety

This section informs about issues related to your personal safety. Descriptions explain how to avoid hazards and operate Alvium CSI-2 cameras safely.

### Handling lens mounts and Alvium Frame

The lens mount thread can have sharp edges. Be careful these edges do not cut your skin when mounting or unmounting lenses.

The circular front opening of Alvium Frame cameras has sharp edges.

- Avoid touching these edges with your fingers.
- Wear protective gloves for handling Alvium Frame cameras with an open circular front opening.

Follow the instructions in [Mounting Alvium Frame](#) on page 259.

### Housed cameras: handling hot cameras

If the mainboard temperature exceeds the specified maximum for more than two seconds, the camera is powered off automatically. The current value for mainboard temperature is output by `DeviceTemperature`, using Direct Register Access. You can use this value to control cooling by software, for example, to control a fan.

However, if you hold the camera in your hands during operation, your skin may get hurt. If you touch the camera when it is heated up, we recommend wearing protective gloves.

## Providing optimum heat dissipation

Design bare board and open housing cameras into a heat dissipative housing with a high thermal conductivity. For more information, see [Mounting bare board cameras](#) on page 257. Keep the operating temperature in the specified range to enable best image quality and to protect the camera from damage. Temperature values apply to a relative humidity of 0 to 80 percent that is non-condensing.

Hardware option	Housing	Components in the cooling area <sup>1</sup>	Mainboard <sup>2</sup>
Bare board <sup>3</sup>	Not applicable		See model
Open housing <sup>4</sup>	-20 °C to +65 °C	-20 °C to +85 °C	<a href="#">Specifications</a> on page 64.

<sup>1</sup>See [Mounting the heat sink](#) on page 256.

<sup>2</sup>Output by `DeviceTemperature`, using Direct Register Access.

<sup>3</sup>Ensure that the sensor is operated in the temperature range specified by the manufacturer. For any questions, please visit [www.alliedvision.com/en/support](http://www.alliedvision.com/en/support).

<sup>4</sup>Temperature values must be observed for the housing **and** for the cooling area.

*Table 7: Operating temperature ranges for Alvium CSI-2 cameras*

For your safety and to improve camera performance, operate the camera:

- Mounted to a base with a high thermal conductivity
- With lens or other optical components mounted
- With a heat sink mounted that has large surface areas (closed housing cameras include a heat sink)
- Using conductive media for camera and heat sink mounting
- With active cooling of camera, mounting base, and heat sink, such as by ventilation.
- Reduce high ambient temperature. For example, in outdoor applications with direct sunlight, provide shading by an enclosure.

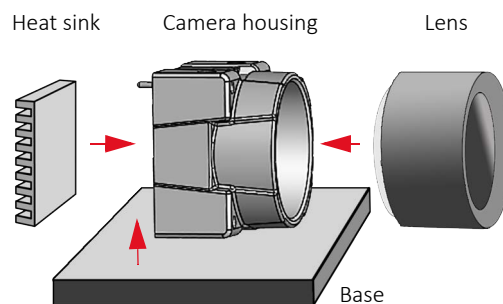

*Figure 7: Setup to provide optimum heat dissipation*



### More information

For more information on heat dissipation, see the [Optimum Heat Dissipation for Alvium Cameras](#) application note at [www.alliedvision.com/en/support/technical-documentation/alvium-csi-2-documentation](http://www.alliedvision.com/en/support/technical-documentation/alvium-csi-2-documentation).

## Camera mounting

Housed cameras must be mounted using the mounting threads. If vibration is higher than specified, cameras can disconnect from the mounting base. Falling cameras can hurt you. To avoid personal injury:

- Mount the camera according to the instructions in [Mounting open housing cameras](#) on page 258.
- Ensure, shock and vibration do not exceed the specified range, see [Shock and vibration](#) on page 65.
- Use a lens support if you want to use [Heavy lenses](#).

## Heavy lenses

- For non-static applications, use lenses with a mass less than 70 grams and a length less than 38 mm, where the center of gravity is 20 mm, measured from the lens mount front flange. For heavier or longer lenses, use a lens support and apply additional tests. For more information, please contact support at [www.alliedvision.com/en/about-us/contact-us/technical-support-repair/-/rma](http://www.alliedvision.com/en/about-us/contact-us/technical-support-repair/-/rma).

## Product safety

To prevent material damage, read the following and understand how to safely handle and operate the camera.

### Embedded systems

Setup and operation of Alvium CSI-2 cameras in embedded systems is different than for cameras in PC-based systems. Components can easily be damaged.

If you are unfamiliar with embedded systems, be extremely careful. Follow the instructions in [Installing the hardware](#) on page 251.

### Supported embedded boards

We have tested that Alvium CSI-2 cameras can be operated properly with the referenced embedded boards. For information on using these components safely, please see the documentation provided by the manufacturers of the embedded boards.



## Electrical connections

The MIPI CSI-2 standard does not specify electrical connections as extensively as the USB or GigE standard. Read specifications carefully.

Allied Vision accessories help to avoid damage to the camera and connected components. See [www.alliedvision.com/en/products/accessories](http://www.alliedvision.com/en/products/accessories) for suitable accessories. See [Specifications](#) on page 64 and [Installing the hardware](#) on page 251.

Alvium CSI-2 cameras are not protected against damage caused by reverse polarity.

- For specifications, see [Hirose FH55 connector pin assignment](#) on page 268.
- For instructions to avoid electronics damage, see [Connecting FPC cable and FPC connectors](#) on page 254.

## ESD

Follow these instructions to avoid damage to the camera, including possible **damage to the sensor**, see [Possible damage to image sensors due to electrostatic charge](#) on page 61.

ESD is dangerous for electronic devices, especially when tools or hands get in contact with connectors and electronic components. We recommend measures to avoid damage by ESD:

- Unpacking: Remove the camera from its anti-static packaging only when your body is grounded.
- Workplace: Use a static-safe workplace with static-dissipative mat and air ionization.
- Wrist strap: Wear a static-dissipative wrist strap to ground your body.
- Clothing: Wear ESD clothing. Keep components away from your body and clothing. Even if you are wearing a wrist strap, your body is grounded but your clothes are not.
- Housing: use an ESD housing, including the camera, embedded board, adapter board, and MIPI CSI-2 FPC cable.

## Cable connections

Provide sufficient strain relief for all cable connections to avoid short circuits and malfunctions.

## PCBAs

Alvium CSI-2 cameras enable access to PCBAs. Keep away from camera electronics to avoid damage.

## Camera power

Operating cameras beyond the specified range damages cameras. Cameras are powered using the Hirose FH55 connector for standard Alvium CSI-2 cameras and the Hirose DF40C-50DP-0.4V connector for Alvium CSI-2 Flex cameras at a maximum input of 5.5 VDC with minimum 1.5 A, using a limited power source (LPS), according to IEC 62368-1. The camera is not intended to be connected to a DC distribution network.

Only use power supplies that meet the insulation requirement according to PELV or SELV. For details, please refer to IEC 61140.

## Ground loops

Unsuitable connections can lead to different potentials between the camera system GND and the environmental shield/chassis GND caused by ground loops. This can damage the camera and the connected devices or cause malfunctions.

- Avoid potential differences between the camera housing and GND.
- All wiring must be done by authorized personnel, according to the corresponding technical standards.
- You may mount the camera electrically isolated.
- Read the Avoiding Ground Loops in Vision Systems application note.



### More information

See the Avoiding Ground Loops in Vision Systems application note at [www.alliedvision.com/en/support/technical-documentation/alvium-csi-2-documentation](http://www.alliedvision.com/en/support/technical-documentation/alvium-csi-2-documentation).

## Hirose FH55 and DF40C-50DP-0.4V connectors

Hirose FH55-22S-0.5SH FPC connectors and Hirose DF40C-50DP-0.4V board-to-board connectors enable compact camera design.

The small-sized connectors are sensitive to mechanical stress and are specified for maximum 20 mating and unmating cycles. Especially if you are inexperienced with these connectors, be very cautious. If these connectors are broken, cameras must be replaced. To install and operate cameras safely, read this section carefully.



### Additional information

For technical data and more instructions on the Hirose connectors, see the manufacturer data sheet at [www.hirose.com](http://www.hirose.com).

## Hirose FH 55 FPC connectors

Instructions in [Installing the hardware](#) on page 251 include helpful information to enable proper installation.

- Avoid stress to FPC connectors.
- Allow only the FPC cable to touch conductors.

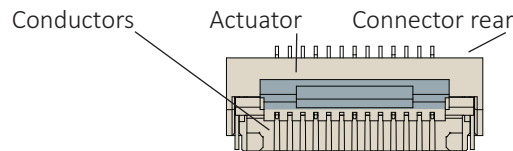

Figure 8: Hirose FH55-22S-0.5SH FPC connector

### Handling the actuator

- Move the actuator only between 0 degrees (locked position) and 105 degrees (open position).
- Carefully flip the actuator at the middle with your finger nail, see [Connecting FPC cable and FPC connectors](#) on page 254.

## MIPI CSI-2 FPC cables



### Manufacturing FPC cables or embedded boards

If you want to design your own components to connect Alvim CSI-2 cameras to embedded boards, contact your Allied Vision Sales representative or visit [www.alliedvision.com/en/about-us/contact-us/technical-support-repair/-/rma](http://www.alliedvision.com/en/about-us/contact-us/technical-support-repair/-/rma).

### FPC cable position

Short circuits of the FPC cable can damage the camera or connected hardware.

- Insert the FPC cable into the connector with cable guiding tabs matching the connector's side guides. See [Connecting FPC cable and FPC connectors](#) on page 254.
- Connect the camera and the embedded board (adapter) only as shown by the arrow printed on the FPC cable, see [Connecting FPC cable and FPC connectors](#) on page 254.

### FPC cables and stress

Over-stressed FPC cables can damage the camera and connected hardware. When camera and embedded board are twisted against each other or pulled apart from each other with too much force, the FPC cable is over-stressed. Spring contacts of FPC connectors are worn out, causing short circuits and unreliable electrical connections.

- Insert the FPC cable into the FPC connector at 12 degrees to the PCB board surface. See [Connecting FPC cable and FPC connectors](#) on page 254.
- Allow only slight bending of the FPC cable (minimum bending radius: 10 mm).
- Provide strain relief to avoid short cuts and malfunctions.

### No hot-plugging for MIPI CSI-2

Alvium CSI-2 cameras do not support hot-plugging. Hot-plugging can destroy the camera and connected hardware by high inrush current.

Disconnect power supplies before connecting FPC cables.

### FPC cable signal quality

Noise and electromagnetic interference can disable camera functions.

- Avoid contact to metal surfaces, causing electromagnetic interference.
- Please use cables recommended by Allied Vision.

## Handling bare board cameras

Bare board cameras are an electronic assembly without a protective housing. Therefore, they can easily be damaged.

- Handle bare board cameras with extreme care.
- Avoid any mechanical stress to the sensor area.
- Avoid short circuits by keeping away from electronics components.

Observe for mounting bare board cameras:

- Allow mechanical contact only at the mounting area. (This does not apply to the cooling area.)
- Enable proper cooling at the cooling area, see [Mounting bare board cameras](#) on page 257.
- Give 2 mm minimum clearance above board components.
- Tighten screws at 0.1 Nm maximum torque.
- Follow the instructions in [Mounting bare board cameras](#) on page 257.

## Optical components

Provide the following conditions to keep dirt and droplets out of the optical system of camera and lens:

- Dust-free environment
- Low relative humidity
- No condensation.

When camera or lens are stored:

- Cover the lens mount with a protection foil or cap.
- Cover front and back lens with caps.



### Damage to optical components by conductive media for heat sinks

See [Conductive media for heat sinks](#) on page 63 for details.

## Sensor

Sensors are sensitive to excessive radiation: focused sunlight, UV light, lasers, and X-rays can damage the sensor. Dirt and scratches can damage the sensor as well.

Alvium CSI-2 cameras do not need additional cleaning. Cameras are cleaned before shipping. Incorrect cleaning can damage the sensor or the filter. Therefore, never clean the sensor or the filter.

Protect the camera filter and the sensor from dirt, because dirt becomes more visible the closer it gets to the sensor. In addition, keep the back lens clean. Hold the camera with the lens mount facing the ground to keep dirt out of the lens mount. When no lens is mounted, protect the sensor and filter by a dust cap.

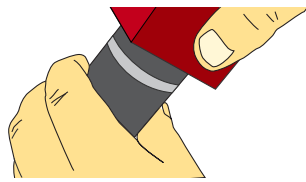

Figure 9: Holding the camera with the lens mount facing the ground

## Possible damage to image sensors due to electrostatic charge

Generally, bare board cameras and cameras with incomplete housings are very sensitive to electrostatic discharge (ESD) as electronics components are not protected.

In some rare cases, electrostatic charge occurring on the surface of the image sensor may cause damages to particular pixel groups, which may become visible as bubbles or blobs in the image generated by the sensor.

Therefore, it is very important to comply with ESD protection measures in accordance with technical standards.

Follow the instructions in [ESD](#) on page 57.

## Sensor cleanliness

Definitions for Alvium cameras are shown in [Table 8](#):

Sensor family	Aperture*	Visible particles quantity	Max. cluster size	Max. cluster quantity
			Pixels at f1/8.0	At f1/8.0
ON Semi	f1/4.0	0	30	2
Sony	f1/8.0	0	0	0

\* The incident beam (not related to the lens' angle of view) is  $\geq 7^\circ$  for f1/8.0 and  $\geq 14^\circ$  for f1/4.0.

Table 8: Sensor cleanliness definitions

Alvium cameras are manufactured to match the requirements of typical machine vision applications. This enables a clean image for typical monitor view. Particles may become visible when the image is viewed critically, such as with contrast enhancement or edge detection.



### Advanced sensor cleanliness

If standard definitions for Alvim do not fulfill the requirements of your application, please contact your Allied Vision Sales representative or visit [www.alliedvision.com/en/about-us/contact-us/technical-support-repair-/rma](http://www.alliedvision.com/en/about-us/contact-us/technical-support-repair-/rma).

## Lenses

### Maximum protrusion

The sensor, filter, lens, or camera electronics can be damaged if an object (typically a lens) exceeding maximum protrusion is mounted to the camera. Use lenses with a maximum protrusion within camera specifications. [Figure 10](#) shows maximum protrusion. For details, see [Maximum protrusion for front mounts](#) on page 220.

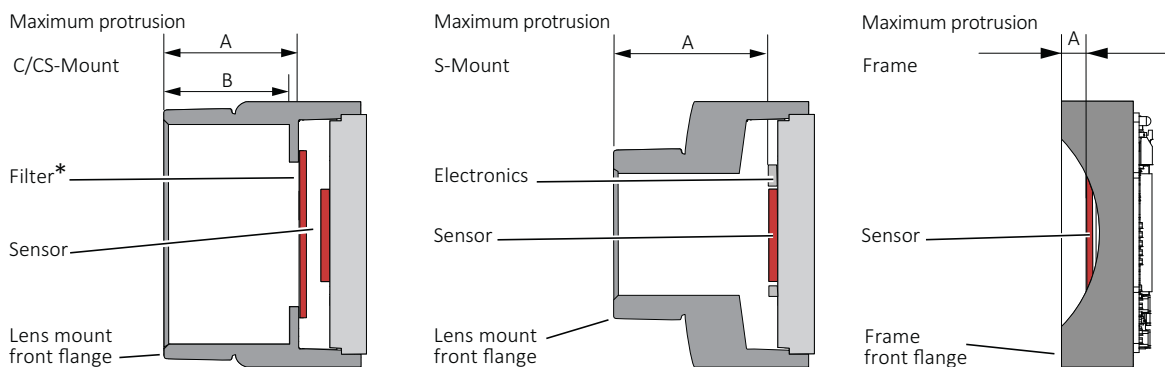

\*Only color models are equipped with an IR cut filter

Figure 10: Maximum protrusion CS-Mount and C-Mount, S-Mount, Frame

For S-Mount lenses, read [Mounting and focusing S-Mount lenses](#) on page 263 to avoid damage to the sensor, electronics, and lens.

## Mechanical components

### Heat sinks

Heat sinks can be used to cool the camera for safety and to improve image quality. Adhere to the instructions provided by the manufacturer of the heat sink.

## Conductive media for heat sinks

Some conductive media for heat sinks contain corrosive substances that can damage optical surfaces of the sensor, filter, and lens.

- Cover the optical path of the camera when you apply heat sink compound or adhesive to prevent substances and fumes from damaging optical surfaces.
- Adhere to the instructions and safety notes provided by the manufacturer of the conductive media.
- Ensure that the conductive media is correctly positioned: covering only the **cooling area**, see [Mounting the heat sink](#) on page 256.

# Specifications



This chapter includes:

Applied standards .....	65
Notes on specifications .....	68
Alvium 1500 C model specifications .....	76
Alvium 1800 C model specifications .....	96
White balance default .....	206
Standard Alvium: Dimensions and mass .....	207
Standard Alvium: Technical drawings .....	208
Alvium Flex: Dimensions and mass .....	207
Alvium Flex: Technical drawings .....	213
Alvium Frame: Dimensions and mass .....	218
Alvium Frame: Technical drawings .....	218
Alvium Frame Flex: Dimensions and mass .....	219
Alvium Frame Flex: Technical drawings .....	219
Maximum protrusion for front mounts .....	220
IR cut filter .....	221
Sensor position accuracy .....	222
User sets .....	225
Camera feature availability .....	226



## Applied standards



### GenICam

GenICam provides a generic access for cameras and devices that is independent of the interface. This enables operating cameras with USB3 Vision, GigE Vision, or CoaXPress interfaces with a common software. With the CSI-2 transport layer for Alvium, MIPI CSI-2 is added.

GenICam consists of multiple modules for different tasks. Allied Vision cameras and software use these modules, like the SFNC that standardizes feature names and types via an XML file or the transport layer interface (GenTL) used to grab images.

Selected Alvium 1800 C cameras comply to:

- GenICam Standard Document Version 2.1.1
- GenAPI Schema Version 1.1
- GenAPI Version 3.1
- GenICam Standard Features Naming Convention (SFNC) Version 2.7
- GenICam Pixel Format Naming Convention (PFNC) Version 2.2

### MIPI CSI-2

The MIPI (Mobile Industry Processor Interface) CSI (Camera Serial Interface)-2 standard describes a class of MIPI CSI-2 cameras for still image photography and video streaming. Generically, MIPI CSI-2 cameras are operated by Direct Register Access. Alvium CSI-2 cameras have a MIPI CSI-2 interface. They comply with:

- MIPI CSI-2 V1.1
- D-PHY V1.1.

### V4L2

The current V4L2 framework is described at [linuxtv.org](http://linuxtv.org). Allied Vision provides V4L2 drivers. You can download Allied Vision V4L2 drivers from [www.alliedvision.com/en/products/software/embedded-software-and-drivers](http://www.alliedvision.com/en/products/software/embedded-software-and-drivers).

### Shock and vibration

Alvium closed and open housing cameras were tested according to the following standards:

- IEC 60068-2-6, sinusoidal vibration testing
- IEC 60068-2-27, shock testing
- IEC 60068-2-64, random vibration testing.

Cameras were inspected before and after the tests. All tests were passed successfully:

Condition	Passed
Mechanics	<ul style="list-style-type: none"> <li>The camera housings showed no deformations.</li> <li>The connections between camera components had not come loose.</li> <li>The sensor position was within the specified tolerances of a new camera.</li> </ul>
Camera behavior	Camera functionalities were not affected, no deviations occurred.
Image streaming	Images were streamed without errors.

*Table 9: Conditions for passed tests*

The conditions for cameras and lenses were the same for all tests. Solid aluminum tubes were used to represent real lenses:

Parameter	Value
Lens dummy length	38 mm
Lens dummy mass	70 g
Center of gravity (CoG) <sup>1</sup>	20 mm

<sup>1</sup>For camera and lens dummy assemblies, measured from the lens mount front flange

*Table 10: Conditions for lenses*

## IEC 60068-2-6: Sinusoidal vibration

Frequency	Acceleration	Displacement
10 Hz to 58.1 Hz	Not applicable	1.5 mm
58.1 Hz to 500 Hz	20 g	Not applicable

*Table 11: Frequency, acceleration, and displacement for IEC 60068-2-6 tests*

Parameter	Value
Axis	x, y, z
Sweep rate	1 oct/min
Sweep duration per axis [hh:mm:ss]	00:11:17
Number of sweeps	20

*Table 12: Other parameters for IEC 60068-2-6 tests*

## IEC 60068-2-27: Shock

Parameter	Value
Axis	x, y, z
Acceleration	20 g
Number of shocks per axis	10
Duration per axis	11 ms
Waveform	Half sine

Table 13: Parameters for IEC 60068-2-27 tests

## IEC 60068-2-64: Random vibration

Frequency	Acceleration
15 Hz to 500 Hz	0.05 g <sup>2</sup> /Hz

Table 14: Frequency and acceleration for IEC 60068-2-64 tests

Parameter	Value
Axis	x, y, z
Acceleration RMS (Sigma)	4.9 g
Acceleration peak (Sigma)	14.8 g
Duration per axis [hh:mm:ss]	00:30:00

Table 15: Other parameters for IEC 60068-2-64 tests

# Notes on specifications

This section defines the conditions for specifications stated in this chapter.

## Sensor

### Absolute QE plots

Measurements for color cameras were done with IR cut filter, measurements for monochrome and S-Mount cameras were done without optical filters. With optical filters, QE decreases by approximately 10 percent. The uncertainty in measurement of the QE values is  $\pm 10$  percent. This is mainly due to uncertainties in the measuring apparatus itself (such as Ulbricht sphere and optometer).

Manufacturing tolerance of the sensor increases overall uncertainty.

### Sony sensors

Sony provides relative response curves in their sensor data sheets. To create the absolute QE plots shown in this chapter, the relative response was converted to a normalized QE response and then adjusted as per three measured QE values (at 448 nm, 529 nm, 632 nm) for color sensors and one measured QE value (at 529 nm) for monochrome sensors.

### ON Semiconductor sensors

The curve in the absolute QE plots shown in this chapter is from the sensor manufacturer data sheet. The information was correct at the time of publishing.

### Wavelength

The wavelength range in the absolute QE plots reflects the information available in the sensor manufacturer data sheet at the time of publishing. For additional wavelength information, contact the sensor manufacturer.

### Spectral response plots

The curves in the spectral response plots shown in this chapter were calculated from measured quantum efficiencies at 448 nm, 529 nm, and 632 nm. The shape of the curve is taken from the sensor data sheet but the values have been adjusted based on these measured values. The uncertainty in measurement of the spectral response values is  $\pm 10$  percent.

## Pixel format default and naming



### GenICam for CSI-2 Access

The **default pixel format** for Alvium CSI-2 cameras is RGB8 for color models and Mono8 for monochrome models.

**Pixel formats** are named according to the PFNC (Pixel Format Naming Convention), see [GenICam](#) on page 65.

### Other access modes

The **default pixel format** for Alvium CSI-2 cameras is RGB888 (RGB3). Monochrome cameras are included to enable quick access on V4L2 where V4L2\_PIX\_FMT\_UYVY is the default. For monochrome cameras, the 3 bytes for RGB are set to a common value, resulting in gray.

**Pixel formats** are named as extended MIPI CSI-2 definitions.

- [Video4Linux Access](#): According to V4L2 definitions.
- [Direct Register Access](#): Alvium CSI-2 cameras output pixel formats according to the MIPI CSI-2 standard.

Naming pattern	Examples
MIPI CSI-2 (FOURCC)	RAW8 (GREY) RGB888 (RGB3)

Table 16: Extended MIPI CSI-2 definitions for pixel format naming

**Media Bus Format** describes the string output by the Alvium MIPI CSI-2 driver to be received by the MIPI CSI-2 driver installed on the embedded board. Every Media Bus Format is assigned to a single MIPI CSI-2 pixel format.



#### More than one 4L2 format for a Media Bus Format

Sometimes, host drivers offer more than one V4L2 format for Media Bus Formats. Use `media-ctl -p command` to query which Media Bus Format (and the corresponding CSI format) is currently used by the host driver.

## Pixel formats for various standards

MIPI CSI-2	Media Bus Format	V4L2	V4L2 FOURCC	PFNC
YUV422 8-bit	MEDIA_BUS_FMT_UYVY8_2X8	V4L2_PIX_FMT_UYVY	UYVY	YCbCr422_8_CbYCrY
RGB888	MEDIA_BUS_FMT_RGB888_1X24	V4L2_PIX_FMT_RGB24	RGB3	RGB8

\* Depending a camera model and Bayer pattern

Table 17: Equivalent pixel formats in various standards (sheet 1 of 2) (sheet 1 of 2)

MIPI CSI-2	Media Bus Format	V4L2	V4L2 FOURCC	PFNC
RAW8	MEDIA_BUS_FMT_Y8_1X8	V4L2_PIX_FMT_GREY	GREY	Mono8
RAW8	MEDIA_BUS_FMT_SRGB8_1X8	V4L2_PIX_FMT_SRGB8	RGGB	BayerRG8*
RAW8	MEDIA_BUS_FMT_SGRGB8_1X8	V4L2_PIX_FMT_SGRBG8	GRBG	BayerGR8*
RAW8	MEDIA_BUS_FMT_SGBRG8_1X8	V4L2_PIX_FMT_SGBRG8	GBRG	BayerGB8*
RAW8	MEDIA_BUS_FMT_SBGGR8_1X8	V4L2_PIX_FMT_SBGGR8	BA81	BayerBG8*
RAW10	MEDIA_BUS_FMT_Y10_1X10	V4L2_PIX_FMT_Y10	Y10	Mono10
RAW10	MEDIA_BUS_FMT_SRGB10_1X10	V4L2_PIX_FMT_SRGB10	RG10	BayerRG10*
RAW10	MEDIA_BUS_FMT_SGRGB10_1X10	V4L2_PIX_FMT_SGRBG10	BA10	BayerGR10*
RAW10	MEDIA_BUS_FMT_SGBRG10_1X10	V4L2_PIX_FMT_SGBRG10	GB10	BayerGB10*
RAW10	MEDIA_BUS_FMT_SBGGR10_1X10	V4L2_PIX_FMT_SBGGR10	BG10	BayerBG10*
RAW12	MEDIA_BUS_FMT_Y12_1X12	V4L2_PIX_FMT_Y12	Y12	Mono12
RAW12	MEDIA_BUS_FMT_SRGB12_1X12	V4L2_PIX_FMT_SRGB12	RG12	BayerRG12*
RAW12	MEDIA_BUS_FMT_SGRGB12_1X12	V4L2_PIX_FMT_SGRBG12	BA12	BayerGR12*
RAW12	MEDIA_BUS_FMT_SGBRG12_1X12	V4L2_PIX_FMT_SGBRG12	GB12	BayerGB12*
RAW12	MEDIA_BUS_FMT_SBGGR12_1X12	V4L2_PIX_FMT_SBGGR12	BG12	BayerBG12*

\* Depending a camera model and Bayer pattern

Table 17: Equivalent pixel formats in various standards (sheet 2 of 2) (sheet 2 of 2)



#### Availability of pixel formats

The availability of pixel formats depends on camera models and the abilities of the connected system.

## Exposure time and frame rates

### Achieved values deviating from specified values

Values stated in the model specifications show the maximum available on an ideal system, supporting a bandwidth of 1.051 Gbit/s per lane. Your individual setup may affect available values such as for:

- Minimum and maximum exposure times and increments
- Maximum frame rates, including ROI frame rates
- Image resolution steps.
- **Image resolution steps.** Depending on the available increments, some standard resolutions are not supported. For example, instead of 1,440 × 900 pixels for WXGA+, 1,440 × 904 pixels are available.
- **Minimum resolution.** Depending on the embedded board, minimum resolution may be greater than stated in tables. For example, instead of 16 × 16 pixels, the minimum resolution available may be 256 × 32 pixels.

- We recommend you to set ROI values before you set values for Exposure Time, because interdependencies between controls affect each other. See [Value changes by control interdependencies](#) on page 292.
- **Deviations from stated frame rates** can occur, especially when:
  - The camera is operated in triggered mode
  - Low bandwidth is used
  - Small ROIs are used.

## CSI-2LaneCount and CSI-2ClockFrequency

Alvium cameras require higher bandwidths than supported by only one CSI-2 lane, especially with low CSI-2 clock frequencies. We recommend you to do extensive testing to find the best setup for maximum frame rates, regarding:

- CSI-2LaneCount
- CSI-2 ClockFrequency (CSI-2 Clock).

## Dropped frames or a viewer issue?

Alvium CSI-2 cameras are designed for a maximum bandwidth that does not exceed board abilities. However, if your setup does not provide sufficient bandwidth, frames are dropped. Even if bandwidth is sufficient, embedded boards may not be able to display all images of an image stream. In this case, only the display is affected but no dropped frames occur.

## Frame rates with ROI/Cropping

ROI and Cropping work similarly: While ROI is typically used for **GenICam for CSI-2 Access**, Cropping is typically used for the **other access modes**. By using a reduced area of the available sensor, the payload is reduced, increasing frame rates. This user guide uses the term ROI.

The maximum frame rate which can be achieved depends on various values, such as bandwidth, pixel format, exposure time, and ROI. Calculation of maximum frame rates for different ROIs for Alvium CSI-2 cameras does not allow to give a formula. Data is calculated for [Operation for maximum frame rates](#) on page 73.



### ROI frame rates and access modes with Alvium 1800 C

#### Values in this user guide refer to GenICam for CSI-2 Access

To achieve the stated ROI frame rates, `SensorBitDepth` with **GenICam for CSI-2 Access** is used to optimize the bandwidth usage when pixel formats have a lower bit depth than the native sensor ADC output.

Therefore, 1800 C models with `SensorBitDepth` support higher frame rates with **GenICam for CSI-2 Access** than with **Video4Linux Access** or **Direct Register Access**.

#### Values with other access modes

See the ROI Frame Rates with Video4Linux on Alvium 1800 C appendix document at [www.alliedvision.com/en/support/technical-documentation/alvium-csi-2-documentation](http://www.alliedvision.com/en/support/technical-documentation/alvium-csi-2-documentation).



### Sensor ADC readout modes for maximum frame rates

Selected Alvium CSI-2 camera models support various readout modes. This is stated in the tables for ROI frame rates.

If you are using pixel formats that do not require 12-bit sensor readout and you want to achieve higher frame rates, you can select between readout modes for 12-bit, 10-bit, and 8-bit with some Alvium CSI-2 camera models. See your model's specifications.

By default, Alvium 1800 CSI-2 models use the maximum (ADC) bit depth for `SensorBitDepth`. For selected models, *Adaptive* mode switches automatically between 12-bit and 10-bit sensor readout, depending on the bit depth of the selected pixel format. This allows to reduce bandwidth and increase frame rates when only 10-bit is required.

To enable the 8-bit sensor readout mode, you must switch manually, using `SensorBitDepth`. Please observe that the image brightness changes when you switch between 8-bit sensor readout mode and the other sensor readout modes.

Keep in mind that changing the output bit depth of the sensor also affects the minimum available exposure time of the camera.



#### Maximum frame rates at different values for `SensorBitDepth`

When the maximum bandwidth supported by CSI-2 interface is reached, reducing the value for `SensorBitDepth` does not increase the available maximum frame rate.



## Exposure time behavior regarding ExposureMode

This section informs about how exposure time behaves in the different exposure modes.

All Alviium cameras have an exposure time offset. The exposure time offset and the exposure time increment depend on sensor and camera characteristics. Both, the exposure time offset and the exposure time increment, can change if **Width**, **PixelFormat**, or values for **CSI-2LaneCount**, or **CSI-2 ClockFrequency** are changed. See [Value changes by control interdependencies](#) on page 292.

### ExposureMode = Timed

For all Alviium CSI-2 cameras, exposure time can be set by **ExposureTime** or **ExposureAuto**. For this, **ExposureMode** is set to *Timed*.

The selected exposure time is extended automatically:

- If the selected exposure time does not match the available increment, the camera automatically extends the exposure time to the next increment.
- The **exposure time offset is included** in the selected exposure time.



### ExposureMode = TriggerWidth or TriggerControlled

In addition, most global shutter (GS) cameras can control exposure time by the trigger signal, with the **ExposureMode** set to *TriggerWidth* or *TriggerControlled* (using *ExposureStart* and *ExposureStop*).

The trigger controlled exposure time is extended automatically:

- If the trigger controlled exposure time does not match the available increment, the camera automatically extends the exposure time to the next increment.
- Subsequently, the **exposure time offset is added**.

You can use *ExposureActive* to determine the duration of the exposure time offset.

## Operation for maximum frame rates

Values for maximum frame rates and for minimum and maximum exposure time in the specification tables are based on following parameters:

- Factory settings (camera after power up)
- Minimum exposure time
- Full resolution
- **GenICam for CSI-2 Access**
- Mono8 or Bayer8 pixel format
- Camera operation in freerun mode
- Without bandwidth limitations.

## Frame rates with rolling shutter sensors

The following table shows how the shutter type impacts available frame rates. Reducing the area for ROI reduces readout time. The relations in [Table 18](#) apply only if exposure time is shorter than readout time.

Sensor type	Shutter mode	Trigger mode	Frame rates at full resolution <sup>1</sup>	ROI frame rates
All models, except for...	Global shutter (GS)	Freerun	100%	Increased values
	Global shutter (GS)	External trigger	100%	
1500/1800 C-500, 1500 C-501 NIR	Rolling shutter (RS)	Freerun	100%	Increased values
	Rolling shutter (RS)	External trigger	>50%	
1800 C-1240	Rolling shutter (RS)	Freerun	100%	<b>No increase</b>
	Rolling shutter (RS)	External trigger	>99%	
	Global reset shutter (GRS)	Freerun	>99%	
	Global reset shutter (GRS)	External trigger	>99%	
1800 C-2050	Rolling shutter (RS)	Freerun	100%	Increased values
	Rolling shutter (RS)	External trigger	>99%	
	Global reset shutter (GRS)	Freerun	>99%	
	Global reset shutter (GRS)	External trigger	>99%	

<sup>1</sup> Related to the values for maximum frame rates stated in the specification tables for each model.  
Available with **GenICam for CSI-2 Access** only

Table 18: Frame rates depending on shutter types and trigger modes



### Delays

- For delays, see [Trigger latency](#) on page 279.
- Achieved frame rates may not match specified values:
  - Some sensors have an exposure start jitter that may reduce maximum frame rates.
  - Your individual setup may cause delays in data transmission.

## Brightness with 1800 C-812 UV cameras

When the sensor is exposed to light above 400 nm wavelength, the PLS (parasitic light sensitivity) effect occurs: The brightness level increases from the bottom to the top of the image.

## Sensor shutter types

Differences between global shutter (GS), rolling shutter (RS), and global reset shutter (GRS, **GenICam for CSI-2 Access** only) sensors are explained in [Shutter types affecting image readout](#) on page 296. Triggering behavior differs between cameras with global shutter (GS) and rolling shutter (RS). See [Triggering and timings](#) on page 277 for details.

## Digital binning

Selected Alvium 1800 C cameras combine digital horizontal binning and digital vertical binning for integer values 1 to 8. In GenICam for CSI-2 Access, horizontal and vertical binning values can be combined freely. In other access modes, horizontal and vertical values can be combined commonly only.



### **Alvium 1800 C models $\geq 12$ MP resolution**

If digital horizontal and digital vertical binning are set to 1 $\times$  and the digital vertical binning value is increased, digital horizontal binning is automatically set to 2 $\times$ .



## Sensor binning

Selected camera models support sensor binning in addition to digital binning. From these models, all support *Sum* for binning, some also support *Average*. See the specifications tables in [Alvium 1800 C model specifications](#) on page 96.



### **Please observe**

- Only digital binning or sensor binning can be used at a time.
- You must revert binning values to **1** before you can switch between these binning modes.

## Operation for medium power consumption

Values for power consumption in the specification tables are based on following parameters:

- Factory settings (camera after power up)
- Minimum exposure time
- Maximum frame rate
- Full resolution
- Pixel format (monochrome and color models)
  - **GenICam for CSI-2 Access:** Mono8 or Bayer8
  - **Other access modes:** RAW8 (GREY)
- Camera operation in freerun mode
- Without bandwidth limitations.

## Dimensions and mass

For your model's dimensions, see [Standard Alvium: Dimensions and mass](#) on page 207. In manufacturing, camera board and sensor are moved against each other to adjust flange focal distance. The value range for camera length with open housing cameras reflects in the technical drawings. See [Standard Alvium: Technical drawings](#) on page 208.

# Alvium 1500 C model specifications

## Alvium 1500 C-050m/c



### Supported firmware version

Alvium 1500 C-050 models are delivered with firmware 00.11.00.9cf0c21e. The firmware version cannot be updated to later versions.

Feature	Specification	
	1500 C-050m (monochrome)	1500 C-050c (color)
Sensor model	ON Semiconductor PYTHON 480	
Resolution	808 (H) × 608 (V); 0.5 MP	
Sensor type	CMOS	
Shutter type	Global shutter (GS)	
Sensor size	Type 1/3.6; 3.9 mm × 2.9 mm; 4.9 mm diagonal	
Pixel size	4.8 μm × 4.8 μm	
CRA	1.65 deg	
ADC bit depth	10-bit	
YUV color pixel formats	Not applicable	YUV422 8-bit (UYVY)
RGB color pixel formats	Default: RGB888 (RGB3)	
RAW pixel formats	RAW8 (GREY), RAW10 (Y10)	
Maximum frame rate	117 fps, using 1 to 4 lanes	
Exposure time	64 μs to 10 s (1 lane)	
Gain	0 dB to 11.3 dB; 0.1 dB increments	
Digital binning	Horizontal: 1 to 8 columns; Vertical: 1 to 8 rows	
Image buffer (RAM)	256 KByte	
Non-volatile memory (Flash)	1024 KByte	
GPIOs	2 programmable GPIOs As direct inputs (push-pull): 0 to 5.5 VDC As direct outputs (push-pull): 0 to 3.3 VDC at 12 mA	
Power requirements	Power over MIPI CSI-2	
Power consumption (typical, at 5 VDC)	1.3 W	
Storage temperature	-20 °C to +85 °C ambient temperature	

Table 19: Alvium 1500 C-050m/c specifications (sheet 1 of 2)

Feature	Specification			
	1500 C-050m/c			
Operating temperature	Hardware option	Housing	Cooling area <sup>1</sup>	Mainboard <sup>2</sup>
	Bare board <sup>3</sup>	Not applicable	-20 °C to +85 °C	-20 °C to +85 °C
	Open housing <sup>4</sup>	-20 °C to +65 °C		
Relative humidity	0% to 80% (non-condensing)			
Digital interface	MIPI CSI-2 D-PHY V1.1; 1, 2, or 4 lanes; maximum 1.051 Gbit/s per lane			
Camera controls	V4L2 controls (Video4Linux Access), Direct Register Access			

<sup>1</sup> See [Mounting the heat sink](#) on page 256.

<sup>2</sup> Output by `DeviceTemperature`

<sup>3</sup> Ensure that the sensor is operated in the temperature range specified by the manufacturer. For any questions, please visit [www.alliedvision.com/en/support](http://www.alliedvision.com/en/support).

<sup>4</sup> Temperature values must be observed for the housing **and** for the cooling area.

Table 19: Alvium 1500 C-050m/c specifications (sheet 2 of 2)

### Absolute QE

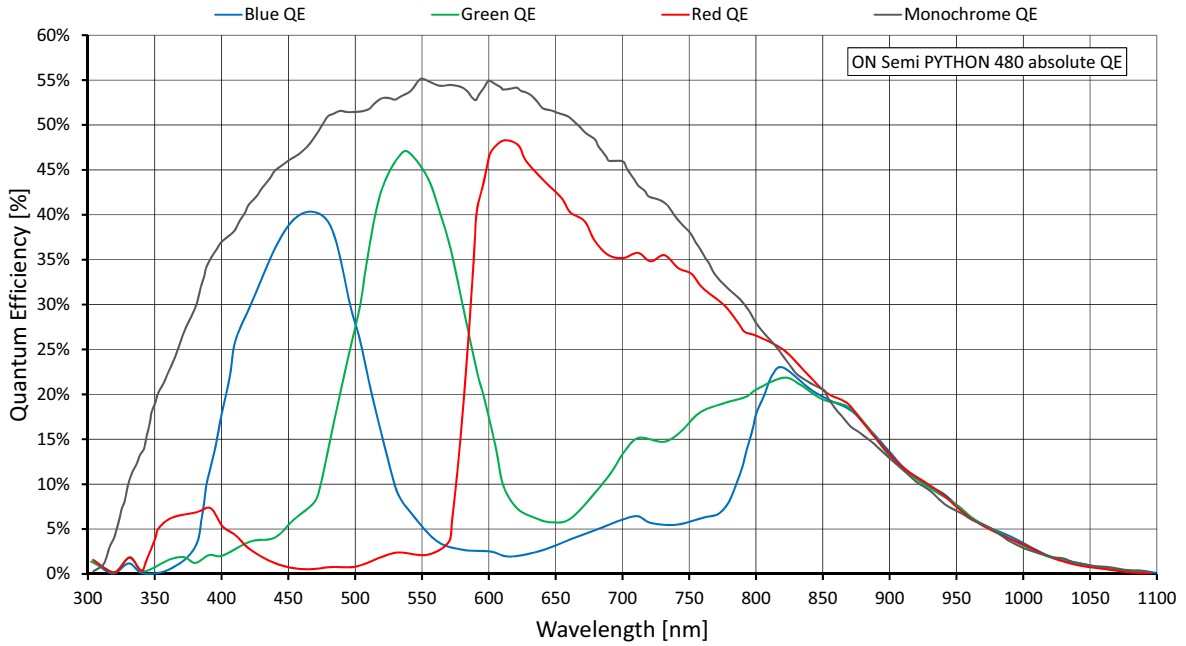

Figure 11: Alvium 1500 C-050m/c (ON Semi PYTHON 480) absolute QE

### Spectral response

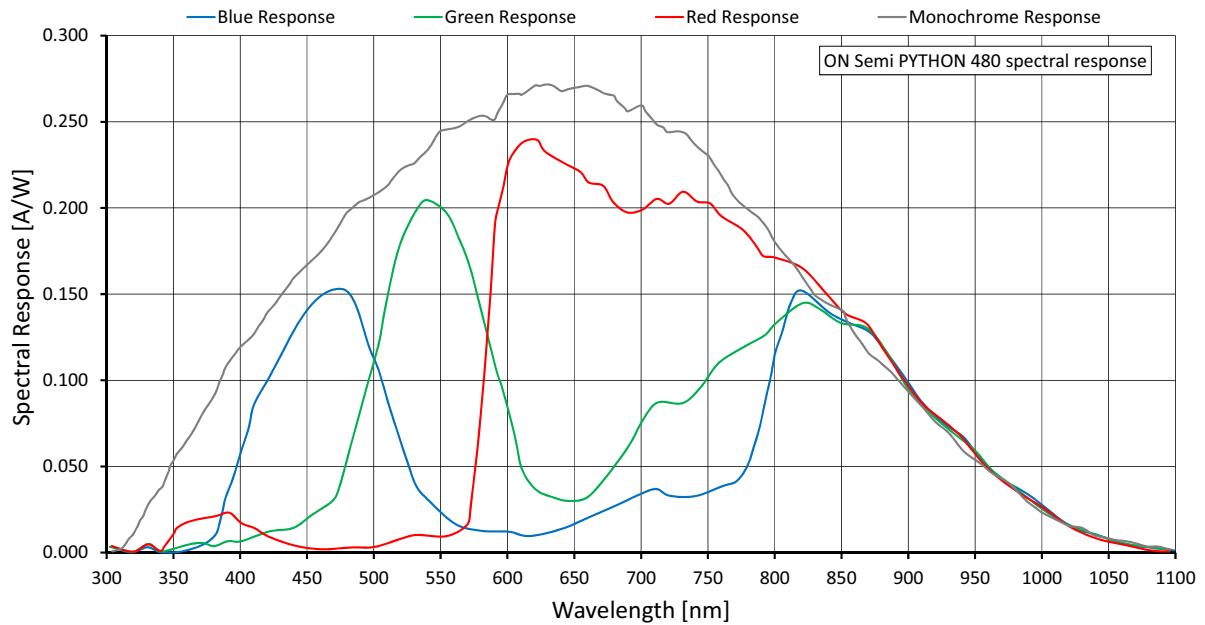

Figure 12: Alvium 1500 C-050m/c (ON Semi PYTHON 480) spectral response

## Frame rates with Cropping

Values were calculated as defined in [Frame rates with ROI/Cropping](#) on page 71 and in [Operation for maximum frame rates](#) on page 73.

Frame rates at maximum bandwidth calculates for 1.051 Gbit/s per lane. To reach the maximum frame rate available for typical operation, the bandwidth for image traffic is at 1 lane with 1.051 Gbit/s. Increasing the CSI-2 Lane Count value does not increase frame rates.

Image format	Width [pixels]	Height [pixels]	ROI area [MP]	Frame rate [fps] <sup>1</sup>		
				4-lane	2-lane	1-lane
				4.204 Gbit/s	2.102 Gbit/s	1.051 Gbit/s
Full resolution	808	608	0.491	117.1		
SVGA	800	600	0.480	119.5		
VGA	640	480	0.307	176.7		
HVGA	480	320	0.154	313.6		
QVGA	320	240	0.077	514.1		
HQVGA	240	160	0.038	784.8		
QQVGA	160	120	0.019	1069.7		
Max. × half	808	304	0.246	219.4		
Max. × min.	808	16	0.013	1278.2		
Min. × max.	16	608	0.010	726.5		
Min. × min.	16	16	256 P	1943.8		

<sup>1</sup> RAW8 (GREY) or RGB888 (RGB3) at 10-Bit readout

Table 20: Alvium 1500 C-050m/c ROI frame rates

## Alvium 1500 C-120m/c

Feature	Specification	
	1500 C-120m (monochrome)	1500 C-120c (color)
Sensor model	ON Semiconductor AR0135CS	
Resolution	1280 (H) × 960 (V); 1.2 MP	
Sensor type	CMOS	
Shutter type	Global shutter (GS)	
Sensor size	Type 1/3; 4.8 mm × 3.6 mm; 6.0 mm diagonal	
Pixel size	3.75 μm × 3.75 μm	
CRA	0 deg	
ADC bit depth	12-bit	
YUV color pixel formats	Not applicable	YUV422 8-bit (UYVY)
RGB color pixel formats	Default: RGB888 (RGB3)	
RAW pixel formats	RAW8 (GREY), RAW10 (Y10), RAW12 (Y12)	
Maximum frame rate	52 fps <sup>1</sup> , using 1 to 4 lanes	
Exposure time	57 μs to 8 s (1 lane)	
Gain	0 dB to 17.7 dB; 0.1 dB increments	
Digital binning	Horizontal: 1 to 8 columns; Vertical: 1 to 8 rows	
Image buffer (RAM)	256 KByte	
Non-volatile memory (Flash)	1024 KByte	
GPIOs	2 programmable GPIOs As direct inputs (push-pull): 0 to 5.5 VDC As direct outputs (push-pull): 0 to 3.3 VDC at 12 mA	
Power requirements	Power over MIPI CSI-2	
Power consumption (typical, at 5 VDC)	1.1 W	
Storage temperature	-20 °C to +85 °C ambient temperature	

<sup>1</sup> In triggered mode, maximum frame rates require minimum exposure times.

Table 21: Alvium 1500 C-120m/c specifications (sheet 1 of 2)



Feature	Specification			
	1500 C-120m/c			
Operating temperature	Hardware option	Housing	Cooling area <sup>2</sup>	Mainboard <sup>3</sup>
	Bare board <sup>4</sup>	Not applicable	-20 °C to +85 °C	-20 °C to +85 °C
	Open housing <sup>5</sup>	-20 °C to +65 °C		
Relative humidity	0% to 80% (non-condensing)			
Digital interface	MIPI CSI-2 D-PHY V1.1; 1, 2, or 4 lanes; maximum 1.051 Gbit/s per lane			
Camera controls	V4L2 controls (Video4Linux Access), Direct Register Access			
<sup>2</sup> See <a href="#">Mounting the heat sink</a> on page 256. <sup>3</sup> Output by <code>DeviceTemperature</code> <sup>4</sup> Ensure that the sensor is operated in the temperature range specified by the manufacturer. For any questions, please visit <a href="http://www.alliedvision.com/en/support">www.alliedvision.com/en/support</a> . <sup>5</sup> Temperature values must be observed for the housing <b>and</b> for the cooling area.				

Table 21: Alvium 1500 C-120m/c specifications (sheet 2 of 2)

### Absolute QE

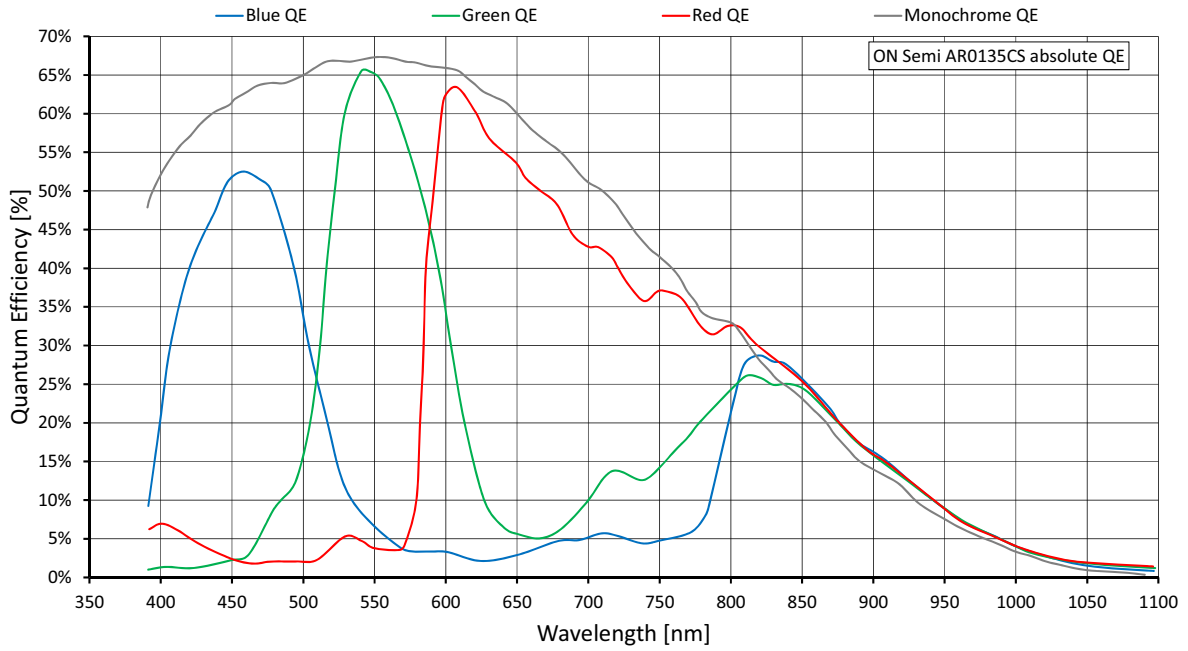

Figure 13: Alvium 1500 C-120m/c (ON Semi AR0135CS) absolute QE

### Spectral response

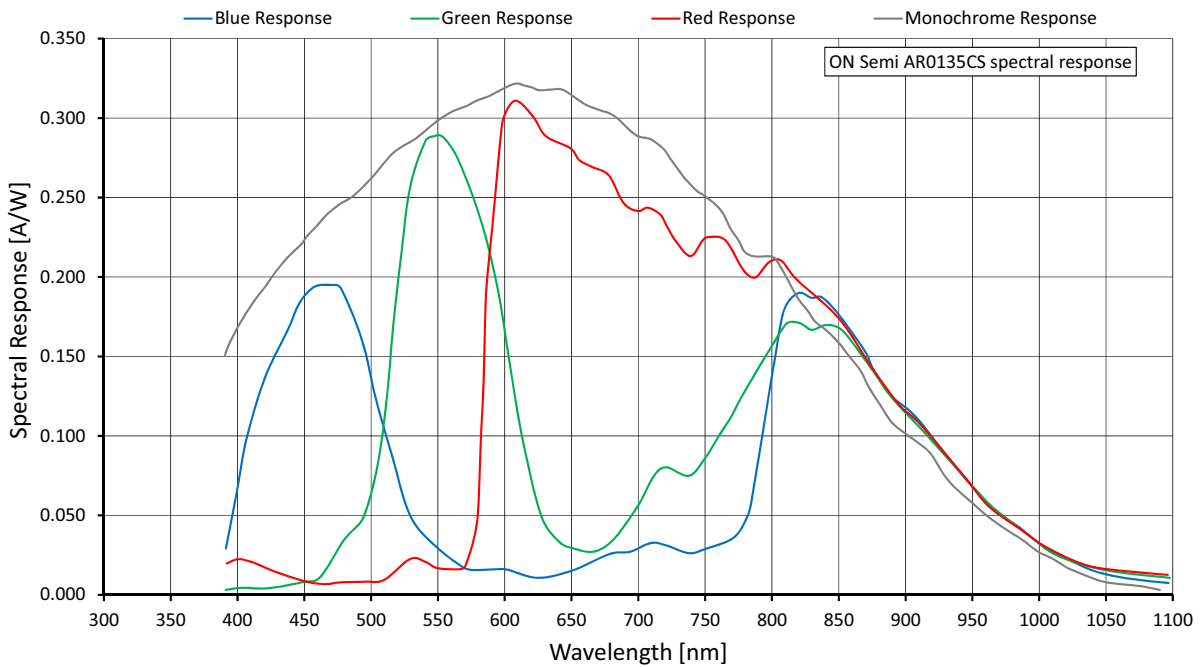

Figure 14: Alvium 1500 C-120m/c (ON Semi AR0135CS) spectral response

## Frame rates with Cropping

Values were calculated as defined in [Frame rates with ROI/Cropping](#) on page 71 and in [Operation for maximum frame rates](#) on page 73.

Frame rates at maximum bandwidth calculates for 1.051 Gbit/s per lane. To reach the maximum frame rate available for typical operation, the bandwidth for image traffic is at 1 lane with 1.051 Gbit/s. Increasing the CSI-2 Lane Count value does not increase frame rates.

Alvium 1500 C-120 cameras do not allow overlapping of exposure and readout.

**In triggered mode**, the maximum available frame rates may be reduced with long exposure times.

Image format	Width [pixels]	Height [pixels]	ROI area [MP]	Frame rate [fps] <sup>1</sup>		
				4-lane	2-lane	1-lane
				4.204 Gbit/s	2.102 Gbit/s	1.051 Gbit/s
Full resolution	1280	960	1.229	52.7		
HD 720	1280	720	0.922	69.1		
XGA	1024	768	0.786	65.1		
SVGA	800	600	0.480	81.9		
VGA	640	480	0.307	100.3		
HVGA	480	320	0.154	143.4		
QVGA	320	240	0.077	160.7		
HQVGA	240	160	0.038	160.8		
QQVGA	160	120	0.019	160.8		
Max. × half	1280	480	0.614	100.3		
Max. × min.	1280	16	0.020	160.4		
Min. × max.	16	960	0.015	52.8		
Min. × min.	16	16	256 P	160.8		

<sup>1</sup> RAW8 (GREY) or RGB888 (RGB3) at 12-Bit readout

Table 22: Alvium 1500 C-120m/c ROI frame rates

## Alvium 1500 C-210m/c

Feature	Specification	
	1500 C-210m (monochrome)	1500 C-210c (color)
Sensor model	ON Semiconductor AR0521SR	
Resolution	1928 (H) × 1088 (V); 2.1 MP	
Sensor type	CMOS	
Shutter type	Rolling shutter (RS)	
Sensor size	Type 1/3.6; 4.2 mm × 2.4 mm; 4.9 mm diagonal	
Pixel size	2.2 μm × 2.2 μm	
CRA	9 deg	
ADC bit depth	10-bit	
YUV color pixel formats	Not applicable	YUV422 8-bit (UYVY)
RGB color pixel formats	Default: RGB888 (RGB3)	
RAW pixel formats	RAW8 (GREY), RAW10 (Y10)	
Maximum frame rate	119 fps <sup>1</sup> , using 2 to 4 lanes	
Exposure time	8 μs to 10 s (2 lanes)	
Gain	0 dB to 24.1 dB; 0.1 dB increments	
Digital binning	Horizontal: 1 to 8 columns; Vertical: 1 to 8 rows	
Image buffer (RAM)	256 KByte	
Non-volatile memory (Flash)	1024 KByte	
GPIOs	2 programmable GPIOs As direct inputs (push-pull): 0 to 5.5 VDC As direct outputs (push-pull): 0 to 3.3 VDC at 12 mA	
Power requirements	Power over MIPI CSI-2	
Power consumption (typical, at 5 VDC)	1.9 W	
Storage temperature	-20 °C to +85 °C ambient temperature	
<sup>1</sup> In triggered mode: ~59 fps		

Table 23: Alvium 1500 C-210m/c specifications (sheet 1 of 2)

Feature	Specification			
	1500 C-210m/c			
Operating temperature	Hardware option	Housing	Cooling area <sup>2</sup>	Mainboard <sup>3</sup>
	Bare board <sup>4</sup>	Not applicable	-20 °C to +85 °C	-20 °C to +85 °C
	Open housing <sup>5</sup>	-20 °C to +65 °C		
Relative humidity	0% to 80% (non-condensing)			
Digital interface	MIPI CSI-2 D-PHY V1.1; 1, 2, or 4 lanes; maximum 1.051 Gbit/s per lane			
Camera controls	V4L2 controls (Video4Linux Access), Direct Register Access			
<sup>2</sup> See <a href="#">Mounting the heat sink</a> on page 256.				
<sup>3</sup> Output by <code>DeviceTemperature</code>				
<sup>4</sup> Ensure that the sensor is operated in the temperature range specified by the manufacturer. For any questions, please visit <a href="http://www.alliedvision.com/en/support">www.alliedvision.com/en/support</a> .				
<sup>5</sup> Temperature values must be observed for the housing <b>and</b> for the cooling area.				

Table 23: Alvium 1500 C-210m/c specifications (sheet 2 of 2)

### Absolute QE

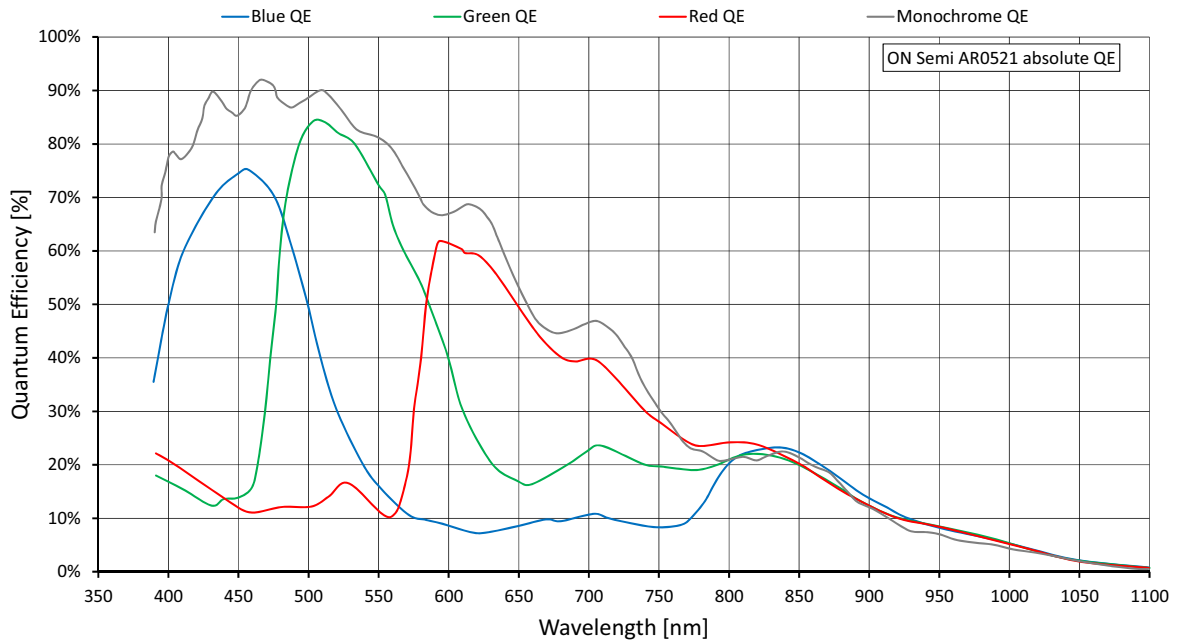

Figure 15: Alvium 1500 C-210m/c (ON Semi AR0521HD) absolute QE

### Spectral response

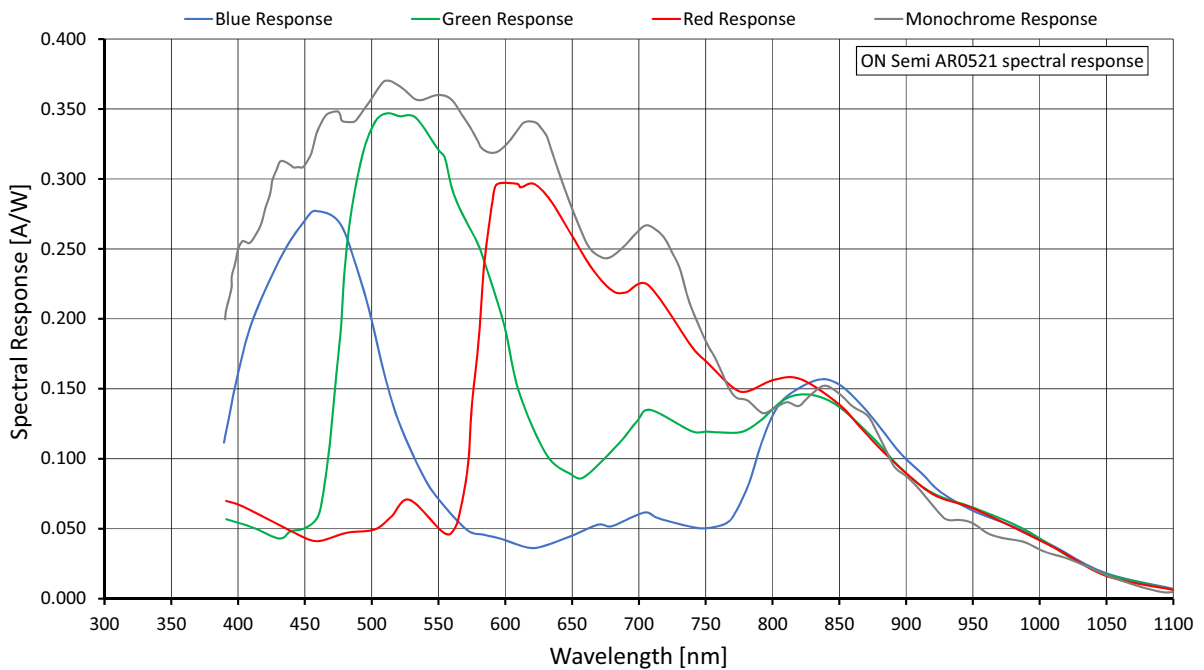

Figure 16: Alvium 1500 C-210m/c (ON Semi AR0521HD) spectral response

## Frame rates with Cropping

Values were calculated as defined in [Frame rates with ROI/Cropping](#) on page 71 and in [Operation for maximum frame rates](#) on page 73.

Frame rates at maximum bandwidth calculates for 1.051 Gbit/s per lane. To reach the maximum frame rate available for typical operation, the bandwidth for image traffic is at 2 lanes with 2.102 Gbit/s. Increasing the CSI-2 Lane Count value does not increase frame rates.

Shutter mode	User mode	Available frame rates
Rolling shutter (RS)	Freerun	Values in <a href="#">Table 25</a> below are reached.
Rolling shutter (RS)	Triggered	>50% of the values for in <a href="#">Table 25</a> below are reached.

Table 24: Frame rate behavior for different configurations

Image format	Width [pixels]	Height [pixels]	ROI area [MP]	Frame rate [fps] <sup>1</sup>		
				4-lane	2-lane	1-lane
				4.204 Gbit/s	2.102 Gbit/s	1.051 Gbit/s
Full resolution	1928	1088	2.098	119.6		60.2
Full HD	1920	1080	2.074	120.5		60.9
WXGA+ <sup>2</sup>	1440	904	1.302	143.2		96.3
SXGA	1280	1024	1.311	127.2		96.2
HD 720	1280	720	0.922	177.7		134.5
XGA	1024	768	0.786	167.7		158.1
SVGA	800	600	0.480		212.1	
VGA	640	480	0.307		261.3	
HVGA	480	320	0.154		378.2	
QVGA	320	240	0.077		488.0	
HQVGA	240	160	0.038		684.2	
QQVGA	160	120	0.019		856.3	
Max. × half	1928	544	1.049	229.2		116.0
Max. × min.	1928	16	0.031	2062.4		1154.5
Min. × max.	16	1088	0.017		120.8	
Min. × min.	16	16	256 P		2474.6	

<sup>1</sup> RAW8 (GREY) or RGB888 (RGB3) at 10-Bit readout

<sup>2</sup> Instead of 1,440 × 900

If resolutions were not available due to increments, frame rates relate to the next available resolution.

Table 25: Alvim 1500 C-210m/c ROI frame rates

## Alvium 1500 C-500m/c

Feature	Specification	
	1500 C-500m (monochrome)	1500 C-500c (color)
Sensor model	ON Semiconductor AR0521SR	
Resolution	2592 (H) × 1944 (V); 5.0 MP	
Sensor type	CMOS	
Shutter type	Rolling shutter (RS)	
Sensor size	Type 1/2.5; 5.7 mm × 4.3 mm; 7.1 mm diagonal	
Pixel size	2.2 μm × 2.2 μm	
CRA	9 deg	
ADC bit depth	10-bit	
YUV color pixel formats	Not applicable	YUV422 8-bit (UYVY)
RGB color pixel formats	Default: RGB888 (RGB3)	
RAW pixel formats	RAW8 (GREY), RAW10 (Y10)	
Maximum frame rate	68 fps <sup>1</sup> , using 4 lanes	
Exposure time	8 μs to 10 s (4 lanes)	
Gain	0 dB to 24.1 dB; 0.1 dB increments	
Digital binning	Horizontal: 1 to 8 columns; Vertical: 1 to 8 rows	
Image buffer (RAM)	256 KByte	
Non-volatile memory (Flash)	1024 KByte	
GPIOs	2 programmable GPIOs As direct inputs (push-pull): 0 to 5.5 VDC As direct outputs (push-pull): 0 to 3.3 VDC at 12 mA	
Power requirements	Power over MIPI CSI-2	
Power consumption (typical, at 5 VDC)	1.9 W	
Storage temperature	-20 °C to +85 °C ambient temperature	
<sup>1</sup> In triggered mode: ~34 fps		

Table 26: Alvium 1500 C-500m/c specifications (sheet 1 of 2)



Feature	Specification			
	1500 C-500m/c			
Operating temperature	Hardware option	Housing	Cooling area <sup>2</sup>	Mainboard <sup>3</sup>
	Bare board <sup>4</sup>	Not applicable	-20 °C to +85 °C	-20 °C to +85 °C
	Open housing <sup>5</sup>	-20 °C to +65 °C		
Relative humidity	0% to 80% (non-condensing)			
Digital interface	MIPI CSI-2 D-PHY V1.1; 1, 2, or 4 lanes; maximum 1.051 Gbit/s per lane			
Camera controls	V4L2 controls (Video4Linux Access), Direct Register Access			
<sup>2</sup> See <a href="#">Mounting the heat sink</a> on page 256. <sup>3</sup> Output by <code>DeviceTemperature</code> <sup>4</sup> Ensure that the sensor is operated in the temperature range specified by the manufacturer. For any questions, please visit <a href="http://www.alliedvision.com/en/support">www.alliedvision.com/en/support</a> . <sup>5</sup> Temperature values must be observed for the housing <b>and</b> for the cooling area.				

Table 26: Alvium 1500 C-500m/c specifications (sheet 2 of 2)

### Absolute QE

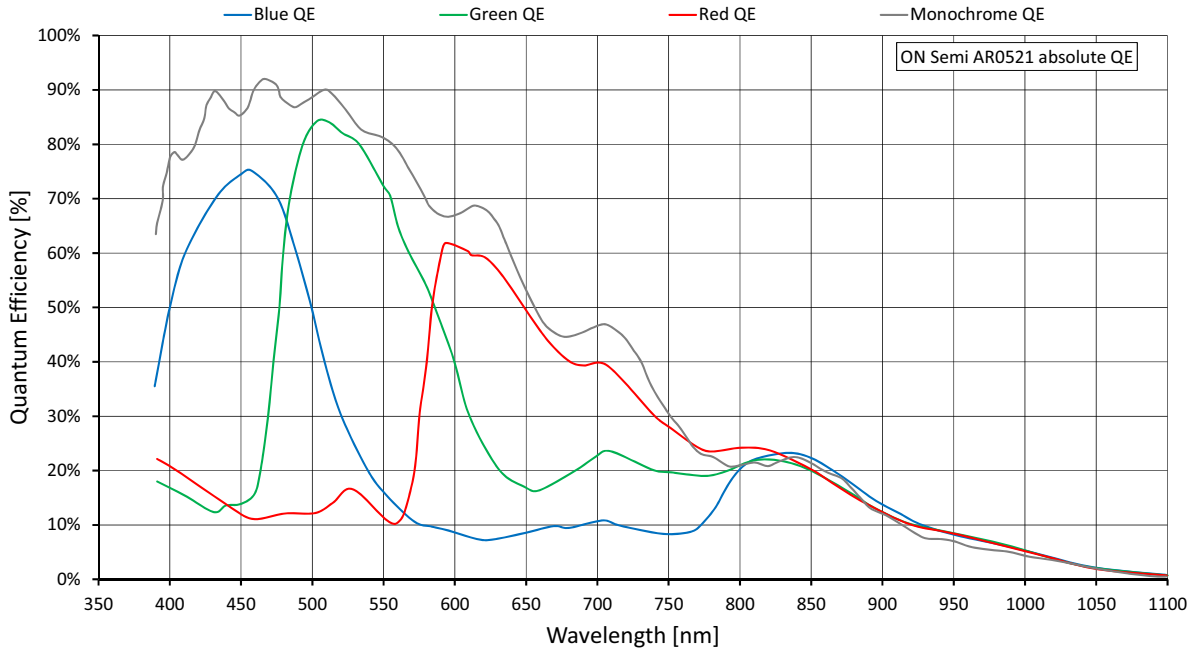

Figure 17: Alvium 1500 C-500m/c (ON Semi AR0521SR) absolute QE

### Spectral response

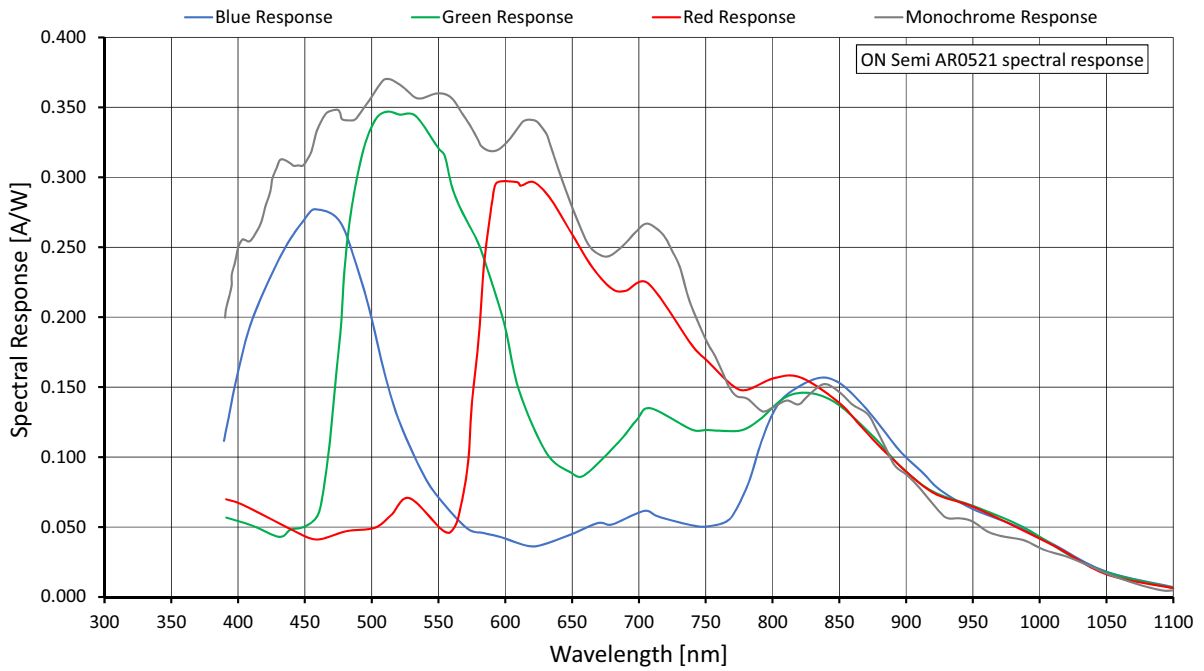

Figure 18: Alvium 1500 C-500m/c (ON Semi AR0521SR) spectral response

## Frame rates with Cropping

Values were calculated as defined in [Frame rates with ROI/Cropping](#) on page 71 and in [Operation for maximum frame rates](#) on page 73.

Frame rates at maximum bandwidth calculates for 1.051 Gbit/s per lane. To reach the maximum frame rate available for typical operation, the bandwidth for image traffic is at 4 lanes with 4.204 Gbit/s.

Shutter mode	User mode	Available frame rates
Rolling shutter (RS)	Freerun	Values in <a href="#">Table 28</a> below are reached.
Rolling shutter (RS)	Triggered	>50% of the values for in <a href="#">Table 28</a> below are reached.

Table 27: Frame rate behavior for different configurations

Image format	Width [pixels]	Height [pixels]	ROI area [MP]	Frame rate [fps] <sup>1</sup>		
				4-lane	2-lane	1-lane
				4.204 Gbit/s	2.102 Gbit/s	1.051 Gbit/s
Full resolution	2592	1944	5.039	68.1	50.8	25.5
WQHD	2560	1440	3.686	91.1	68.9	34.6
QXGA	2048	1536	3.146	85.8	80.8	40.6
Full HD	1920	1080	2.074	120.5		60.9
UXGA	1600	1200	1.920	109.1		66.0
WXGA+ <sup>2</sup>	1440	904	1.302	143.2		96.3
SXGA	1280	1024	1.311	127.2		96.2
HD 720	1280	720	0.922	177.7		134.5
XGA	1024	768	0.786	167.7		158.1
SVGA	800	600	0.480	212.1		
VGA	640	480	0.307	261.3		
HVGA	480	320	0.154	378.2		
QVGA	320	240	0.077	488.0		
HQVGA	240	160	0.038	684.2		
QQVGA	160	120	0.019	856.3		
Max. × half <sup>3</sup>	2592	976	2.530	132.0	98.8	49.7
Max. × min.	2592	16	0.041	1917.2	1535.3	858.9
Min. × max.	16	1944	0.031	68.6		
Min. × min.	16	16	256 P	2474.6		

<sup>1</sup> RAW8 (GREY) or RGB888 (RGB3) at 10-Bit readout

<sup>2</sup> Instead of 1,440 × 900 | <sup>3</sup> Instead of 2,592 × 972

If resolutions were not available due to increments, frame rates relate to the next available resolution.

Table 28: Alvium 1500 C-500m/c ROI frame rates

## Alvium 1500 C-501m/c NIR

Feature	Specification	
	1500 C-501m NIR (monochrome)	1500 C-501c NIR (color)
Sensor model	ON Semiconductor AR0522	
Resolution	2592 (H) × 1944 (V); 5.0 MP	
Sensor type	CMOS	
Shutter type	Rolling shutter (RS)	
Sensor size	Type 1/2.5; 5.7 mm × 4.3 mm; 7.1 mm diagonal	
Pixel size	2.2 μm × 2.2 μm	
CRA	9 deg	
ADC bit depth	10-bit	
YUV color pixel formats	Not applicable	YUV422 8-bit (UYVY)
RGB color pixel formats	Default: RGB888 (RGB3)	
RAW pixel formats	RAW8 (GREY), RAW10 (Y10)	
Maximum frame rate	68 fps <sup>1</sup> , using 4 lanes	
Exposure time	8 μs to 10 s (4 lanes)	
Gain	0 dB to 24.1 dB; 0.1 dB increments	
Digital binning	Horizontal: 1 to 8 columns; Vertical: 1 to 8 rows	
Image buffer (RAM)	256 KByte	
Non-volatile memory (Flash)	1024 KByte	
GPIOs	2 programmable GPIOs As direct inputs (push-pull): 0 to 5.5 VDC As direct outputs (push-pull): 0 to 3.3 VDC at 12 mA	
Power requirements	Power over MIPI CSI-2	
Power consumption (typical, at 5 VDC)	1.9 W	
Storage temperature	-20 °C to +85 °C ambient temperature	
<sup>1</sup> In triggered mode: ~34 fps		

Table 29: Alvium 1500 C-501m/c NIR specifications (sheet 1 of 2)

Feature	Specification			
	<b>1500 C-501m/c NIR</b>			
<b>Operating temperature</b>	<b>Hardware option</b>	<b>Housing</b>	<b>Cooling area<sup>2</sup></b>	<b>Mainboard<sup>3</sup></b>
	Bare board <sup>4</sup>	Not applicable	-20 °C to +85 °C	-20 °C to +85 °C
	Open housing <sup>5</sup>	-20 °C to +65 °C		
Relative humidity	0% to 80% (non-condensing)			
Digital interface	MIPI CSI-2 D-PHY V1.1; 1, 2, or 4 lanes; maximum 1.051 Gbit/s per lane			
Camera controls	V4L2 controls (Video4Linux Access), Direct Register Access			
<sup>2</sup> See <a href="#">Mounting the heat sink</a> on page 256. <sup>3</sup> Output by <code>DeviceTemperature</code> <sup>4</sup> Ensure that the sensor is operated in the temperature range specified by the manufacturer. For any questions, please visit <a href="http://www.alliedvision.com/en/support">www.alliedvision.com/en/support</a> . <sup>5</sup> Temperature values must be observed for the housing <b>and</b> for the cooling area.				

Table 29: Alvium 1500 C-501m/c NIR specifications (sheet 2 of 2)

### Absolute QE

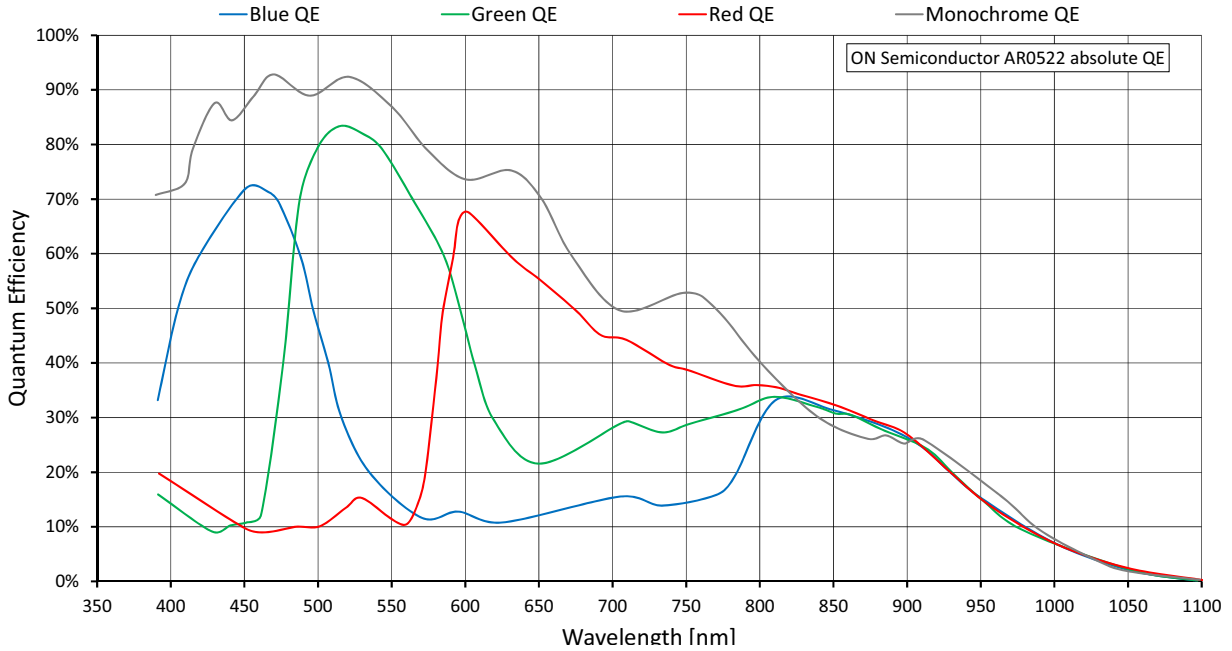

Figure 19: Alvium 1500 C-501m/c NIR (ON Semi AR0522) absolute QE

### Spectral response

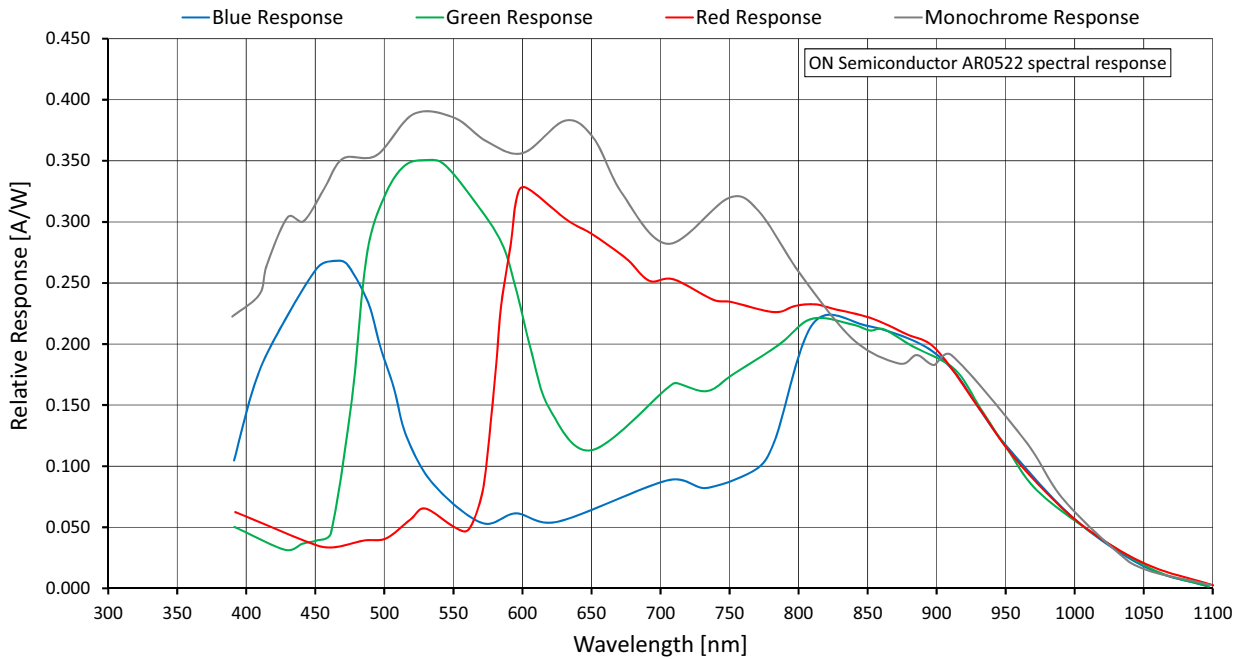

Figure 20: Alvium 1500 C-501m/c NIR (ON Semi AR0522) spectral response

## Frame rates with Cropping

Values were calculated as defined in [Frame rates with ROI/Cropping](#) on page 71 and in [Operation for maximum frame rates](#) on page 73.

Frame rates at maximum bandwidth calculates for 1.051 Gbit/s per lane. To reach the maximum frame rate available for typical operation, the bandwidth for image traffic is at 4 lanes with 4.204 Gbit/s.

Shutter mode	User mode	Available frame rates
Rolling shutter (RS)	Freerun	Values in <a href="#">Table 31</a> below are reached.
Rolling shutter (RS)	Triggered	>50% of the values for in <a href="#">Table 31</a> below are reached.

Table 30: Frame rate behavior for different configurations

Image format	Width [pixels]	Height [pixels]	ROI area [MP]	Frame rate [fps] <sup>1</sup>		
				4-lane	2-lane	1-lane
				4.204 Gbit/s	2.102 Gbit/s	1.051 Gbit/s
Full resolution	2592	1944	5.039	68.1	50.8	25.5
WQHD	2560	1440	3.686	91.1	68.9	34.6
QXGA	2048	1536	3.146	85.8	80.8	40.6
Full HD	1920	1080	2.074	120.5		60.9
UXGA	1600	1200	1.920	109.1		66.0
WXGA+ <sup>2</sup>	1440	904	1.302	143.2		96.3
SXGA	1280	1024	1.311	127.2		96.2
HD 720	1280	720	0.922	177.7		134.5
XGA	1024	768	0.786	167.7		158.1
SVGA	800	600	0.480	212.1		
VGA	640	480	0.307	261.3		
HVGA	480	320	0.154	378.2		
QVGA	320	240	0.077	488.0		
HQVGA	240	160	0.038	684.2		
QQVGA	160	120	0.019	856.3		
Max. × half <sup>3</sup>	2592	976	2.530	132.0	98.8	49.7
Max. × min.	2592	16	0.041	1917.2	1535.3	858.9
Min. × max.	16	1944	0.031	68.6		
Min. × min.	16	16	256 P	2474.6		

<sup>1</sup> RAW8 (GREY) or RGB888 (RGB3) at 10-Bit readout

<sup>2</sup> Instead of 1,440 × 900 | <sup>3</sup> Instead of 2,592 × 972

If resolutions were not available due to increments, frame rates relate to the next available resolution.

Table 31: Alvium 1500 C-501m/c NIR ROI frame rates

# Alvium 1800 C model specifications



## Alvium 1800 C-030 VSWIR

Red table border lines signal that **GenICam for CSI-2 Access** is required.

Feature	Specification
	<b>1800 C-030 VSWIR</b>
Sensor model	Sony IMX991
Resolution	656 (H) × 520 (V); 0.3 MP
Sensor type	InGaAs
Shutter type	Global shutter (GS)
Sensor size	Type 1/4; 3.3 mm × 2.6 mm; 4.1 mm diagonal
Pixel size	5 μm × 5 μm
CRA	0 deg
Sensor bit depth (ADC)	8-bit, 10-bit, 12-bit; Adaptive (10-bit, 12-bit)
Sensor bit depth (ADC)	12-bit
	<b>Pixel formats, GenICam for CSI-2 Access</b>
Monochrome pixel formats	Mono8 (default), Mono10, Mono10p, Mono12, Mono12p
	<b>Pixel formats, other access modes</b>
RAW pixel formats	RAW8 (GREY), RAW10 (Y10), RAW12 (Y12)
Maximum frame rate	249 fps, using 1 to 4 lanes
Maximum frame rate	132 fps, using 1 to 4 lanes
Exposure time	15 μs to 10 s (1 lane)
Exposure modes	Timed, TriggerControlled, TriggerWidth
Gain	0 dB to 42 dB; 0.1 dB increments
Digital binning	Horizontal: 1 to 8 columns; Vertical: 1 to 8 rows
Image buffer (RAM)	256 KByte
Non-volatile memory (Flash)	1024 KByte
GPIOs	2 programmable GPIOs As direct inputs (push-pull): 0 to 5.5 VDC As direct outputs (push-pull): 0 to 3.3 VDC at 12 mA
Power requirements	Power over MIPI CSI-2
Power consumption (typical, at 5 VDC)	1.8 W

Table 32: Alvium 1800 C-030 VSWIR specifications (sheet 1 of 2)



Feature	Specification			
	<b>1800 C-030 VSWIR</b>			
Storage temperature	-20 °C to +85 °C ambient temperature			
<b>Operating temperature</b>	<b>Hardware option</b>	<b>Housing</b>	<b>Cooling area<sup>1</sup></b>	<b>Mainboard<sup>2</sup></b>
	Bare board <sup>3</sup>	Not applicable	-20 °C to +85 °C	-20 °C to +85 °C
	Open housing <sup>4</sup>	-20 °C to +65 °C		
Relative humidity	0% to 80% (non-condensing)			
Digital interface	MIPI CSI-2 D-PHY V1.1; 1, 2, or 4 lanes; maximum 1.051 Gbit/s per lane			
Camera controls	GenICam (GenICam for CSI-2 Access)			
	V4L2 controls (Video4Linux Access), Direct Register Access			

<sup>1</sup> See [Mounting the heat sink](#) on page 256.

<sup>2</sup> Output by DeviceTemperature

<sup>3</sup> Ensure that the sensor is operated in the temperature range specified by the manufacturer. For any questions, please visit [www.alliedvision.com/en/support](http://www.alliedvision.com/en/support).

<sup>4</sup> Temperature values must be observed for the housing **and** for the cooling area.

Table 32: Alvim 1800 C-030 VSWIR specifications (sheet 2 of 2)

### Absolute QE

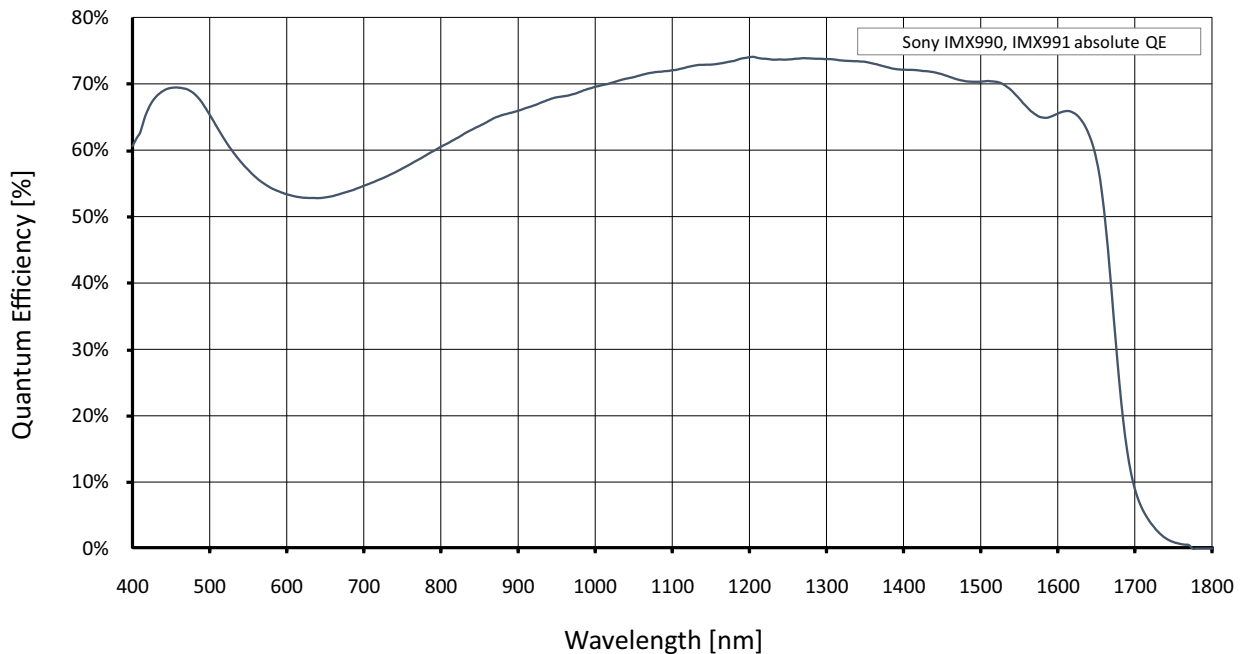

Figure 21: Alvim 1800 C-030 VSWIR (Sony IMX991) absolute QE

## Frame rates with Cropping

Values were calculated as defined in [Frame rates with ROI/Cropping](#) on page 71 and in [Operation for maximum frame rates](#) on page 73.

Frame rates at maximum bandwidth calculates for 1.051 Gbit/s per lane. To reach the maximum frame rate available for typical operation, the bandwidth for image traffic is at 1 lane with 1.051 Gbit/s. Increasing the CSI-2 Lane Count value does not increase frame rates.

Image format	Width [pixels]	Height [pixels]	ROI area [MP]	Frame rate [fps] <sup>1</sup>		
				4-lane	2-lane	1-lane
				4.204 Gbit/s	2.102 Gbit/s	1.051 Gbit/s
Full resolution	656	520	0.341	249.2 / 231.0 / 133.0		249.2 / 174.2 / 133.0
VGA	640	480	0.307	268.4 / 248.3 / 143.0		268.4 / 192.5 / 143.0
HVGA	480	320	0.154	384.9 / 356.4 / 205.2		
QVGA	320	240	0.077	494.1 / 457.2 / 262.7		
HQVGA	240	160	0.038	686.5 / 634.4 / 365.0		
QQVGA	160	120	0.019	849.9 / 789.2 / 454.6		
Max. × half <sup>3</sup>	656	264	0.173	450.4 / 416.9 / 241.0		450.4 / 315.4 / 241.0
Max. × min.	656	16	0.010	2069.4 / 1894.1 / 1133.1		2069.4 / 1465.7 / 1133.1
Min. × max.	16	520	0.008	252.3 / 234.3 / 134.1		
Min. × min.	16	16	256 P	2303.0 / 2138.5 / 1224.5		

<sup>1</sup> Mono8 at **SensorBitDepth** = 8-Bit<sup>(2)</sup> /  
 Mono10 at **SensorBitDepth** = 10-Bit  
 Mono12 at **SensorBitDepth** = 12-Bit

<sup>2</sup> The **SensorBitDepth** value must be set separately from **PixelFormat**.  
 See [Sensor ADC readout modes for maximum frame rates](#) on page 72 for details.

<sup>3</sup> Instead of 656 × 260  
 If resolutions were not available due to increments, frame rates relate to the next available resolution.

Table 33: Alvium 1800 C-030 VSWIR ROI frame rates



## Alvium 1800 C-040m/c

Red table border lines signal that **GenICam for CSI-2 Access** is required.

Feature	Specification	
	1800 C-040m (monochrome)	1800 C-040c (color)
Sensor model	Sony IMX287	
Resolution	728 (H) × 544 (V); 0.4 MP	
Sensor type	CMOS	
Shutter type	Global shutter (GS)	
Sensor size	Type 1/2.9; 5.0 mm × 3.8 mm; 6.3 mm diagonal	
Pixel size	6.9 μm × 6.9 μm	
CRA	0 deg	
Sensor bit depth (ADC)	8-bit, 10-bit, 12-bit; Adaptive (10-bit, 12-bit)	
Sensor bit depth (ADC)	12-bit	
<b>Pixel formats, GenICam for CSI-2 Access</b>		
Monochrome pixel formats	Mono8 (default), Mono10, Mono10p, Mono12, Mono12p	Mono8, Mono10, Mono10p, Mono12, Mono12p
YUV color pixel formats	Not applicable	YCbCr411_8_CbYYCrYY, YCbCr422_8_CbYCrY, YCbCr8_CbYCr
RGB color pixel formats	Not applicable	BGR8, RGB8 (default)
Raw color pixel formats	Not applicable	BayerRG8, BayerRG10, BayerRG10p, BayerRG12, BayerRG12p
<b>Pixel formats, other access modes</b>		
YUV color pixel formats	Not applicable	YUV422 8-bit (UYVY)
RGB color pixel formats	Default: RGB888 (RGB3)	
RAW pixel formats	RAW8 (GREY), RAW10 (Y10), RAW12 (Y12)	
Maximum frame rate	494 fps, using 2 to 4 lanes	
Maximum frame rate	289 fps, using 2 to 4 lanes	
Exposure time	20 μs to 10 s (2 lanes)	
Exposure modes	Timed, TriggerControlled, TriggerWidth	
Gain	0 dB to 48 dB; 0.1 dB increments	
Digital binning	Horizontal: 1 to 8 columns; Vertical: 1 to 8 rows	
Image buffer (RAM)	256 KByte	
Non-volatile memory (Flash)	1024 KByte	
GPIOs	2 programmable GPIOs As direct inputs (push-pull): 0 to 5.5 VDC As direct outputs (push-pull): 0 to 3.3 VDC at 12 mA	
Power requirements	Power over MIPI CSI-2	

Table 34: Alvium 1800 C-040m/c specifications (sheet 1 of 2)

Feature	Specification			
	<b>1800 C-040m/c</b>			
Power consumption (typical, at 5 VDC)	1.7 W			
Storage temperature	-20 °C to +85 °C ambient temperature			
<b>Operating temperature</b>	<b>Hardware option</b>	<b>Housing</b>	<b>Cooling area<sup>1</sup></b>	<b>Mainboard<sup>2</sup></b>
	Bare board <sup>3</sup>	Not applicable	-20 °C to +85 °C	-20 °C to +85 °C
	Open housing <sup>4</sup>	-20 °C to +65 °C		
Relative humidity	0% to 80% (non-condensing)			
Digital interface	MIPI CSI-2 D-PHY V1.1; 1, 2, or 4 lanes; maximum 1.051 Gbit/s per lane			
Camera controls	GenICam (GenICam for CSI-2 Access) V4L2 controls (Video4Linux Access), Direct Register Access			
<sup>1</sup> See <a href="#">Mounting the heat sink</a> on page 256. <sup>2</sup> Output by <code>DeviceTemperature</code> <sup>3</sup> Ensure that the sensor is operated in the temperature range specified by the manufacturer. For any questions, please visit <a href="http://www.alliedvision.com/en/support">www.alliedvision.com/en/support</a> . <sup>4</sup> Temperature values must be observed for the housing <b>and</b> for the cooling area.				

Table 34: Alvium 1800 C-040m/c specifications (sheet 2 of 2)

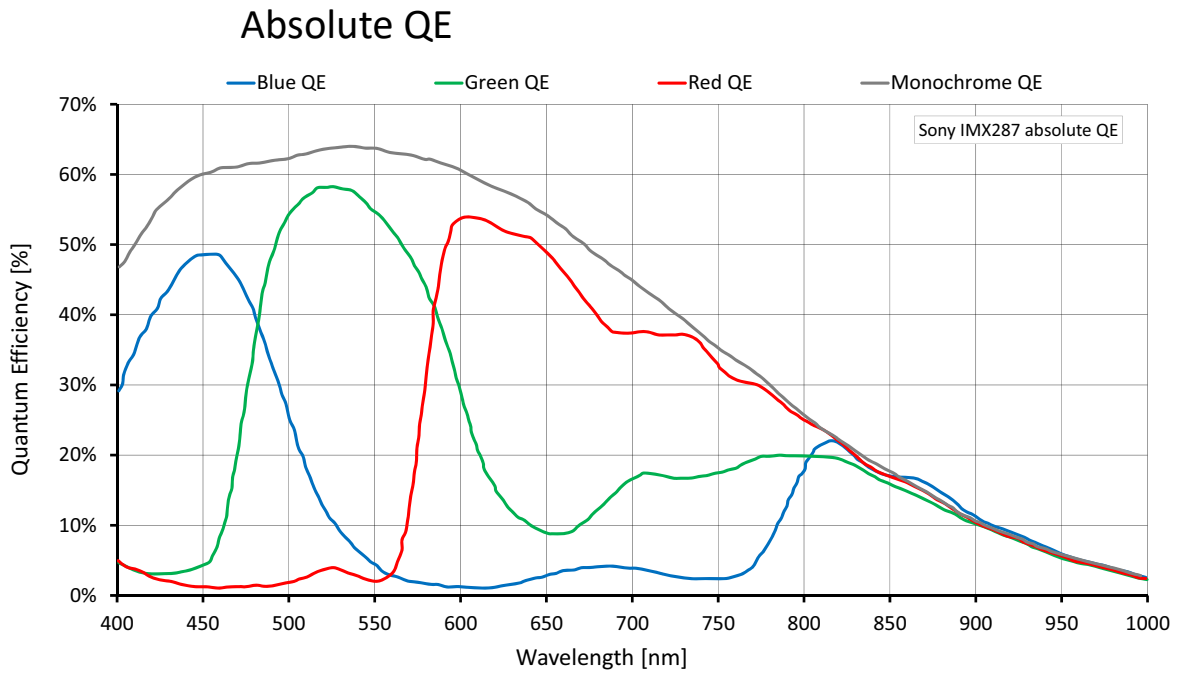

Figure 22: Alvium 1800 C-040m/c (Sony IMX287) absolute QE

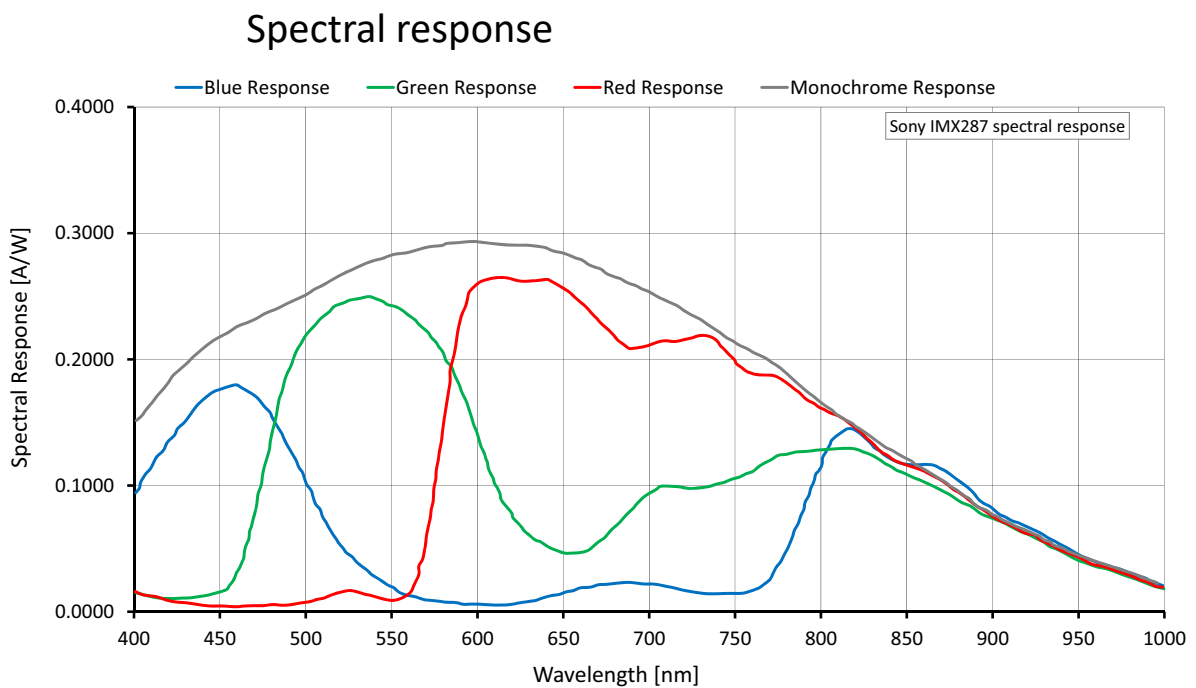

Figure 23: Alvium 1800 C-040m/c (Sony IMX287) spectral response

## Frame rates with Cropping

Values were calculated as defined in [Frame rates with ROI/Cropping](#) on page 71 and in [Operation for maximum frame rates](#) on page 73.

Frame rates at maximum bandwidth calculates for 1.051 Gbit/s per lane. To reach the maximum frame rate available for typical operation, the bandwidth for image traffic is at 2 lanes with 2.102 Gbit/s. Increasing the CSI-2 Lane Count value does not increase frame rates.

Image format	Width [pixels]	Height [pixels]	ROI area [MP]	Frame rate [fps] <sup>1</sup>		
				4-lane	2-lane	1-lane
				4.204 Gbit/s	2.102 Gbit/s	1.051 Gbit/s
Full resolution	728	544	0.396	494.8 / 409.3 / 302.3	494.8 / 294.3 / 294.0	297.9 / 149.5 / 148.7
VGA	640	480	0.307	554.3 / 458.5 / 338.9	554.3 / 373.9 / 338.9	376.4 / 190.4 / 189.8
HVGA	480	320	0.154	786.3 / 653.8 / 483.5		662.2 / 360.4 / 358.8
QVGA	320	240	0.077	991.2 / 833.4 / 617.7		836.5 / 682.6 / 617.7
HQVGA	240	160	0.038	1340.5 / 1144.1 / 847.2		1135.2 / 1144.1 / 847.2
QQVGA	160	120	0.019	1627.3 / 1398.3 / 1037.7		1382.0 / 1398.3 / 1037.7
Max. × half	728	272	0.198	887.2 / 733.8 / 544.8	887.2 / 532.5 / 530.6	541.2 / 272.7 / 270.9
Max. × min.	728	16	0.012	3497.7 / 2893.0 / 2225.3	3497.7 / 2236.4 / 2187.2	2340.5 / 1216.2 / 1195.7
Min. × max.	16	544	0.009	498.0 / 416.7 / 306.8		418.2 / 416.7 / 306.8
Min. × min.	16	16	256 P	3666.3 / 3311.8 / 2496.0		3178.5 / 3311.8 / 2496.0

<sup>1</sup> Mono8 or Bayer...8<sup>(2)</sup> at SensorBitDepth = 8-Bit<sup>(3)</sup> /  
 Mono10 or Bayer...10 at SensorBitDepth = 10-Bit  
 Mono12 or Bayer...12 at SensorBitDepth = 12-Bit

<sup>2</sup> The three dots... represent the colors of a Bayer pixel format, such as in BayerRG8.

<sup>3</sup> The SensorBitDepth value must be set separately from PixelFormat.  
 See [Sensor ADC readout modes for maximum frame rates](#) on page 72 for details.

Table 35: Alvium 1800 C-040m/c ROI frame rates



## Alvium 1800 C-052m/c

Red table border lines signal that **GeniCam for CSI-2 Access** is required.

Feature	Specification	
	1800 C-052m (monochrome)	1800 C-052c (color)
Sensor model	Sony IMX426	
Resolution	816 (H) × 624 (V); 0.5 MP	
Sensor type	CMOS	
Shutter type	Global shutter (GS)	
Sensor size	Type 1/1.7; 7.3 mm × 5.6 mm; 9.2 mm diagonal	
Pixel size	9.0 μm × 9.0 μm	
CRA	0 deg	
Sensor bit depth (ADC)	8-bit, 10-bit, 12-bit; Adaptive (10-bit, 12-bit)	
Sensor bit depth (ADC)	12-bit	
<b>Pixel formats, GeniCam for CSI-2 Access</b>		
Monochrome pixel formats	Mono8 (default), Mono10, Mono10p, Mono12, Mono12p	Mono8, Mono10, Mono10p, Mono12, Mono12p
YUV color pixel formats	Not applicable	YCbCr411_8_CbYYCrYY, YCbCr422_8_CbYCrY, YCbCr8_CbYCr
RGB color pixel formats	Not applicable	BGR8, RGB8 (default)
Raw color pixel formats	Not applicable	BayerRG8, BayerRG10, BayerRG10p, BayerRG12, BayerRG12p
<b>Pixel formats, other access modes</b>		
YUV color pixel formats	Not applicable	YUV422 8-bit (UYVY)
RGB color pixel formats	Default: RGB888 (RGB3)	
RAW pixel formats	RAW8 (GREY), RAW10 (Y10), RAW12 (Y12)	
Maximum frame rate	689 fps, using 4 lanes	
Maximum frame rate	499 fps, using 4 lanes	
Exposure time	24 μs to 10 s (4 lanes)	
Exposure modes	Timed, TriggerControlled, TriggerWidth	
Gain	0 dB to 48 dB; 0.1 dB increments	
Digital binning	Horizontal: 1 to 8 columns; Vertical: 1 to 8 rows	
Image buffer (RAM)	256 KByte	
Non-volatile memory (Flash)	1024 KByte	
GPIOs	2 programmable GPIOs As direct inputs (push-pull): 0 to 5.5 VDC As direct outputs (push-pull): 0 to 3.3 VDC at 12 mA	
Power requirements	Power over MIPI CSI-2	

Table 36: Alvium 1800 C-052m/c specifications (sheet 1 of 2)

Feature	Specification			
	<b>1800 C-052m/c</b>			
Power consumption (typical, at 5 VDC)	3.8 W			
Storage temperature	-20 °C to +85 °C ambient temperature			
<b>Operating temperature</b>	<b>Hardware option</b>	<b>Housing</b>	<b>Cooling area<sup>1</sup></b>	<b>Mainboard<sup>2</sup></b>
	Bare board <sup>3</sup>	Not applicable	-20 °C to +85 °C	-20 °C to +85 °C
	Open housing <sup>4</sup>	-20 °C to +65 °C		
Relative humidity	0% to 80% (non-condensing)			
Digital interface	MIPI CSI-2 D-PHY V1.1; 1, 2, or 4 lanes; maximum 1.051 Gbit/s per lane			
Camera controls	GenICam (GenICam for CSI-2 Access) V4L2 controls (Video4Linux Access), Direct Register Access			
<sup>1</sup> See <a href="#">Mounting the heat sink</a> on page 256. <sup>2</sup> Output by <code>DeviceTemperature</code> <sup>3</sup> Ensure that the sensor is operated in the temperature range specified by the manufacturer. For any questions, please visit <a href="http://www.alliedvision.com/en/support">www.alliedvision.com/en/support</a> . <sup>4</sup> Temperature values must be observed for the housing <b>and</b> for the cooling area.				

Table 36: Alvium 1800 C-052m/c specifications (sheet 2 of 2)

## Absolute QE, spectral response

We intend to add diagrams in a future version of this document.



## Frame rates with Cropping

Values were calculated as defined in [Frame rates with ROI/Cropping](#) on page 71 and in [Operation for maximum frame rates](#) on page 73.

Frame rates at maximum bandwidth calculates for 1.051 Gbit/s per lane. To reach the maximum frame rate available for typical operation, the bandwidth for image traffic is at 4 lanes with 4.204 Gbit/s.

Image format	Width [pixels]	Height [pixels]	ROI area [MP]	Frame rate [fps] <sup>1</sup>		
				4-lane	2-lane	1-lane
				4.204 Gbit/s	2.102 Gbit/s	1.051 Gbit/s
Full resolution	816	624	0.509	689.3 / 407.2 / 414.2	415.1 / 210.4 / 215.4	211.4 / 106.7 / 108.9
SVGA	800	600	0.480	703.5 / 424.8 / 434.2	431.3 / 219.6 / 223.1	219.7 / 111.5 / 113.5
VGA	640	480	0.307	851.7 / 633.0 / 621.7	641.5 / 330.8 / 337.0	332.8 / 168.2 / 172.2
HVGA	480	320	0.154	1154.2 / 955.4 / 849.9	1154.2 / 589.5 / 605.9	600.0 / 303.4 / 313.3
QVGA	320	240	0.077	1414.4 / 1171.9 / 1053.7	1414.4 / 1053.4 / 1053.7	1067.5 / 551.3 / 573.1
HQVGA	240	160	0.038	1801.8 / 1500.0 / 1366.5		1801.8 / 927.8 / 974.7
QQVGA	160	120	0.019	2044.8 / 1704.5 / 1565.7		2044.8 / 1531.9 / 1565.7
Max. x half	816	312	0.255	1118.8 / 669.4 / 686.8	685.3 / 350.9 / 363.6	353.2 / 179.2 / 185.2
Max. x min.	816	16	0.013	2967.2 / 1880.7 / 2008.3	1963.5 / 1057.5 / 1164.6	1074.0 / 557.4 / 618.1
Min. x max.	16	624	0.010	722.2 / 597.6 / 524.7		
Min. x min.	16	16	256 P	3688.9 / 3103.4 / 2997.8		

<sup>1</sup> Mono8 or Bayer...8<sup>(2)</sup> at **SensorBitDepth** = 8-Bit<sup>(3)</sup> /  
 Mono10 or Bayer...10 at **SensorBitDepth** = 10-Bit  
 Mono12 or Bayer...12 at **SensorBitDepth** = 12-Bit

<sup>2</sup> The three dots... represent the colors of a Bayer pixel format, such as in Bayer**RG8**.

<sup>3</sup> The **SensorBitDepth** value must be set separately from **PixelFormat**.

See [Sensor ADC readout modes for maximum frame rates](#) on page 72 for details.

Table 37: Alvium 1800 C-052m/c ROI frame rates



## Alvium 1800 C-130 VSWIR

Red table border lines signal that **GenICam for CSI-2 Access** is required.

Feature	Specification
	<b>1800 C-130 VSWIR</b>
Sensor model	Sony IMX990
Resolution	1296 (H) × 1032 (V); 1.3 MP
Sensor type	InGaAs
Shutter type	Global shutter (GS)
Sensor size	Type 1/2; 6.4 mm × 5.1 mm; 8.2 mm diagonal
Pixel size	5 μm × 5 μm
CRA	0 deg
Sensor bit depth (ADC)	8-bit, 10-bit, 12-bit; Adaptive (10-bit, 12-bit)
Sensor bit depth (ADC)	12-bit
	<b>Pixel formats, GenICam for CSI-2 Access</b>
Monochrome pixel formats	Mono8 (default), Mono10, Mono10p, Mono12, Mono12p
	<b>Pixel formats, other access modes</b>
RAW pixel formats	RAW8 (GREY), RAW10 (Y10), RAW12 (Y12)
Maximum frame rate	130 fps, using 2 to 4 lanes
Maximum frame rate	69 fps, using 1 to 4 lanes
Exposure time	15 μs to 10 s (1 lane)
Exposure modes	Timed, TriggerControlled, TriggerWidth
Gain	0 dB to 42 dB; 0.1 dB increments
Digital binning	Horizontal: 1 to 8 columns; Vertical: 1 to 8 rows
Image buffer (RAM)	256 KByte
Non-volatile memory (Flash)	1024 KByte
GPIOs	2 programmable GPIOs As direct inputs (push-pull): 0 to 5.5 VDC As direct outputs (push-pull): 0 to 3.3 VDC at 12 mA
Power requirements	Power over MIPI CSI-2
Power consumption (typical, at 5 VDC)	1.9 W
Storage temperature	-20 °C to +85 °C ambient temperature

Table 38: Alvium 1800 C-130 VSWIR specifications (sheet 1 of 2)

Feature	Specification			
	1800 C-130 VSWIR			
Operating temperature	Hardware option	Housing	Cooling area <sup>1</sup>	Mainboard <sup>2</sup>
	Bare board <sup>3</sup>	Not applicable	-20 °C to +85 °C	-20 °C to +85 °C
	Open housing <sup>4</sup>	-20 °C to +65 °C		
Relative humidity	0% to 80% (non-condensing)			
Digital interface	MIPI CSI-2 D-PHY V1.1; 1, 2, or 4 lanes; maximum 1.051 Gbit/s per lane			
Camera controls	GenICam (GenICam for CSI-2 Access) V4L2 controls (Video4Linux Access), Direct Register Access			

<sup>1</sup> See [Mounting the heat sink](#) on page 256.

<sup>2</sup> Output by `DeviceTemperature`

<sup>3</sup> Ensure that the sensor is operated in the temperature range specified by the manufacturer. For any questions, please visit [www.alliedvision.com/en/support](http://www.alliedvision.com/en/support).

<sup>4</sup> Temperature values must be observed for the housing **and** for the cooling area.

Table 38: Alvium 1800 C-130 VSWIR specifications (sheet 2 of 2)

### Absolute QE

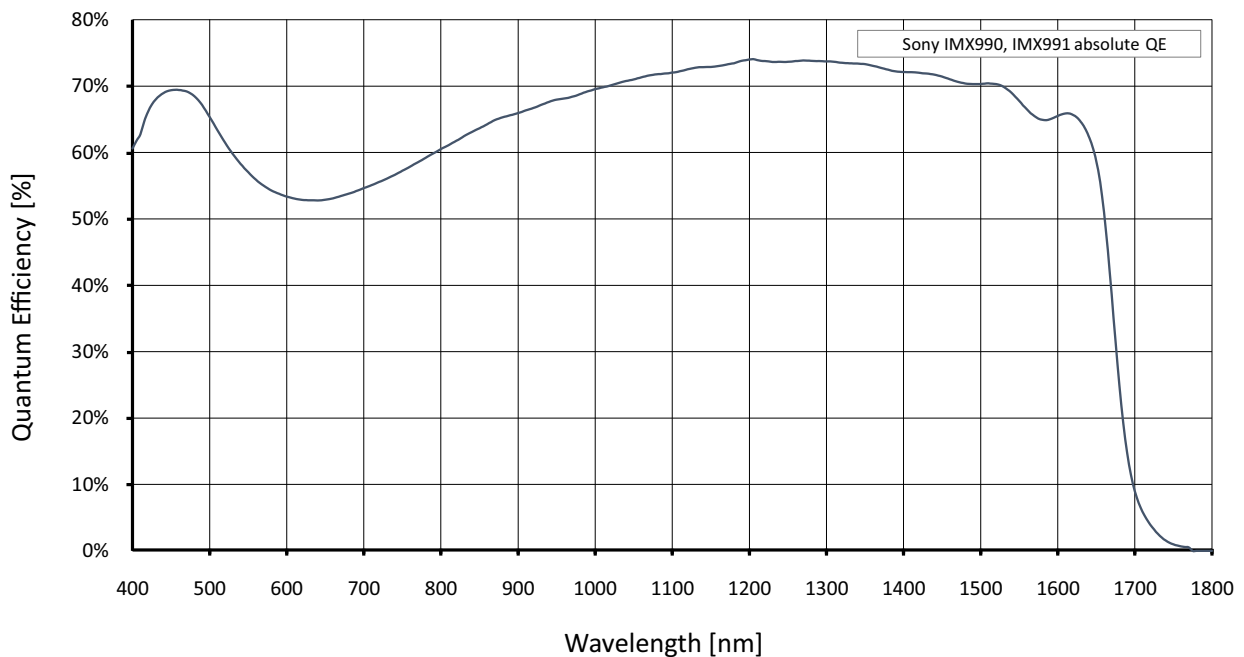

Figure 24: Alvium 1800 C-130 VSWIR (Sony IMX990) absolute QE

## Frame rates with Cropping

Values were calculated as defined in [Frame rates with ROI/Cropping](#) on page 71 and in [Operation for maximum frame rates](#) on page 73.

Frame rates at maximum bandwidth calculates for 1.051 Gbit/s per lane. To reach the maximum frame rate available for typical operation, the bandwidth for image traffic is at 2 lanes with 2.102 Gbit/s. Increasing the CSI-2 Lane Count value does not increase frame rates.

Image format	Width [pixels]	Height [pixels]	ROI area [MP]	Frame rate [fps] <sup>1</sup>		
				4-lane	2-lane	1-lane
				4.204 Gbit/s	2.102 Gbit/s	1.051 Gbit/s
Full resolution	1296	1032	1.337	130.9 / 121.3 / 69.8	130.9 / 92.7 / 69.8	92.8 / 46.8 / 46.7
SXGA	1280	1024	1.311	131.8 / 122.2 / 70.3	131.8 / 94.7 / 70.3	95.0 / 47.6 / 47.7
HD 720	1280	720	0.922	183.3 / 169.8 / 97.8	183.3 / 131.6 / 97.8	132.3 / 66.3 / 66.4
XGA	1024	768	0.786	173.3 / 160.5 / 92.4	173.3 / 155.0 / 92.4	155.6 / 78.1 / 78.1
SVGA	800	600	0.480	218.3 / 202.4 / 116.4		218.3 / 125.8 / 116.4
VGA	640	480	0.307	268.4 / 248.3 / 143.0		268.4 / 192.5 / 143.0
HVGA	480	320	0.154	384.9 / 356.4 / 205.2		
QVGA	320	240	0.077	494.1 / 457.2 / 262.7		
HQVGA	240	160	0.038	686.5 / 634.4 / 365.0		
QQVGA	160	120	0.019	849.9 / 789.2 / 454.6		
Max. × half <sup>3</sup>	1296	520	0.674	246.6 / 228.2 / 131.8	246.6 / 174.8 / 131.8	175.4 / 88.6 / 88.5
Max. × min.	1296	16	0.021	1903.8 / 1721.9 / 1054.5	1903.8 / 1365.1 / 1054.5	1420.9 / 745.3 / 735.0
Min. × max.	16	1032	0.017	132.5 / 123.0 / 70.4		
Min. × min.	16	16	256 P	2303.0 / 2138.5 / 1224.5		

<sup>1</sup> Mono8 at SensorBitDepth = 8-Bit<sup>(2)</sup> /  
 Mono10 at SensorBitDepth = 10-Bit  
 Mono12 at SensorBitDepth = 12-Bit

<sup>2</sup> The SensorBitDepth value must be set separately from PixelFormat.  
 See [Sensor ADC readout modes for maximum frame rates](#) on page 72 for details.

<sup>3</sup> Instead of 1296 × 516  
 If resolutions were not available due to increments, frame rates relate to the next available resolution.

Figure 25: Alvim 1800 C-130 VSWIR ROI frame rates



## Alvium 1800 C-158m/c

Red table border lines signal that **GenICam for CSI-2 Access** is required.

Feature	Specification	
	1800 C-158m (monochrome)	1800 C-158c (color)
Sensor model	Sony IMX273	
Resolution	1456 (H) × 1088 (V); 1.6 MP	
Sensor type	CMOS	
Shutter type	Global shutter (GS)	
Sensor size	Type 1/2.9; 5.0 mm × 3.8 mm; 6.3 mm diagonal	
Pixel size	3.45 μm × 3.45 μm	
CRA	0 deg	
Sensor bit depth (ADC)	8-bit, 10-bit, 12-bit; Adaptive (10-bit, 12-bit)	
Sensor bit depth (ADC)	12-bit	
<b>Pixel formats, GenICam for CSI-2 Access</b>		
Monochrome pixel formats	Mono8 (default), Mono10, Mono10p, Mono12, Mono12p	Mono8, Mono10, Mono10p, Mono12, Mono12p
YUV color pixel formats	Not applicable	YCbCr411_8_CbYYCrYY, YCbCr422_8_CbYCrY, YCbCr8_CbYCr
RGB color pixel formats	Not applicable	BGR8, RGB8 (default)
Raw color pixel formats	Not applicable	BayerRG8, BayerRG10, BayerRG10p, BayerRG12, BayerRG12p
<b>Pixel formats, other access modes</b>		
YUV color pixel formats	Not applicable	YUV422 8-bit (UYVY)
RGB color pixel formats	Default: RGB888 (RGB3)	
RAW pixel formats	RAW8 (GREY), RAW10 (Y10), RAW12 (Y12)	
Maximum frame rate	262 fps, using 4 lanes	
Maximum frame rate	153 fps, using 4 lanes	
Exposure time	28 μs to 10 s (4 lanes)	
Exposure modes	Timed, TriggerControlled, TriggerWidth	
Gain	0 dB to 48 dB; 0.1 dB increments	
Digital binning	Horizontal: 1 to 8 columns; Vertical: 1 to 8 rows	
Sensor binning (H × V)	1 × 2, 2 × 2 ( <i>Sum</i> )	Not applicable
Image buffer (RAM)	256 KByte	
Non-volatile memory (Flash)	1024 KByte	
GPIOs	2 programmable GPIOs As direct inputs (push-pull): 0 to 5.5 VDC As direct outputs (push-pull): 0 to 3.3 VDC at 12 mA	
Power requirements	Power over MIPI CSI-2	

Table 39: Alvium 1800 C-158m/c specifications (sheet 1 of 2)

Feature	Specification			
	<b>1800 C-158m/c</b>			
Power consumption (typical, at 5 VDC)	2.4 W			
Storage temperature	-20 °C to +85 °C ambient temperature			
<b>Operating temperature</b>	<b>Hardware option</b>	<b>Housing</b>	<b>Cooling area<sup>1</sup></b>	<b>Mainboard<sup>2</sup></b>
	Bare board <sup>3</sup>	Not applicable	-20 °C to +85 °C	-20 °C to +85 °C
	Open housing <sup>4</sup>	-20 °C to +65 °C		
Relative humidity	0% to 80% (non-condensing)			
Digital interface	MIPI CSI-2 D-PHY V1.1; 1, 2, or 4 lanes; maximum 1.051 Gbit/s per lane			
Camera controls	GenICam (GenICam for CSI-2 Access)			
	V4L2 controls (Video4Linux Access), Direct Register Access			
<sup>1</sup> See <a href="#">Mounting the heat sink</a> on page 256. <sup>2</sup> Output by <code>DeviceTemperature</code> <sup>3</sup> Ensure that the sensor is operated in the temperature range specified by the manufacturer. For any questions, please visit <a href="http://www.alliedvision.com/en/support">www.alliedvision.com/en/support</a> . <sup>4</sup> Temperature values must be observed for the housing <b>and</b> for the cooling area.				

Table 39: Alvium 1800 C-158m/c specifications (sheet 2 of 2)

### Absolute QE

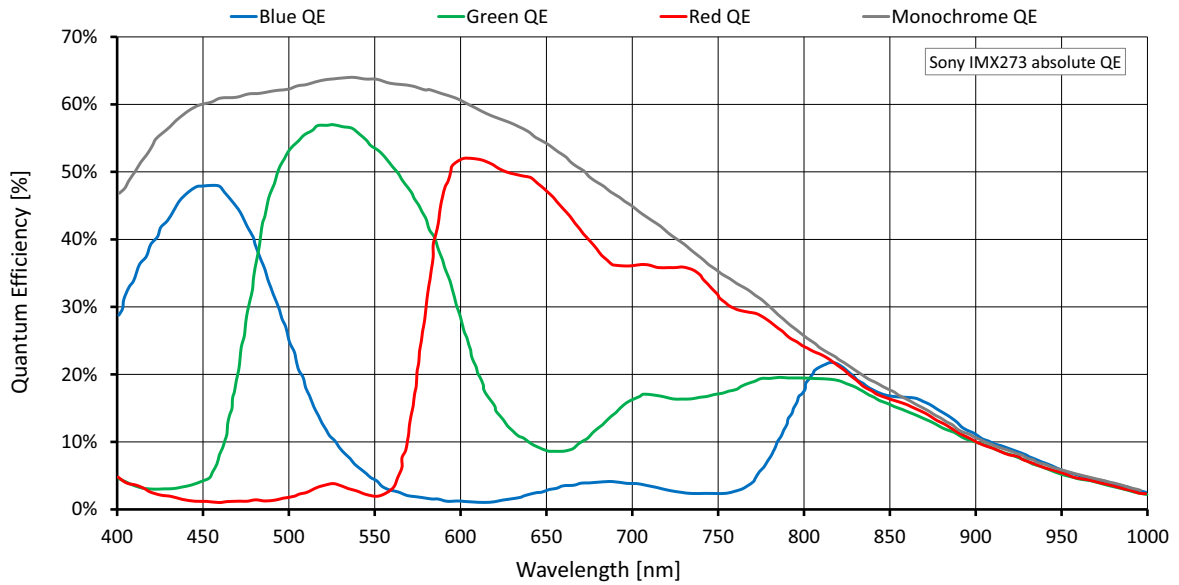

Figure 26: Alvium 1800 C-158m/c (Sony IMX273) absolute QE

### Spectral response

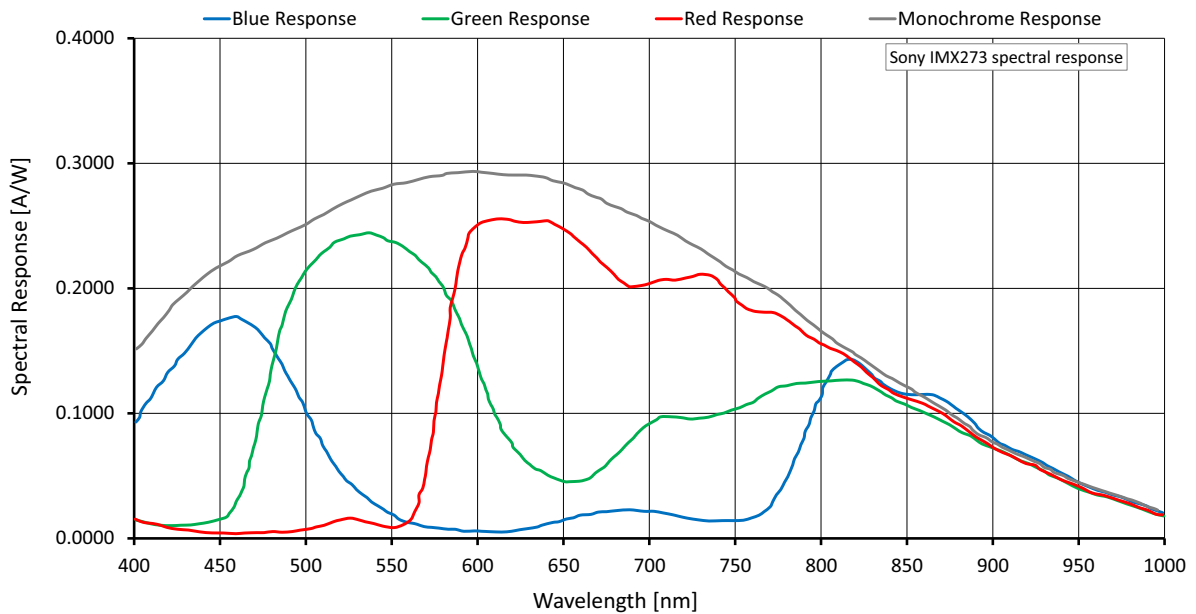

Figure 27: Alvium 1800 C-158m/c (Sony IMX273) spectral response

## Frame rates with Cropping

Values were calculated as defined in [Frame rates with ROI/Cropping](#) on page 71 and in [Operation for maximum frame rates](#) on page 73.

Frame rates at maximum bandwidth calculates for 1.051 Gbit/s per lane. To reach the maximum frame rate available for typical operation, the bandwidth for image traffic is at 4 lanes with 4.204 Gbit/s.

Image format	Width [pixels]	Height [pixels]	ROI area [MP]	Frame rate [fps] <sup>1</sup>		
				4-lane	2-lane	1-lane
				4.204 Gbit/s	2.102 Gbit/s	1.051 Gbit/s
Full resolution	1456	1088	1.584	262.2 / 153.3 / 153.0	155.1 / 78.1 / 77.6	78.3 / 39.3 / 39.2
WXGA+ <sup>4</sup>	1440	904	1.302	310.6 / 184.2 / 184.0	186.1 / 94.0 / 93.6	94.1 / 47.4 / 47.2
SXGA	1280	1024	1.311	278.2 / 184.4 / 167.2	185.8 / 94.0 / 93.7	94.3 / 47.3 / 47.4
HD 720	1280	720	0.922	382.9 / 254.6 / 230.6	256.9 / 130.5 / 129.8	131.0 / 65.8 / 65.8
XGA	1024	768	0.786	364.4 / 296.5 / 218.8	301.3 / 153.7 / 152.6	154.1 / 77.5 / 77.4
SVGA	800	600	0.480	457.7 / 372.9 / 275.7	457.7 / 245.4 / 243.8	245.6 / 124.7 / 124.2
VGA	640	480	0.307	560.5 / 456.8 / 337.7	560.5 / 373.3 / 337.7	375.7 / 190.0 / 189.4
HVGA	480	320	0.154	797.4 / 650.4 / 482.2		660.5 / 359.5 / 357.9
QVGA	320	240	0.077	1004.5 / 830.7 / 617.7		833.7 / 680.4 / 617.7
HQVGA	240	160	0.038	1356.9 / 1138.9 / 847.2		1130.1 / 1138.9 / 847.2
QQVGA	160	120	0.019	1645.6 / 1390.6 / 1037.7		1374.5 / 1390.6 / 1037.7
Max. × half	1456	544	0.792	486.4 / 287.2 / 285.6	291.6 / 147.8 / 146.5	148.4 / 74.8 / 74.5
Max. × min.	1456	16	0.023	2864.6 / 1883.3 / 1793.5	2002.4 / 1111.1 / 1067.5	1140.6 / 608.1 / 592.1
Min. × max.	16	1088	0.017	267.6 / 219.1 / 161.2		220.5 / 219.1 / 161.2
Min. × min.	16	16	256 P	3683.0 / 3268.8 / 2496.0		3139.3 / 3268.8 / 2496.0

<sup>1</sup> Mono8 or Bayer...8<sup>(2)</sup> at **SensorBitDepth** = 8-Bit<sup>(3)</sup> /  
 Mono10 or Bayer...10 at **SensorBitDepth** = 10-Bit  
 Mono12 or Bayer...12 at **SensorBitDepth** = 12-Bit

<sup>2</sup> The three dots... represent the colors of a Bayer pixel format, such as in BayerRG8.

<sup>3</sup> The **SensorBitDepth** value must be set separately from **PixelFormat**.

See [Sensor ADC readout modes for maximum frame rates](#) on page 72 for details.

<sup>4</sup> Instead of 1440 × 900

If resolutions were not available due to increments, frame rates relate to the next available resolution.

Figure 28: Alvium 1800 C-158m/c ROI frame rates





## Alvium 1800 C-203m/c

Red table border lines signal that **GeniCam for CSI-2 Access** is required.

Feature	Specification	
	1800 C-203m (monochrome)	1800 C-203c (color)
Sensor model	IMX422	
Resolution	1632 (H) × 1248 (V); 2.03 MP	
Sensor type	CMOS	
Shutter type	Global shutter (GS)	
Sensor size	Type 1/1.7; 7.3 mm × 5.6 mm; 9.2 mm diagonal	
Pixel size	4.5 μm × 4.5 μm	
CRA	0° deg	
Sensor bit depth (ADC)	8-bit, 10-bit, 12-bit; Adaptive (10-bit, 12-bit)	
Sensor bit depth (ADC)	12-bit	
<b>Pixel formats, GeniCam for CSI-2 Access</b>		
Monochrome pixel formats	Mono8 (default), Mono10, Mono10p, Mono12, Mono12p	Mono8, Mono10, Mono10p, Mono12, Mono12p
YUV color pixel formats	Not applicable	YCbCr411_8_CbYYCrYY, YCbCr422_8_CbYCrY, YCbCr8_CbYCr
RGB color pixel formats	Not applicable	BGR8, RGB8 (default)
Raw color pixel formats	Not applicable	BayerRG8, BayerRG10, BayerRG10p, BayerRG12, BayerRG12p
<b>Pixel formats, other access modes</b>		
YUV color pixel formats	Not applicable	YUV422 8-bit (UYVY)
RGB color pixel formats	Default: RGB888 (RGB3)	
RAW pixel formats	RAW8 (GREY), RAW10 (Y10), RAW12 (Y12)	
Maximum frame rate	225 fps, using 1 to 4 lanes	
Maximum frame rate	156 fps, using 4 lanes	
Exposure time	18 μs to 10 s (4 lanes)	
Exposure modes	Timed	
Gain	0 dB to 48 dB; 0.1 dB increments	
Digital binning	Horizontal: 1 to 8 columns; Vertical: 1 to 8 rows	
Sensor binning (H × V)	2 × 2 ( <i>Sum, Average</i> )	Not applicable
Image buffer (RAM)	256 KByte	
Non-volatile memory (Flash)	1024 KByte	
GPIOs	2 programmable GPIOs As direct inputs (push-pull): 0 to 5.5 VDC As direct outputs (push-pull): 0 to 3.3 VDC at 12 mA	
Power requirements	Power over MIPI CSI-2	

Table 40: Alvium 1800 C-203m/c specifications (sheet 1 of 2)

Feature	Specification			
	1800 C-203m (monochrome)		1800 C-203c (color)	
Power consumption (typical, at 5 VDC)	3.1 W			
Storage temperature	-20 °C to +85 °C ambient temperature			
<b>Operating temperature</b>	<b>Hardware option</b>	<b>Housing</b>	<b>Cooling area<sup>1</sup></b>	<b>Mainboard<sup>2</sup></b>
	Bare board <sup>3</sup>	Not applicable	-20 °C to +85 °C	-20 °C to +85 °C
	Open housing <sup>4</sup>	-20 °C to +65 °C		
Relative humidity	0% to 80% (non-condensing)			
Digital interface	MIPI CSI-2 D-PHY V1.1; 1, 2, or 4 lanes; maximum 1.051 Gbit/s per lane			
Camera controls	GenICam (GenICam for CSI-2 Access)			
	V4L2 controls (Video4Linux Access), Direct Register Access			
<sup>1</sup> See <a href="#">Mounting the heat sink</a> on page 256. <sup>2</sup> Output by DeviceTemperature <sup>3</sup> Ensure that the sensor is operated in the temperature range specified by the manufacturer. For any questions, please visit <a href="http://www.alliedvision.com/en/support">www.alliedvision.com/en/support</a> . <sup>4</sup> Temperature values must be observed for the housing <b>and</b> for the cooling area.				

Table 40: Alvium 1800 C-203m/c specifications (sheet 2 of 2)

## Absolute QE, spectral response

We intend to add diagrams in a future version of this document.

## ROI frame rates

Values were calculated as defined in [Frame rates with ROI/Cropping](#) on page 71 and in [Operation for maximum frame rates](#) on page 73.

Frame rates at maximum bandwidth calculates for 1.051 Gbit/s per lane. To reach the maximum frame rate available for typical operation, the bandwidth for image traffic is at 4 lanes with 4.204 Gbit/s.

Image format	Width [pixels]	Height [pixels]	ROI area [MP]	Frame rate [fps] <sup>1</sup>		
				4-lane	2-lane	1-lane
				4.204 Gbit/s	2.102 Gbit/s	1.051 Gbit/s
Full resolution	1632	1248	2.037	225.8 / 118.0 / 118.7	118.8 / 60.0 / 60.1	60.1 / 30.2 / 30.2
UXGA	1600	1200	1.920	234.2 / 125.0 / 124.7	125.3 / 63.5 / 63.5	63.5 / 31.9 / 32.0
WXGA+ <sup>4</sup>	1440	904	1.302	303.0 / 179.5 / 180.0	181.3 / 91.6 / 91.5	91.6 / 46.1 / 46.1
SXGA	1280	1024	1.311	272.1 / 180.2 / 179.5	181.5 / 91.8 / 91.8	92.1 / 46.2 / 46.4
HD 720	1280	720	0.922	371.4 / 246.6 / 245.6	248.8 / 126.3 / 126.3	126.8 / 63.7 / 64.0
XGA	1024	768	0.786	354.0 / 288.0 / 245.5	292.6 / 149.0 / 148.7	149.4 / 75.1 / 75.4
SVGA	800	600	0.480	441.3 / 359.6 / 307.0	441.3 / 236.2 / 236.0	236.3 / 120.0 / 120.2
VGA	640	480	0.307	536.2 / 437.0 / 373.7	536.2 / 356.3 / 355.9	358.5 / 181.3 / 182.0
HVGA	480	320	0.154	750.9 / 610.9 / 524.2		665.8 / 336.4 / 338.3
QVGA	320	240	0.077	943.2 / 767.4 / 660.6		943.2 / 625.9 / 630.0
HQVGA	240	160	0.038	1257.6 / 1027.3 / 885.3		
QQVGA	160	120	0.019	1516.5 / 1239.9 / 1077.6		
Max. × half	1632	624	1.018	414.7 / 219.0 / 220.2	221.3 / 112.3 / 112.5	112.7 / 56.8 / 56.9
Max. × min.	1632	16	0.026	2241.8 / 1319.7 / 1317.3	1391.5 / 750.2 / 758.1	765.3 / 402.4 / 410.0
Min. × max.	16	1248	0.020	232.8 / 189.5 / 161.3		
Min. × min.	16	16	256 P	3189.4 / 2621.8 / 2344.6		

<sup>1</sup> Mono8 or Bayer...8<sup>(2)</sup> at **SensorBitDepth** = 8-Bit<sup>(3)</sup> /  
 Mono10 or Bayer...10 at **SensorBitDepth** = 10-Bit  
 Mono12 or Bayer...12 at **SensorBitDepth** = 12-Bit

<sup>2</sup> The three dots... represent the colors of a Bayer pixel format, such as in BayerRG8.

<sup>3</sup> The **SensorBitDepth** value must be set separately from **PixelFormat**.

See [Sensor ADC readout modes for maximum frame rates](#) on page 72 for details.

<sup>4</sup> Instead of 1440 × 900

If resolutions were not available due to increments, frame rates relate to the next available resolution.

Table 41: Alvium 1800 C-203m/c ROI frame rates



## Alvium 1800 C-234m/c

Red table border lines signal that **GenICam for CSI-2 Access** is required.

Feature	Specification	
	1800 C-234m (monochrome)	1800 C-234c (color)
Sensor model	Sony IMX249	
Resolution	1936 (H) × 1216 (V); 2.35 MP	
Sensor type	CMOS	
Shutter type	Global shutter (GS)	
Sensor size	Type 1/1.2; 11.3 mm × 7.1 mm; 13.4 mm diagonal	
Pixel size	5.86 μm × 5.86 μm	
CRA	0 deg	
Sensor bit depth (ADC)	10-bit, 12-bit; Adaptive (10-bit, 12-bit)	
Sensor bit depth (ADC)	12-bit	
<b>Pixel formats, GenICam for CSI-2 Access</b>		
Monochrome pixel formats	Mono8 (default), Mono10, Mono10p, Mono12, Mono12p	Mono8, Mono10, Mono10p, Mono12, Mono12p
YUV color pixel formats	Not applicable	YCbCr411_8_CbYYCrYY, YCbCr422_8_CbYCrY, YCbCr8_CbYCr
RGB color pixel formats	Not applicable	BGR8, RGB8 (default)
Raw color pixel formats	Not applicable	BayerRG8, BayerRG10, BayerRG10p, BayerRG12, BayerRG12p
<b>Pixel formats, other access modes</b>		
YUV color pixel formats	Not applicable	YUV422 8-bit (UYVY)
RGB color pixel formats	Default: RGB888 (RGB3)	
RAW pixel formats	RAW8 (GREY), RAW10 (Y10), RAW12 (Y12)	
Maximum frame rate	40 fps, using 1 to 4 lanes	
Maximum frame rate	31 fps, using 1 to 4 lanes	
Exposure time	34 μs to 10 s (1 lane)	
Exposure modes	Timed	
Gain	0 dB to 48 dB; 0.1 dB increments	
Digital binning	Horizontal: 1 to 8 columns; Vertical: 1 to 8 rows	
Image buffer (RAM)	256 KByte	
Non-volatile memory (Flash)	1024 KByte	
GPIOs	2 programmable GPIOs As direct inputs (push-pull): 0 to 5.5 VDC As direct outputs (push-pull): 0 to 3.3 VDC at 12 mA	
Power requirements	Power over MIPI CSI-2	
Power consumption (typical, at 5 VDC)	1.9 W	

Table 42: Alvium 1800 C-234m/c specifications (sheet 1 of 2)

Feature	Specification			
	1800 C-234m (monochrome)		1800 C-234c (color)	
Storage temperature	-20 °C to +85 °C ambient temperature			
<b>Operating temperature</b>	<b>Hardware option</b>	<b>Housing</b>	<b>Cooling area<sup>1</sup></b>	<b>Mainboard<sup>2</sup></b>
	Bare board <sup>3</sup>	Not applicable	-20 °C to +85 °C	-20 °C to +85 °C
	Open housing <sup>4</sup>	-20 °C to +65 °C		
Relative humidity	0% to 80% (non-condensing)			
Digital interface	MIPI CSI-2 D-PHY V1.1; 1, 2, or 4 lanes; maximum 1.051 Gbit/s per lane			
Camera controls	GenICam (GenICam for CSI-2 Access)			
	V4L2 controls (Video4Linux Access), Direct Register Access			
<sup>1</sup> See <a href="#">Mounting the heat sink</a> on page 256. <sup>2</sup> Output by <code>DeviceTemperature</code> <sup>3</sup> Ensure that the sensor is operated in the temperature range specified by the manufacturer. For any questions, please visit <a href="http://www.alliedvision.com/en/support">www.alliedvision.com/en/support</a> . <sup>4</sup> Temperature values must be observed for the housing <b>and</b> for the cooling area.				

Table 42: Alvim 1800 C-234m/c specifications (sheet 2 of 2)

### Absolute QE

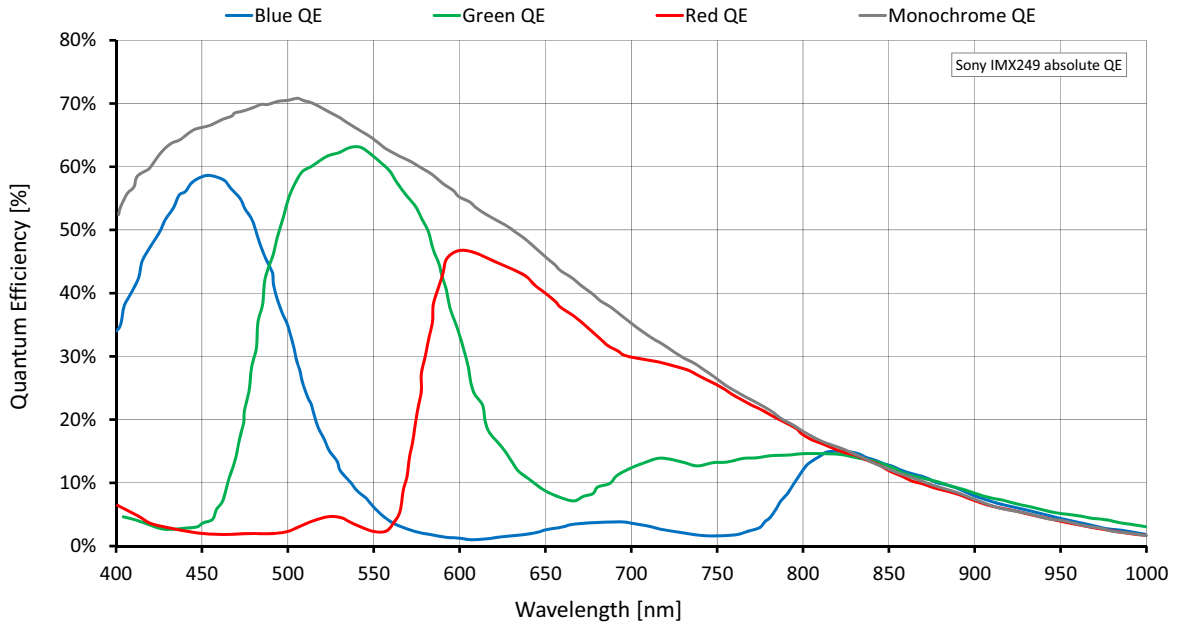

Figure 29: Alvim 1800 C-234m/c (Sony IMX249) absolute QE

### Spectral response

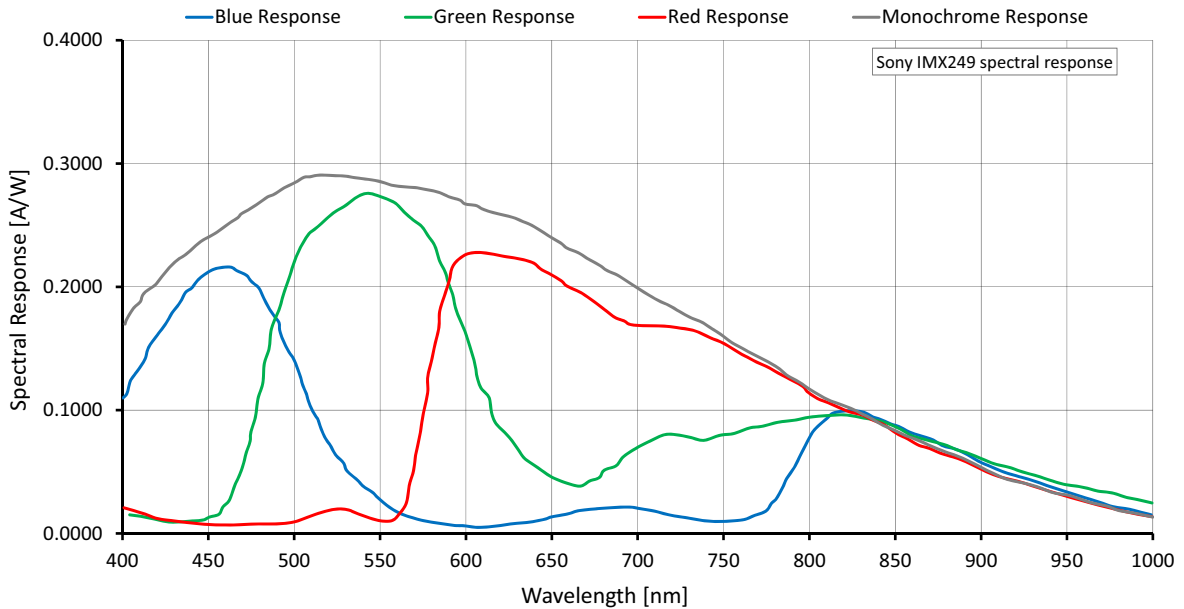

Figure 30: Alvim 1800 C-234m/c (Sony IMX249) spectral response

## ROI frame rates

Values were calculated as defined in [Frame rates with ROI/Cropping](#) on page 71 and in [Operation for maximum frame rates](#) on page 73.

Frame rates at maximum bandwidth calculates for 1.051 Gbit/s per lane. To reach the maximum frame rate available for typical operation, the bandwidth for image traffic is at 1 lane with 1.051 Gbit/s. Increasing the CSI-2 Lane Count value does not increase frame rates.

Image format	Width [pixels]	Height [pixels]	ROI area [MP]	Frame rate [fps] <sup>1</sup>		
				4-lane	2-lane	1-lane
				4.204 Gbit/s	2.102 Gbit/s	1.051 Gbit/s
Full resolution	1936	1216	2.354	40.4 / 31.5		40.4 / 26.7
Full HD	1920	1080	2.074	45.3 / 35.3		45.3 / 30.2
UXGA	1600	1200	1.920	41.0 / 31.9		
WXGA+ <sup>4</sup>	1,440	904	1.302	53.7 / 41.8		
SXGA	1280	1024	1.311	47.7 / 37.2		
HD 720	1280	720	0.922	66.5 / 51.9		
XGA	1024	768	0.786	62.7 / 48.9		
SVGA	800	600	0.480	79.0 / 61.6		
VGA	640	480	0.307	96.9 / 75.5		
HVGA	480	320	0.154	139.2 / 108.5		
QVGA	320	240	0.077	177.8 / 138.5		
HQVGA	240	160	0.038	245.8 / 192.5		
QQVGA	160	120	0.019	305.8 / 238.3		
Max. × half	1936	608	1.177	77.6 / 60.5		77.6 / 51.3
Max. × min.	1936	16	0.031	734.0 / 580.4		734.0 / 498.5
Min. × max.	16	1216	0.019	40.6 / 31.6		
Min. × min.	16	16	256 P	802.8 / 625.7		

<sup>1</sup> Mono8 or Mono10, or Bayer...8 or Bayer...10<sup>(2)</sup> at **SensorBitDepth** = 10-Bit<sup>(3)</sup> / Mono12 or Bayer...12 at **SensorBitDepth** = 12-Bit

<sup>2</sup> The three dots... represent the colors of a Bayer pixel format, such as in Bayer**RG8**.

<sup>3</sup> The **SensorBitDepth** value must be set separately from **PixelFormat**.

See [Sensor ADC readout modes for maximum frame rates](#) on page 72 for details.

<sup>4</sup> Instead of 1440 × 900

If resolutions were not available due to increments, frame rates relate to the next available resolution.

Table 43: Alvium 1800 C-234m/c ROI frame rates



## Alvium 1800 C-235m/c

Red table border lines signal that **GenICam for CSI-2 Access** is required.

Feature	Specification	
	1800 C-235m (monochrome)	1800 C-235c (color)
Sensor model	Sony IMX174	
Resolution	1936 (H) × 1216 (V); 2.35 MP	
Sensor type	CMOS	
Shutter type	Global shutter (GS)	
Sensor size	Type 1/1.2; 11.3 mm × 7.1 mm; 13.4 mm diagonal	
Pixel size	5.86 μm × 5.86 μm	
CRA	0 deg	
Sensor bit depth (ADC)	10-bit, 12-bit; Adaptive (10-bit, 12-bit)	
Sensor bit depth (ADC)	12-bit	
<b>Pixel formats, GenICam for CSI-2 Access</b>		
Monochrome pixel formats	Mono8 (default), Mono10, Mono10p, Mono12, Mono12p	Mono8, Mono10, Mono10p, Mono12, Mono12p
YUV color pixel formats	Not applicable	YCbCr411_8_CbYYCrYY, YCbCr422_8_CbYCrY, YCbCr8_CbYCr
RGB color pixel formats	Not applicable	BGR8, RGB8 (default)
Raw color pixel formats	Not applicable	BayerRG8, BayerRG10, BayerRG10p, BayerRG12, BayerRG12p
<b>Pixel formats, other access modes</b>		
YUV color pixel formats	Not applicable	YUV422 8-bit (UYVY)
RGB color pixel formats	Default: RGB888 (RGB3)	
RAW pixel formats	RAW8 (GREY), RAW10 (Y10), RAW12 (Y12)	
Maximum frame rate	155 fps, using 4 lanes	
Maximum frame rate	121 fps, using 4 lanes	
Exposure time	19 μs to 10 s (4 lanes)	
Exposure modes	Timed	
Gain	0 dB to 48 dB; 0.1 dB increments	
Digital binning	Horizontal: 1 to 8 columns; Vertical: 1 to 8 rows	
Image buffer (RAM)	256 KByte	
Non-volatile memory (Flash)	1024 KByte	
GPIOs	2 programmable GPIOs As direct inputs (push-pull): 0 to 5.5 VDC As direct outputs (push-pull): 0 to 3.3 VDC at 12 mA	
Power requirements	Power over MIPI CSI-2	
Power consumption (typical, at 5 VDC)	2.6 W	

Table 44: Alvium 1800 C-235m/c specifications (sheet 1 of 2)



Feature	Specification			
	1800 C-235m (monochrome)		1800 C-235c (color)	
Storage temperature	-20 °C to +85 °C ambient temperature			
Operating temperature	Hardware option	Housing	Cooling area <sup>1</sup>	Mainboard <sup>2</sup>
	Bare board <sup>3</sup>	Not applicable	-20 °C to +85 °C	-20 °C to +85 °C
	Open housing <sup>4</sup>	-20 °C to +65 °C		
Relative humidity	0% to 80% (non-condensing)			
Digital interface	MIPI CSI-2 D-PHY V1.1; 1, 2, or 4 lanes; maximum 1.051 Gbit/s per lane			
Camera controls	GenICam (GenICam for CSI-2 Access)			
	V4L2 controls (Video4Linux Access), Direct Register Access			
<sup>1</sup> See <a href="#">Mounting the heat sink</a> on page 256. <sup>2</sup> Output by <code>DeviceTemperature</code> <sup>3</sup> Ensure that the sensor is operated in the temperature range specified by the manufacturer. For any questions, please visit <a href="http://www.alliedvision.com/en/support">www.alliedvision.com/en/support</a> . <sup>4</sup> Temperature values must be observed for the housing <b>and</b> for the cooling area.				

Table 44: Alvim 1800 C-235m/c specifications (sheet 2 of 2)

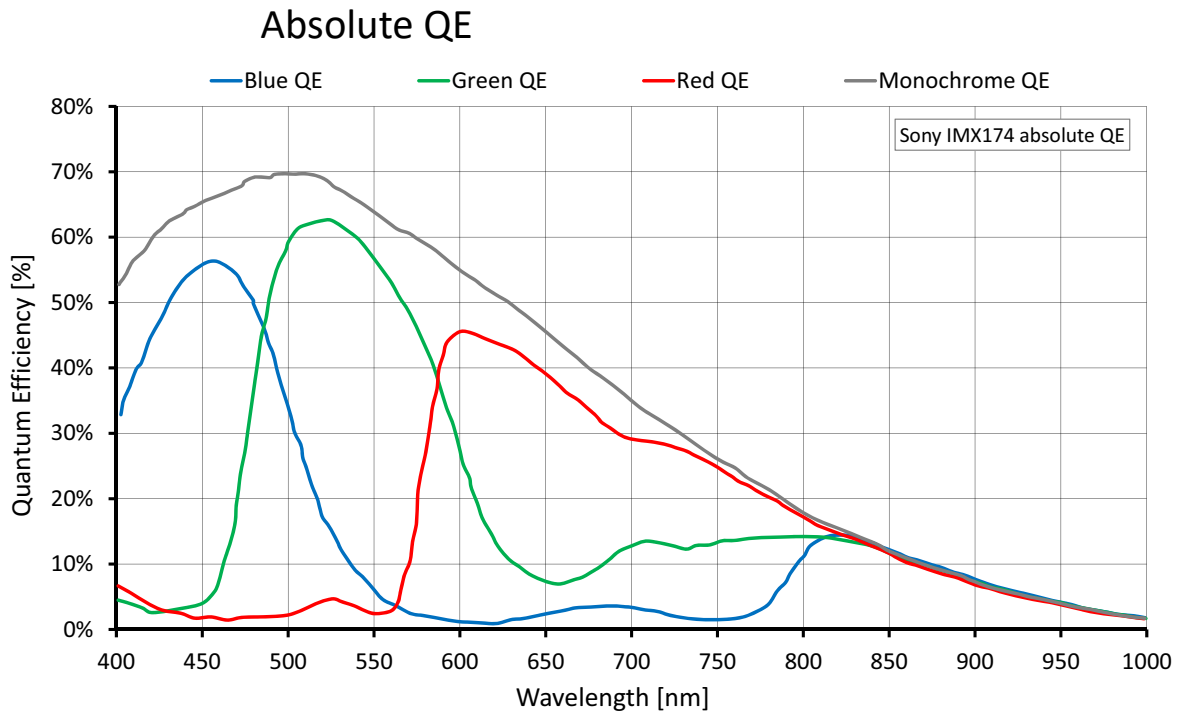

Figure 31: Alvium 1800 C-235m/c (Sony IMX174) absolute QE

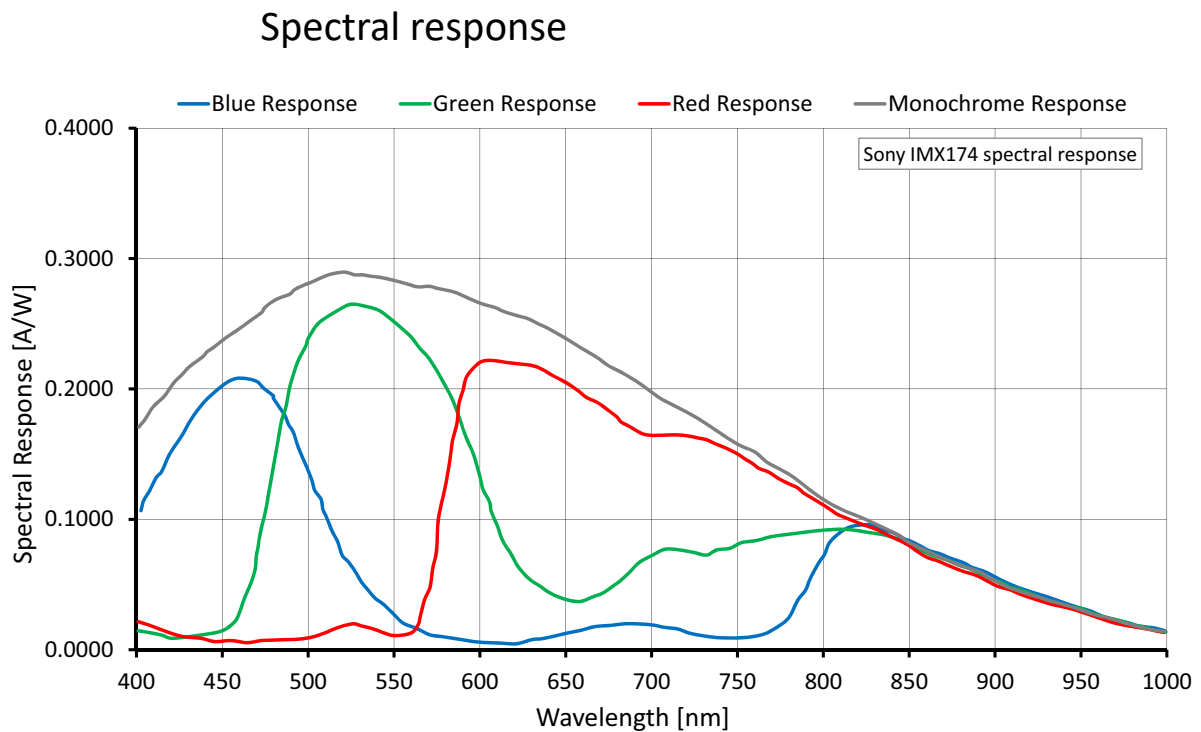

Figure 32: Alvium 1800 C-234m/c (Sony IMX174) spectral response

## ROI frame rates

Values were calculated as defined in [Frame rates with ROI/Cropping](#) on page 71 and in [Operation for maximum frame rates](#) on page 73.

Frame rates at maximum bandwidth calculates for 1.051 Gbit/s per lane. To reach the maximum frame rate available for typical operation, the bandwidth for image traffic is at 4 lanes with 4.204 Gbit/s.

Image format	Width [pixels]	Height [pixels]	ROI area [MP]	Frame rate [fps] <sup>1</sup>		
				4-lane	2-lane	1-lane
				4.204 Gbit/s	2.102 Gbit/s	1.051 Gbit/s
Full resolution	1936	1216	2.354	155.8 / 103.7	104.5 / 52.8	53.1 / 26.6
Full HD	1920	1080	2.074	174.1 / 117.2	117.9 / 59.7	59.9 / 30.0
UXGA	1600	1200	1.920	158.6 / 124.0	127.9 / 64.8	65.0 / 32.6
WXGA+ <sup>4</sup>	1440	904	1.302	207.1 / 161.8	184.9 / 94.0	94.4 / 47.3
SXGA	1280	1024	1.311	185.1 / 144.6	185.1 / 94.0	94.3 / 47.5
HD 720	1280	720	0.922	255.8 / 200.0	255.8 / 130.4	131.1 / 66.1
XGA	1024	768	0.786	242.7 / 189.7	242.7 / 153.3	154.4 / 77.8
SVGA	800	600	0.480	305.9 / 238.9		246.8 / 124.9
VGA	640	480	0.307	376.0 / 293.2		376.0 / 190.8
HVGA	480	320	0.154	538.1 / 420.8		538.1 / 361.6
QVGA	320	240	0.077	689.5 / 539.6		
HQVGA	240	160	0.038	955.0 / 744.8		
QQVGA	160	120	0.019	1189.6 / 927.8		
Max. x half	1936	608	1.177	291.8 / 195.5	197.6 / 100.6	101.3 / 51.0
Max. x min.	1936	16	0.031	1937.3 / 1401.1	1483.5 / 845.2	880.6 / 470.8
Min. x max.	16	1216	0.019	160.6 / 125.3		
Min. x min.	16	16	256 P	3082.2 / 2403.8		

<sup>1</sup> Mono8 or Mono10, or Bayer...8 or Bayer...10<sup>(2)</sup> at **SensorBitDepth** = 10-Bit<sup>(3)</sup> / Mono12 or Bayer...12 at **SensorBitDepth** = 12-Bit

<sup>2</sup> The three dots... represent the colors of a Bayer pixel format, such as in BayerRG8.

<sup>3</sup> The **SensorBitDepth** value must be set separately from **PixelFormat**.

See [Sensor ADC readout modes for maximum frame rates](#) on page 72 for details.

<sup>4</sup> Instead of 1440 x 900

If resolutions were not available due to increments, frame rates relate to the next available resolution.

Table 45: Alvium 1800 C-235m/c ROI frame rates



## Alvium 1800 C-240m/c

Red table border lines signal that **GeniCam for CSI-2 Access** is required.

Feature	Specification	
	1800 C-240m (monochrome)	1800 C-240c (color)
Sensor model	Sony IMX392	
Resolution	1936 (H) x 1216 (V); 2.4 MP	
Sensor type	CMOS	
Shutter type	Global shutter (GS)	
Sensor size	Type 1/2.3; 6.7 mm x 4.2 mm; 7.9 mm diagonal	
Pixel size	3.45 μm x 3.45 μm	
CRA	0 deg	
Sensor bit depth (ADC)	8-bit, 10-bit, 12-bit; Adaptive (10-bit, 12-bit)	
Sensor bit depth (ADC)	12-bit	
<b>Pixel formats, GeniCam for CSI-2 Access</b>		
Monochrome pixel formats	Mono8 (default), Mono10, Mono10p, Mono12, Mono12p	Mono8, Mono10, Mono10p, Mono12, Mono12p
YUV color pixel formats	Not applicable	YCbCr411_8_CbYYCrYY, YCbCr422_8_CbYCrY, YCbCr8_CbYCr
RGB color pixel formats	Not applicable	BGR8, RGB8 (default)
Raw color pixel formats	Not applicable	BayerRG8, BayerRG10, BayerRG10p, BayerRG12, BayerRG12p
<b>Pixel formats, other access modes</b>		
YUV color pixel formats	Not applicable	YUV422 8-bit (UYVY)
RGB color pixel formats	Default: RGB888 (RGB3)	
RAW pixel formats	RAW8 (GREY), RAW10 (Y10), RAW12 (Y12)	
Maximum frame rate	192 fps, using 4 lanes	
Maximum frame rate	126 fps, using 4 lanes	
Exposure time	26 μs to 10 s (4 lanes)	
Exposure modes	Timed, TriggerControlled, TriggerWidth	
Gain	0 dB to 48 dB; 0.1 dB increments	
Digital binning	Horizontal: 1 to 8 columns; Vertical: 1 to 8 rows	
Sensor binning (H x V)	2 x 2 ( <i>Sum</i> )	Not applicable
Image buffer (RAM)	256 KByte	
Non-volatile memory (Flash)	1024 KByte	
GPIOs	2 programmable GPIOs As direct inputs (push-pull): 0 to 5.5 VDC As direct outputs (push-pull): 0 to 3.3 VDC at 12 mA	

Table 46: Alvium 1800 C-240m/c specifications (sheet 1 of 2)

Feature	Specification			
	<b>1800 C-240m/c</b>			
Power requirements	Power over MIPI CSI-2			
Power consumption (typical, at 5 VDC)	2.7 W			
Storage temperature	-20 °C to +85 °C ambient temperature			
<b>Operating temperature</b>	<b>Hardware option</b>	<b>Housing</b>	<b>Cooling area<sup>1</sup></b>	<b>Mainboard<sup>2</sup></b>
	Bare board <sup>3</sup>	Not applicable	-20 °C to +85 °C	-20 °C to +85 °C
	Open housing <sup>4</sup>	-20 °C to +65 °C		
Relative humidity	0% to 80% (non-condensing)			
Digital interface	MIPI CSI-2 D-PHY V1.1; 1, 2, or 4 lanes; maximum 1.051 Gbit/s per lane			
Camera controls	GenICam (GenICam for CSI-2 Access)			
	V4L2 controls (Video4Linux Access), Direct Register Access			
<sup>1</sup> See <a href="#">Mounting the heat sink</a> on page 256. <sup>2</sup> Output by <code>DeviceTemperature</code> <sup>3</sup> Ensure that the sensor is operated in the temperature range specified by the manufacturer. For any questions, please visit <a href="http://www.alliedvision.com/en/support">www.alliedvision.com/en/support</a> . <sup>4</sup> Temperature values must be observed for the housing <b>and</b> for the cooling area.				

Table 46: Alvium 1800 C-240m/c specifications (sheet 2 of 2)

### Absolute QE

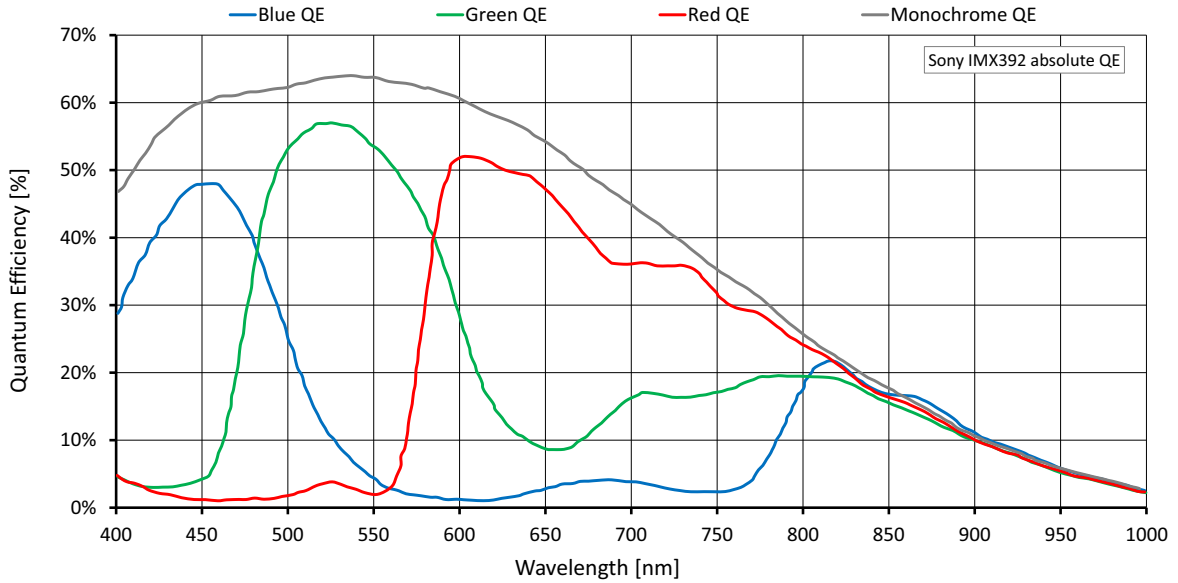

Figure 33: Alvium 1800 C-240m/c (Sony IMX392) absolute QE

### Spectral response

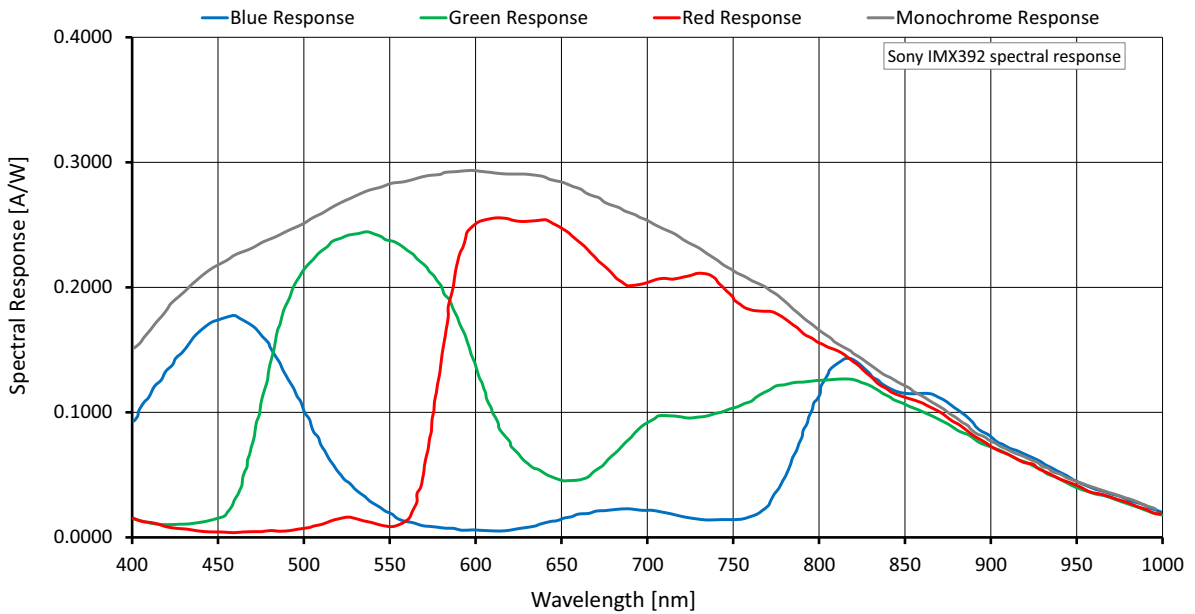

Figure 34: Alvium 1800 C-240m/c (Sony IMX392) spectral response

## Frame rates with Cropping

Values were calculated as defined in [Frame rates with ROI/Cropping](#) on page 71 and in [Operation for maximum frame rates](#) on page 73.

Frame rates at maximum bandwidth calculates for 1.051 Gbit/s per lane. To reach the maximum frame rate available for typical operation, the bandwidth for image traffic is at 4 lanes with 4.204 Gbit/s.

Image format	Width [pixels]	Height [pixels]	ROI area [MP]	Frame rate [fps] <sup>1</sup>		
				4-lane	2-lane	1-lane
				4.204 Gbit/s	2.102 Gbit/s	1.051 Gbit/s
Full resolution	1936	1216	2.354	192.1 / 104.7 / 104.1	105.4 / 53.2 / 53.0	53.2 / 26.7 / 26.7
Full HD	1920	1080	2.074	214.4 / 118.2 / 117.6	118.8 / 60.1 / 60.0	60.0 / 30.2 / 30.2
UXGA	1600	1200	1.920	195.5 / 128.2 / 127.6	128.3 / 65.2 / 65.0	65.0 / 32.8 / 32.7
WXGA+ <sup>4</sup>	1440	904	1.302	254.9 / 185.4 / 171.0	186.8 / 94.6 / 94.4	94.5 / 47.6 / 47.6
SXGA	1280	1024	1.311	227.8 / 185.4 / 152.7	186.5 / 94.6 / 94.3	94.7 / 47.6 / 47.7
HD 720	1280	720	0.922	314.7 / 256.5 / 211.4	258.2 / 131.5 / 131.1	131.7 / 66.3 / 66.5
XGA	1024	768	0.786	299.0 / 246.4 / 200.8	299.0 / 154.8 / 154.1	154.8 / 78.1 / 78.2
SVGA	800	600	0.480	376.1 / 310.6 / 253.0	376.1 / 247.6 / 246.7	247.1 / 125.8 / 125.7
VGA	640	480	0.307	462.0 / 381.2 / 311.4	462.0 / 377.4 / 311.4	378.4 / 192.2 / 192.2
HVGA	480	320	0.154	658.4 / 547.1 / 447.1		658.4 / 365.2 / 365.6
QVGA	320	240	0.077	833.4 / 701.5 / 574.7		833.4 / 694.3 / 574.7
HQVGA	240	160	0.038	1135.0 / 968.3 / 800.1		
QQVGA	160	120	0.019	1385.9 / 1192.2 / 989.5		
Max. × half	1936	608	1.177	359.4 / 198.2 / 196.7	200.1 / 101.7 / 101.2	101.7 / 51.4 / 51.4
Max. × min.	1936	16	0.031	2366.5 / 1516.8 / 1462.1	1594.0 / 904.1 / 889.8	915.5 / 498.6 / 498.6
Min. × max.	16	1216	0.019	196.4 / 162.5 / 132.2		
Min. × min.	16	16	256 P	3257.7 / 2989.1 / 2572.8		

<sup>1</sup> Mono8 or Bayer...8<sup>(2)</sup> at **SensorBitDepth** = 8-Bit<sup>(3)</sup> /  
 Mono10 or Bayer...10 at **SensorBitDepth** = 10-Bit  
 Mono12 or Bayer...12 at **SensorBitDepth** = 12-Bit

<sup>2</sup> The three dots... represent the colors of a Bayer pixel format, such as in Bayer**RG8**.

<sup>3</sup> The **SensorBitDepth** value must be set separately from **PixelFormat**.

See [Sensor ADC readout modes for maximum frame rates](#) on page 72 for details.

<sup>4</sup> Instead of 1440 × 900

If resolutions were not available due to increments, frame rates relate to the next available resolution.

Table 47: Alvim 1800 C-240m/c ROI frame rates



## Alvium 1800 C-291m/c

Red table border lines signal that **GeniCam for CSI-2 Access** is required.

Feature	Specification	
	1800 C-291m (monochrome)	1800 C-291c (color)
Sensor model	Sony IMX421	
Resolution	1944 (H) x 1472 (V); 2.9 MP	
Sensor type	CMOS	
Shutter type	Global shutter (GS)	
Sensor size	Type 2/3; 8.8 mm x 6.6 mm; 10.8 mm diagonal	
Pixel size	4.5 μm x 4.5 μm	
CRA	0 deg	
Sensor bit depth (ADC)	8-bit, 10-bit, 12-bit; Adaptive (10-bit, 12-bit)	
Sensor bit depth (ADC)	12-bit	
<b>Pixel formats, GeniCam for CSI-2 Access</b>		
Monochrome pixel formats	Mono8 (default), Mono10, Mono10p, Mono12, Mono12p	Mono8, Mono10, Mono10p, Mono12, Mono12p
YUV color pixel formats	Not applicable	YCbCr411_8_CbYYCrYY, YCbCr422_8_CbYCrY, YCbCr8_CbYCr
RGB color pixel formats	Not applicable	BGR8, RGB8 (default)
Raw color pixel formats	Not applicable	BayerRG8, BayerRG10, BayerRG10p, BayerRG12, BayerRG12p
<b>Pixel formats, other access modes</b>		
YUV color pixel formats	Not applicable	YUV422 8-bit (UYVY)
RGB color pixel formats	Default: RGB888 (RGB3)	
RAW pixel formats	RAW8 (GREY), RAW10 (Y10), RAW12 (Y12)	
Maximum frame rate	166 fps, using 4 lanes	
Maximum frame rate	116 fps, using 4 lanes	
Exposure time	17 μs to 10 s (4 lanes)	
Exposure modes	Timed, TriggerControlled, TriggerWidth	
Gain	0 dB to 48 dB; 0.1 dB increments	
Digital binning	Horizontal: 1 to 8 columns; Vertical: 1 to 8 rows	
Sensor binning (H x V)	2 x 2 ( <i>Sum, Average</i> )	Not applicable
Image buffer (RAM)	256 KByte	
Non-volatile memory (Flash)	1024 KByte	
GPIOs	2 programmable GPIOs As direct inputs (push-pull): 0 to 5.5 VDC As direct outputs (push-pull): 0 to 3.3 VDC at 12 mA	

Table 48: Alvium 1800 C-291m/c specifications (sheet 1 of 2)



Feature	Specification			
	<b>1800 C-291m/c</b>			
Power requirements	Power over MIPI CSI-2			
Power consumption (typical, at 5 VDC)	3.8 W			
Storage temperature	-20 °C to +85 °C ambient temperature			
<b>Operating temperature</b>	<b>Hardware option</b>	<b>Housing</b>	<b>Cooling area<sup>1</sup></b>	<b>Mainboard<sup>2</sup></b>
	Bare board <sup>3</sup>	Not applicable	-20 °C to +85 °C	-20 °C to +85 °C
	Open housing <sup>4</sup>	-20 °C to +65 °C		
Relative humidity	0% to 80% (non-condensing)			
Digital interface	MIPI CSI-2 D-PHY V1.1; 1, 2, or 4 lanes; maximum 1.051 Gbit/s per lane			
Camera controls	GenICam (GenICam for CSI-2 Access)			
	V4L2 controls (Video4Linux Access), Direct Register Access			
<sup>1</sup> See <a href="#">Mounting the heat sink</a> on page 256. <sup>2</sup> Output by <code>DeviceTemperature</code> <sup>3</sup> Ensure that the sensor is operated in the temperature range specified by the manufacturer. For any questions, please visit <a href="http://www.alliedvision.com/en/support">www.alliedvision.com/en/support</a> . <sup>4</sup> Temperature values must be observed for the housing <b>and</b> for the cooling area.				

Table 48: Alvium 1800 C-291m/c specifications (sheet 2 of 2)

## Absolute QE, spectral response

We intend to add diagrams in a future version of this document.

## Frame rates with Cropping

Values were calculated as defined in [Frame rates with ROI/Cropping](#) on page 71 and in [Operation for maximum frame rates](#) on page 73.

Frame rates at maximum bandwidth calculates for 1.051 Gbit/s per lane. To reach the maximum frame rate available for typical operation, the bandwidth for image traffic is at 4 lanes with 4.204 Gbit/s.

Image format	Width [pixels]	Height [pixels]	ROI area [MP]	Frame rate [fps] <sup>1</sup>		
				4-lane	2-lane	1-lane
				4.204 Gbit/s	2.102 Gbit/s	1.051 Gbit/s
Full resolution	1944	1472	2.862	166.3 / 85.8 / 85.5	85.6 / 43.3 / 43.2	43.3 / 21.8 / 21.8
Full HD	1920	1080	2.074	220.6 / 115.4 / 115.0	115.8 / 58.6 / 58.6	58.4 / 29.5 / 29.5
UXGA	1600	1200	1.920	201.7 / 125.4 / 125.1	125.3 / 63.8 / 63.7	63.5 / 32.0 / 32.1
WXGA+ <sup>4</sup>	1440	904	1.302	261.0 / 180.2 / 180.7	181.3 / 91.9 / 91.9	91.6 / 46.3 / 46.3
SXGA	1280	1024	1.311	234.3 / 180.8 / 164.5	181.5 / 92.2 / 92.1	92.1 / 46.4 / 46.6
HD 720	1280	720	0.922	320.3 / 247.8 / 225.5	248.8 / 126.9 / 126.9	126.8 / 64.0 / 64.3
XGA	1024	768	0.786	304.4 / 252.2 / 214.3	292.3 / 149.7 / 149.4	149.4 / 75.5 / 75.8
SVGA	800	600	0.480	379.9 / 315.1 / 268.5	379.9 / 237.5 / 237.4	236.3 / 120.7 / 120.9
VGA	640	480	0.307	462.0 / 383.1 / 326.9	462.0 / 358.8 / 326.9	358.5 / 182.6 / 183.3
HVGA	480	320	0.154	645.2 / 537.9 / 460.6		645.2 / 339.8 / 341.7
QVGA	320	240	0.077	810.9 / 678.2 / 582.6		810.9 / 633.7 / 582.6
HQVGA	240	160	0.038	1082.4 / 906.1 / 782.6		
QQVGA	160	120	0.019	1299.9 / 1097.4 / 952.1		
Max. × half	1944	736	1.431	308.7 / 161.3 / 160.5	161.1 / 82.0 / 81.8	81.9 / 41.4 / 41.5
Max. × min.	1944	16	0.031	1907.8 / 1153.8 / 1139.9	1169.7 / 655.3 / 659.4	649.0 / 351.6 / 359.7
Min. × max.	16	1472	0.024	170.9 / 141.2 / 119.8		
Min. × min.	16	16	256 P	2762.3 / 2399.8 / 2147.7		

<sup>1</sup> Mono8 or Bayer...8<sup>(2)</sup> at **SensorBitDepth** = 8-Bit<sup>(3)</sup> /  
 Mono10 or Bayer...10 at **SensorBitDepth** = 10-Bit  
 Mono12 or Bayer...12 at **SensorBitDepth** = 12-Bit

<sup>2</sup> The three dots... represent the colors of a Bayer pixel format, such as in Bayer**RG8**.

<sup>3</sup> The **SensorBitDepth** value must be set separately from **PixelFormat**.

See [Sensor ADC readout modes for maximum frame rates](#) on page 72 for details.

<sup>4</sup> Instead of 1440 × 900

If resolutions were not available due to increments, frame rates relate to the next available resolution.

Table 49: Alvim 1800 C-291m/c ROI frame rates



## Alvium 1800 C-319m/c

Red table border lines signal that **GenICam for CSI-2 Access** is required.

Feature	Specification	
	1800 C-319m (monochrome)	1800 C-319c (color)
Sensor model	Sony IMX265	
Resolution	2064 (H) × 1544 (V); 3.2 MP	
Sensor type	CMOS	
Shutter type	Global shutter (GS)	
Sensor size	Type 1/1.8; 7.1 mm × 5.3 mm; 8.9 mm diagonal	
Pixel size	3.45 μm × 3.45 μm	
CRA	0 deg	
Sensor bit depth (ADC)	12-bit	
<b>Pixel formats, GenICam for CSI-2 Access</b>		
Monochrome pixel formats	Mono8 (default), Mono10, Mono10p, Mono12, Mono12p	Mono8, Mono10, Mono10p, Mono12, Mono12p
YUV color pixel formats	Not applicable	YCbCr411_8_CbYYCrYY, YCbCr422_8_CbYCrY, YCbCr8_CbYCr
RGB color pixel formats	Not applicable	BGR8, RGB8 (default)
Raw color pixel formats	Not applicable	BayerRG8, BayerRG10, BayerRG10p, BayerRG12, BayerRG12p
<b>Pixel formats, other access modes</b>		
YUV color pixel formats	Not applicable	YUV422 8-bit (UYVY)
RGB color pixel formats	Default: RGB888 (RGB3)	
RAW pixel formats	RAW8 (GREY), RAW10 (Y10), RAW12 (Y12)	
Maximum frame rate	54 fps, using 2 to 4 lanes	
Maximum frame rate	54 fps, using 2 to 4 lanes	
Exposure time	26 μs to 10 s (2 lanes)	
Exposure modes	Timed, TriggerControlled, TriggerWidth	
Gain	0 dB to 48 dB; 0.1 dB increments	
Digital binning	Horizontal: 1 to 8 columns; Vertical: 1 to 8 rows	
Image buffer (RAM)	256 KByte	
Non-volatile memory (Flash)	1024 KByte	
GPIOs	2 programmable GPIOs As direct inputs (push-pull): 0 to 5.5 VDC As direct outputs (push-pull): 0 to 3.3 VDC at 12 mA	
Power requirements	Power over MIPI CSI-2	
Power consumption (typical, at 5 VDC)	1.9 W	

Table 50: Alvium 1800 C-319m/c specifications (sheet 1 of 2)

Feature	Specification			
	<b>1800 C-319m/c</b>			
Storage temperature	-20 °C to +85 °C ambient temperature			
<b>Operating temperature</b>	<b>Hardware option</b>	<b>Housing</b>	<b>Cooling area<sup>1</sup></b>	<b>Mainboard<sup>2</sup></b>
	Bare board <sup>3</sup>	Not applicable	-20 °C to +85 °C	-20 °C to +85 °C
	Open housing <sup>4</sup>	-20 °C to +65 °C		
Relative humidity	0% to 80% (non-condensing)			
Digital interface	MIPI CSI-2 D-PHY V1.1; 1, 2, or 4 lanes; maximum 1.051 Gbit/s per lane			
Camera controls	GenICam (GenICam for CSI-2 Access)			
	V4L2 controls (Video4Linux Access), Direct Register Access			
<sup>1</sup> See <a href="#">Mounting the heat sink</a> on page 256. <sup>2</sup> Output by <code>DeviceTemperature</code> <sup>3</sup> Ensure that the sensor is operated in the temperature range specified by the manufacturer. For any questions, please visit <a href="http://www.alliedvision.com/en/support">www.alliedvision.com/en/support</a> . <sup>4</sup> Temperature values must be observed for the housing <b>and</b> for the cooling area.				

Table 50: Alvim 1800 C-319m/c specifications (sheet 2 of 2)

### Absolute QE

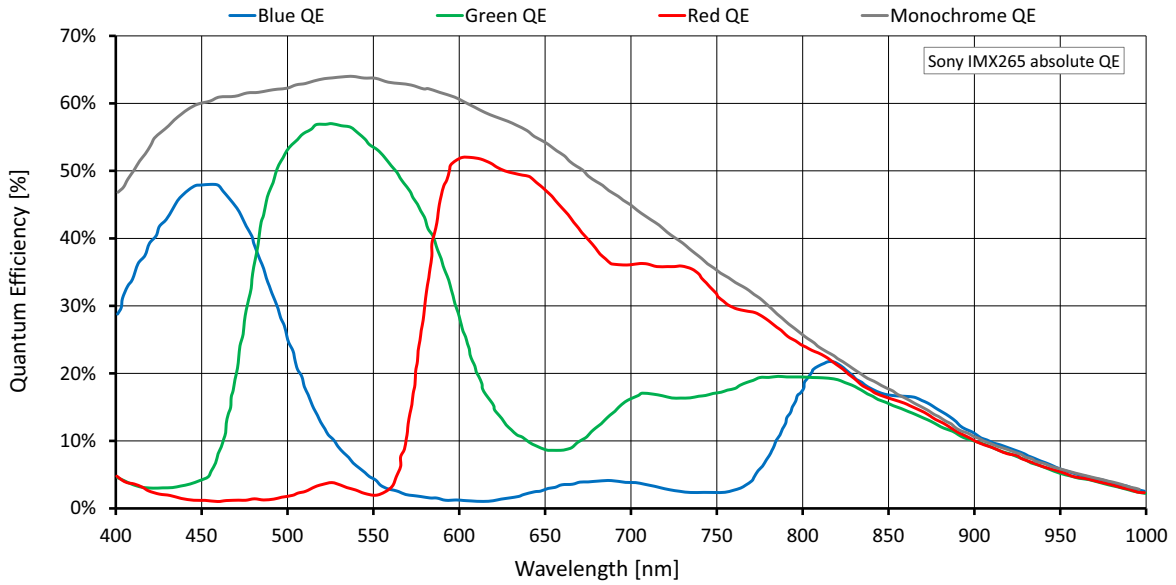

Figure 35: Alvium 1800 C-319m/c (Sony IMX265) absolute QE

### Spectral response

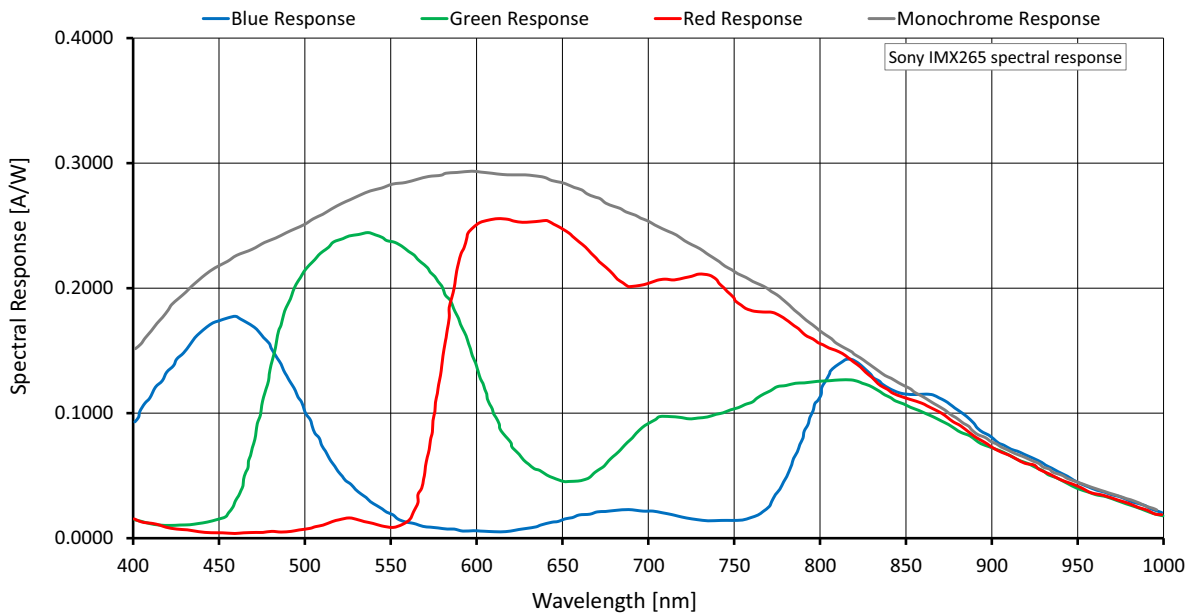

Figure 36: Alvium 1800 C-319m/c (Sony IMX265) spectral response

## Frame rates with Cropping

Values were calculated as defined in [Frame rates with ROI/Cropping](#) on page 71 and in [Operation for maximum frame rates](#) on page 73.

Frame rates at maximum bandwidth calculates for 1.051 Gbit/s per lane. To reach the maximum frame rate available for typical operation, the bandwidth for image traffic is at 2 lanes with 2.102 Gbit/s. Increasing the CSI-2 Lane Count value does not increase frame rates.

Image format	Width [pixels]	Height [pixels]	ROI area [MP]	Frame rate [fps] <sup>1</sup>		
				4-lane	2-lane	1-lane
				4.204 Gbit/s	2.102 Gbit/s	1.051 Gbit/s
Full resolution	2064	1544	3.187	54.1		39.5
QXGA	2048	1536	3.146	54.4		40.1
Full HD	1920	1080	2.074	76.1		59.9
UXGA	1600	1200	1.920	69.1		65.0
WXGA+ <sup>3</sup>	1440	904	1.302	90.5		
SXGA	1280	1024	1.311	80.5		
HD 720	1280	720	0.922	112.0		
XGA	1024	768	0.786	105.8		
SVGA	800	600	0.480	133.4		
VGA	640	480	0.307	163.8		
HVGA	480	320	0.154	235.5		
QVGA	320	240	0.077	301.5		
HQVGA	240	160	0.038	418.9		
QQVGA	160	120	0.019	518.7		
Max. × half <sup>4</sup>	2064	776	1.602	103.6		75.9
Max. × min.	2064	16	0.033	1075.9		835.0
Min. × max.	16	1544	0.025	54.7		
Min. × min.	16	16	256 P	1361.6		

<sup>1</sup> Mono8 or Mono10, Bayer...8 or Bayer...10<sup>(2)</sup>, or Mono12 or Bayer...12 at SensorBitDepth = 12-Bit

<sup>2</sup> The three dots... represent the colors of a Bayer pixel format, such as in BayerRG8.

<sup>3</sup> Instead of 1440 × 900 | <sup>4</sup> Instead of 2064 × 772

If resolutions were not available due to increments, frame rates relate to the next available resolution.

Table 51: Alvium 1800 C-319m/c ROI frame rates



## Alvium 1800 C-320 VSWIR (coming soon)

Red table border lines signal that **GenICam for CSI-2 Access** is required.

Feature	Specification
<b>1800 C-320 VSWIR (monochrome)</b>	
Sensor model	Sony IMX993
Resolution	2080(H) × 1544 (V); 3.2 MP
Sensor type	InGaAs
Shutter type	Global shutter (GS)
Sensor size	Type 1/1.8; 7.2 mm × 5.3 mm; 8.9 mm diagonal
Pixel size	3.45 μm × 3.45 μm
CRA	Tbd
Sensor bit depth (ADC)	8-bit, 10-bit, 12-bit; Adaptive (10-bit, 12-bit)
Sensor bit depth (ADC)	12-bit
<b>Pixel formats, GenICam for CSI-2 Access</b>	
Monochrome pixel formats	Mono8 (default), Mono10, Mono10p, Mono12, Mono12p
<b>Pixel formats, other access modes</b>	
RAW pixel formats	RAW8 (GREY), RAW10 (Y10), RAW12 (Y12)
Maximum frame rate	131 fps, using 4 lanes
Maximum frame rate	87 fps, using 4 lanes
Exposure time	24 μs to 10 s (4 lanes)
Exposure modes	Timed, TriggerControlled, TriggerWidth
Gain	0 dB to 48 dB; 0.1 dB increments
Digital binning	Horizontal: 1 to 8 columns; Vertical: 1 to 8 rows
Image buffer (RAM)	256 KByte
Non-volatile memory (Flash)	1024 KByte
GPIOs	2 programmable GPIOs As direct inputs (push-pull): 0 to 5.5 VDC As direct outputs (push-pull): 0 to 3.3 VDC at 12 mA
Power requirements	Power over MIPI CSI-2
Power consumption (typical, at 5 VDC)	Tbd

Table 52: Alvium 1800 C-320 VSWIR specifications (sheet 1 of 2)

Feature	Specification			
	<b>1800 C-320 VSWIR</b>			
Storage temperature	-20 °C to +85 °C ambient temperature			
<b>Operating temperature</b>	<b>Hardware option</b>	<b>Housing</b>	<b>Cooling area<sup>1</sup></b>	<b>Mainboard<sup>2</sup></b>
	Bare board <sup>3</sup>	Not applicable	-20 °C to +85 °C	-20 °C to +85 °C
	Open housing <sup>4</sup>	-20 °C to +65 °C		
Relative humidity	0% to 80% (non-condensing)			
Digital interface	MIPI CSI-2 D-PHY V1.1; 1, 2, or 4 lanes; maximum 1.051 Gbit/s per lane			
Camera controls	GenICam (GenICam for CSI-2 Access)			
	V4L2 controls (Video4Linux Access), Direct Register Access			
<sup>1</sup> See <a href="#">Mounting the heat sink</a> on page 256. <sup>2</sup> Output by <code>DeviceTemperature</code> <sup>3</sup> Ensure that the sensor is operated in the temperature range specified by the manufacturer. For any questions, please visit <a href="http://www.alliedvision.com/en/support">www.alliedvision.com/en/support</a> . <sup>4</sup> Temperature values must be observed for the housing <b>and</b> for the cooling area.				

Table 52: Alvium 1800 C-320 VSWIR specifications (sheet 2 of 2)

## Absolute QE, spectral response

We intend to add diagrams in a future version of this document.



## Frame rates with Cropping

Values were calculated as defined in [Frame rates with ROI/Cropping](#) on page 71 and in [Operation for maximum frame rates](#) on page 73.

Frame rates at maximum bandwidth calculates for 1.051 Gbit/s per lane. To reach the maximum frame rate available for typical operation, the bandwidth for image traffic is at 4 lanes with 4.204 Gbit/s.

Image format	Width [pixels]	Height [pixels]	ROI area [MP]	Frame rate [fps] <sup>1</sup>		
				4-lane	2-lane	1-lane
				4.204 Gbit/s	2.102 Gbit/s	1.051 Gbit/s
Full resolution	2080	1544	3.212	131.3 / 73.5 / 73.6	74.1 / 37.1 / 37.1	37.3 / 18.7 / 18.7
QXGA	2048	1536	3.146	132.0 / 75.2 / 74.7	75.4 / 37.9 / 37.9	38.0 / 19.1 / 19.0
Full HD	1920	1080	2.074	180.1 / 109.2 / 108.6	110.0 / 55.5 / 55.3	55.5 / 27.9 / 27.8
UXGA	1600	1200	1.920	165.1 / 119.4 / 110.2	119.6 / 60.6 / 60.4	60.6 / 30.5 / 30.4
WXGA <sup>3</sup>	1440	904	1.302	211.2 / 169.1 / 140.9	170.7 / 86.2 / 85.8	86.2 / 43.4 / 43.2
SXGA	1280	1024	1.311	190.4 / 156.1 / 127.0	172.0 / 87.0 / 86.7	87.3 / 43.8 / 43.8
HD 720	1280	720	0.922	255.8 / 209.8 / 170.7	231.3 / 117.3 / 116.8	117.7 / 59.1 / 59.2
XGA	1024	768	0.786	243.9 / 200.0 / 162.8	243.9 / 139.0 / 138.1	139.3 / 70.0 / 70.0
SVGA	800	600	0.480	299.4 / 245.9 / 199.9	299.4 / 216.7 / 199.9	216.8 / 110.0 / 109.6
VGA	640	480	0.307	357.6 / 293.7 / 238.8		323.3 / 163.3 / 162.8
HVGA	480	320	0.154	481.6 / 395.8 / 321.8		481.6 / 291.7 / 290.6
QVGA	320	240	0.077	584.9 / 480.9 / 391.0		
HQVGA	240	160	0.038	739.8 / 608.6 / 496.4		
QQVGA	160	120	0.019	857.5 / 705.8 / 573.8		
Max. × half <sup>4</sup>	2080	776	1.614	236.8 / 133.4 / 133.2	134.8 / 67.7 / 67.7	68.2 / 34.2 / 34.2
Max. × min.	2080	16	0.033	1155.0 / 687.7 / 671.7	713.4 / 372.3 / 367.1	380.4 / 194.6 / 192.5
Min. × max.	16	1544	0.025	134.3 / 110.2 / 89.6		
Min. × min.	16	16	0.000	1441.9 / 1189.9 / 967.4		

<sup>1</sup> Mono8 at **SensorBitDepth** = 8-Bit<sup>(2)</sup> /  
 Mono10 at **SensorBitDepth** = 10-Bit /  
 Mono12 at **SensorBitDepth** = 12-Bit

<sup>2</sup> The **SensorBitDepth** value must be set separately from **PixelFormat**.  
 See [Sensor ADC readout modes for maximum frame rates](#) on page 72 for details.

<sup>3</sup> Instead of 1440 × 900 | <sup>4</sup> Instead of 2080 × 772  
 If resolutions were not available due to increments, frame rates relate to the next available resolution.

Table 53: Alvium 1800 C-320 VSWIR ROI frame rates



## Alvium 1800 C-500m/c

Red table border lines signal that **GeniCam for CSI-2 Access** is required.

Feature	Specification	
	1800 C-500m (monochrome)	1800 C-500c (color)
Sensor model	ON Semiconductor AR0521SR	
Resolution	2592 (H) × 1944 (V); 5.0 MP	
Sensor type	CMOS	
Shutter type	Rolling shutter (RS)	
Sensor size	Type 1/2.5; 5.7 mm × 4.3 mm; 7.1 mm diagonal	
Pixel size	2.2 μm × 2.2 μm	
CRA	9 deg	
Sensor bit depth (ADC)	10-bit	
<b>Pixel formats, GeniCam for CSI-2 Access</b>		
Monochrome pixel formats	Mono8 (default), Mono10, Mono10p, Mono12, Mono12p	Mono8, Mono10, Mono10p, Mono12, Mono12p
YUV color pixel formats	Not applicable	YCbCr411_8_CbYYCrYY, YCbCr422_8_CbYCrY, YCbCr8_CbYCr
RGB color pixel formats		BGR8, RGB8 (default)
Raw color pixel formats	Not applicable	BayerGR8, BayerGR10, BayerGR10p, BayerGR12, BayerGR12p
<b>Pixel formats, other access formats</b>		
YUV color pixel formats	Not applicable	YUV422 8-bit (UYVY)
RGB color pixel formats	Default: RGB888 (RGB3)	
RAW pixel formats	RAW8 (GREY), RAW10 (Y10)	
Maximum frame rate	68 fps <sup>1</sup> , using 4 lanes	
Maximum frame rate	68 fps <sup>1</sup> , using 4 lanes	
Exposure time	8 μs to 10 s (4 lanes)	
Exposure modes	Timed	
Gain	0 dB to 24 dB; 0.1 dB increments	
Digital binning	Horizontal: 1 to 8 columns; Vertical: 1 to 8 rows	
Sensor binning (H × V)	2 × 1, 4 × 1 ( <i>Sum</i> )	
Image buffer (RAM)	256 KByte	
Non-volatile memory (Flash)	1024 KByte	
GPIOs	2 programmable GPIOs As direct inputs (push-pull): 0 to 5.5 VDC As direct outputs (push-pull): 0 to 3.3 VDC at 12 mA	
<sup>1</sup> In triggered mode: ~34 fps		

Table 54: Alvium 1800 C-500m/c specifications (sheet 1 of 2)

Feature	Specification			
	<b>1800 C-500m/c</b>			
Power requirements	Power over MIPI CSI-2			
Power consumption (typical, at 5 VDC)	1.9 W			
Storage temperature	-20 °C to +85 °C ambient temperature			
<b>Operating temperature</b>	<b>Hardware option</b>	<b>Housing</b>	<b>Cooling area<sup>2</sup></b>	<b>Mainboard<sup>3</sup></b>
	Bare board <sup>4</sup>	Not applicable	-20 °C to +85 °C	-20 °C to +85 °C
	Open housing <sup>5</sup>	-20 °C to +65 °C		
Relative humidity	0% to 80% (non-condensing)			
Digital interface	MIPI CSI-2 D-PHY V1.1; 1, 2, or 4 lanes; maximum 1.051 Gbit/s per lane			
Camera controls	GenICam (GenICam for CSI-2 Access)			
	V4L2 controls (Video4Linux Access), Direct Register Access			
<sup>2</sup> See <a href="#">Mounting the heat sink</a> on page 256.				
<sup>3</sup> Output by DeviceTemperature				
<sup>4</sup> Ensure that the sensor is operated in the temperature range specified by the manufacturer. For any questions, please visit <a href="http://www.alliedvision.com/en/support">www.alliedvision.com/en/support</a> .				
<sup>5</sup> Temperature values must be observed for the housing <b>and</b> for the cooling area.				

Table 54: Alvium 1800 C-500m/c specifications (sheet 2 of 2)

### Absolute QE

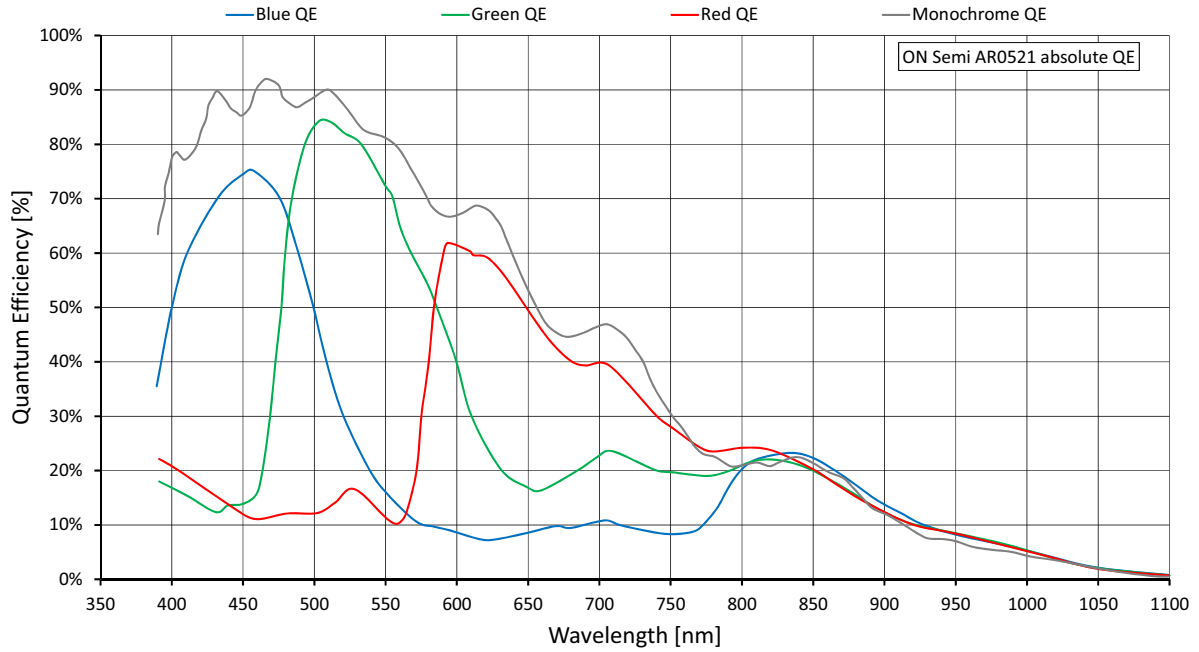

Figure 37: Alvim 1800 C-500m/c (ON Semi AR0521SR) absolute QE

### Spectral response

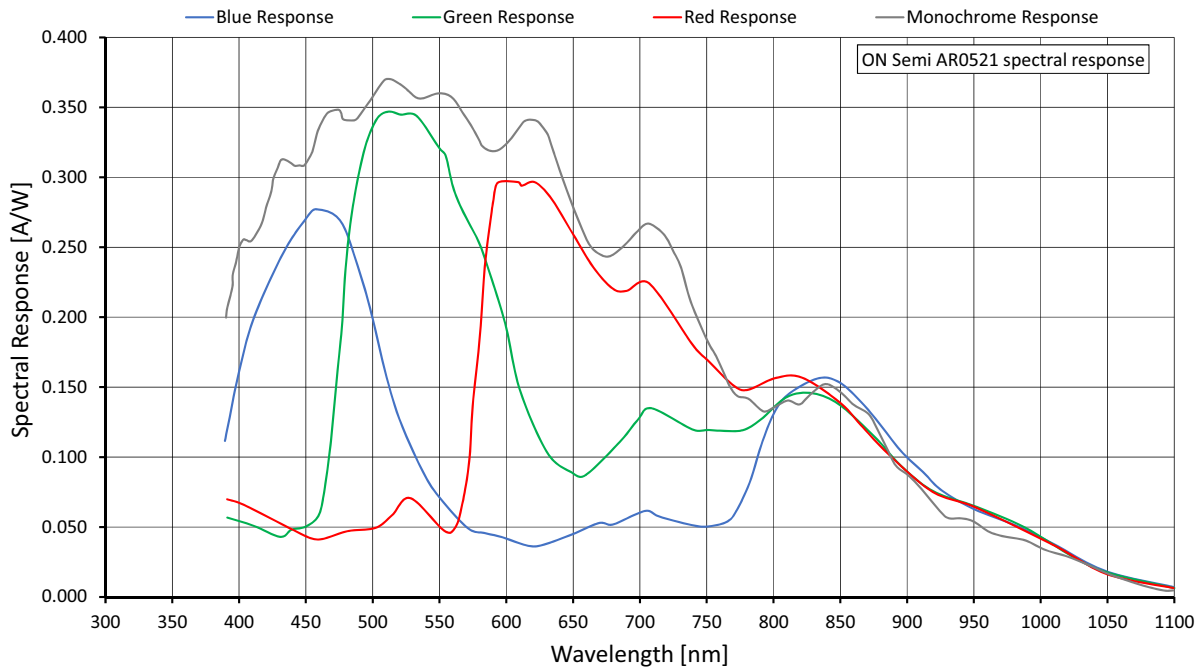

Figure 38: Alvim 1800 C-500m/c (ON Semi AR0521SR) spectral response

## Frame rates with Cropping

Values were calculated as defined in [Frame rates with ROI/Cropping](#) on page 71 and in [Operation for maximum frame rates](#) on page 73.

Frame rates at maximum bandwidth calculates for 1.051 Gbit/s per lane. To reach the maximum frame rate available for typical operation, the bandwidth for image traffic is at 4 lanes with 4.204 Gbit/s.

Shutter mode	User mode	Available frame rates
Rolling shutter (RS)	Freerun	Values in <a href="#">Table 56</a> below are reached.
Rolling shutter (RS)	Triggered	>50% of the values for in <a href="#">Table 56</a> below are reached.

Table 55: Frame rate behavior for different configurations

Image format	Width [pixels]	Height [pixels]	ROI area [MP]	Frame rate [fps] <sup>1</sup>		
				4-lane	2-lane	1-lane
				4.204 Gbit/s	2.102 Gbit/s	1.051 Gbit/s
Full resolution	2592	1944	5.039	68.1	50.8	25.5
WQHD	2560	1440	3.686	91.1	68.9	34.6
QXGA	2048	1536	3.146	85.8	80.8	40.6
Full HD	1920	1080	2.074	120.5		60.9
UXGA	1600	1200	1.920	109.1		66.0
WXGA+ <sup>3</sup>	1440	904	1.302	143.2		96.3
SXGA	1280	1024	1.311	127.2		96.2
HD 720	1280	720	0.922	177.7		134.5
XGA	1024	768	0.786	167.7		158.1
SVGA	800	600	0.480	212.1		
VGA	640	480	0.307	261.3		
HVGA	480	320	0.154	378.2		
QVGA	320	240	0.077	488.0		
HQVGA	240	160	0.038	684.2		
QQVGA	160	120	0.019	856.3		
Max. × half <sup>4</sup>	2592	976	2.530	132.0	98.8	49.7
Max. × min.	2592	16	0.041	1917.2	1535.3	858.9
Min. × max.	16	1944	0.031	68.6		
Min. × min.	16	16	256 P	2474.6		

<sup>1</sup> Mono8 or Mono10, Bayer...8 or Bayer...10<sup>(2)</sup>, or Mono12 or Bayer...12 at **SensorBitDepth** = 10-Bit

<sup>2</sup> The three dots... represent the colors of a Bayer pixel format, such as in Bayer**RG8**.

<sup>3</sup> Instead of 1440 × 900 | <sup>4</sup> Instead of 2592 × 972

If resolutions were not available due to increments, frame rates relate to the next available resolution.

Table 56: Alvim 1800 C-500m/c ROI frame rates



## Alvium 1800 C-507m/c

Red table border lines signal that **GenICam for CSI-2 Access** is required.

Feature	Specification	
	1800 C-507m (monochrome)	1800 C-507c (color)
Sensor model	Sony IMX264	
Resolution	2464 (H) × 2056 (V); 5.1 MP	
Sensor type	CMOS	
Shutter type	Global shutter (GS)	
Sensor size	Type 2/3; 8.5 mm × 7.1 mm; 11.1 mm diagonal	
Pixel size	3.45 μm × 3.45 μm	
CRA	0 deg	
ADC bit depth	12-bit	
<b>Pixel formats, GenICam for CSI-2 Access</b>		
Monochrome pixel formats	Mono8 (default), Mono10, Mono10p, Mono12, Mono12p	Mono8, Mono10, Mono10p, Mono12, Mono12p
YUV color pixel formats	Not applicable	YCbCr411_8_CbYYCrYY, YCbCr422_8_CbYCrY, YCbCr8_CbYCr
RGB color pixel formats	Not applicable	BGR8, RGB8 (default)
Raw color pixel formats	Not applicable	BayerRG8, BayerRG10, BayerRG10p, BayerRG12, BayerRG12p
<b>Pixel formats, other access modes</b>		
YUV color pixel formats	Not applicable	YUV422 8-bit (UYVY)
RGB color pixel formats	Default: RGB888 (RGB3)	
RAW pixel formats	RAW8 (GREY), RAW10 (Y10), RAW12 (Y12)	
Maximum frame rate	34 fps, using 2 to 4 lanes	
Maximum frame rate	34 fps, using 2 to 4 lanes	
Exposure time	28 μs to 10 s (2 lanes)	
Exposure modes	Timed, TriggerControlled, TriggerWidth	
Gain	0 dB to 48 dB; 0.1 dB increments	
Digital binning	Horizontal: 1 to 8 columns; Vertical: 1 to 8 rows	
Image buffer (RAM)	256 KByte	
Non-volatile memory (Flash)	1024 KByte	
GPIOs	2 programmable GPIOs As direct inputs (push-pull): 0 to 5.5 VDC As direct outputs (push-pull): 0 to 3.3 VDC at 12 mA	
Power requirements	Power over MIPI CSI-2	

Table 57: Alvium 1800 C-507m/c specifications (sheet 1 of 2)

Feature	Specification			
	<b>1800 C-507m/c</b>			
Power consumption (typical, at 5 VDC)	1.9 W			
Storage temperature	-20 °C to +85 °C ambient temperature			
<b>Operating temperature</b>	<b>Hardware option</b>	<b>Housing</b>	<b>Cooling area<sup>1</sup></b>	<b>Mainboard<sup>2</sup></b>
	Bare board <sup>3</sup>	Not applicable	-20 °C to +85 °C	-20 °C to +85 °C
	Open housing <sup>4</sup>	-20 °C to +65 °C		
Relative humidity	0% to 80% (non-condensing)			
Digital interface	MIPI CSI-2 D-PHY V1.1; 1, 2, or 4 lanes; maximum 1.051 Gbit/s per lane			
Camera controls	GenICam (GenICam for CSI-2 Access)			
	V4L2 controls (Video4Linux Access), Direct Register Access			
<sup>1</sup> See <a href="#">Mounting the heat sink</a> on page 256. <sup>2</sup> Output by <code>DeviceTemperature</code> <sup>3</sup> Ensure that the sensor is operated in the temperature range specified by the manufacturer. For any questions, please visit <a href="http://www.alliedvision.com/en/support">www.alliedvision.com/en/support</a> . <sup>4</sup> Temperature values must be observed for the housing <b>and</b> for the cooling area.				

Table 57: Alvium 1800 C-507m/c specifications (sheet 2 of 2)

### Absolute QE

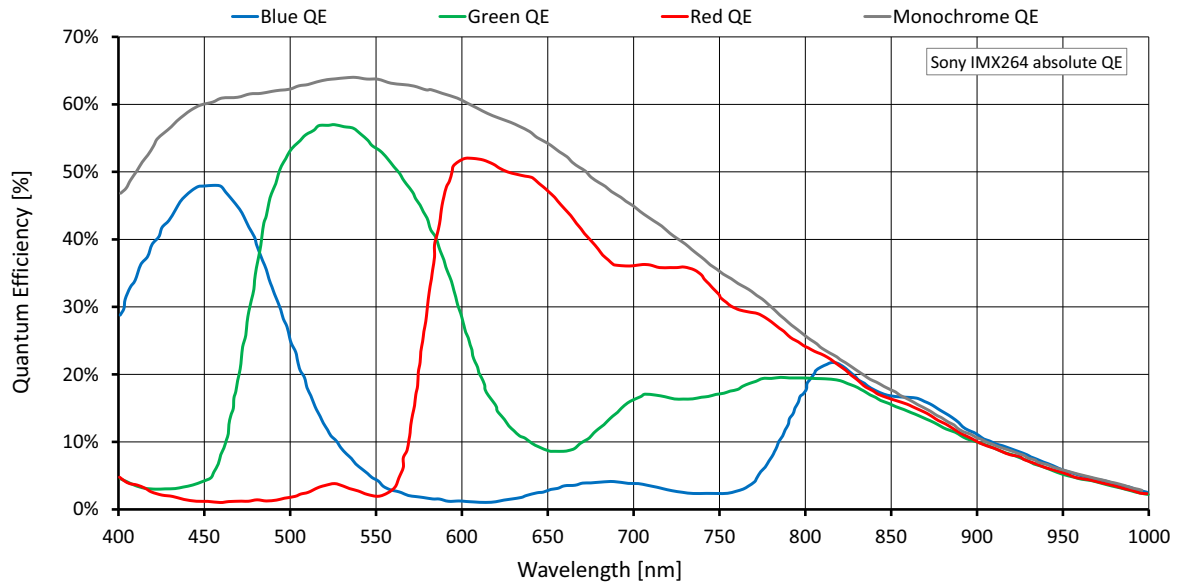

Figure 39: Alvium 1800 C-507m/c (Sony IMX264) absolute QE

### Spectral response

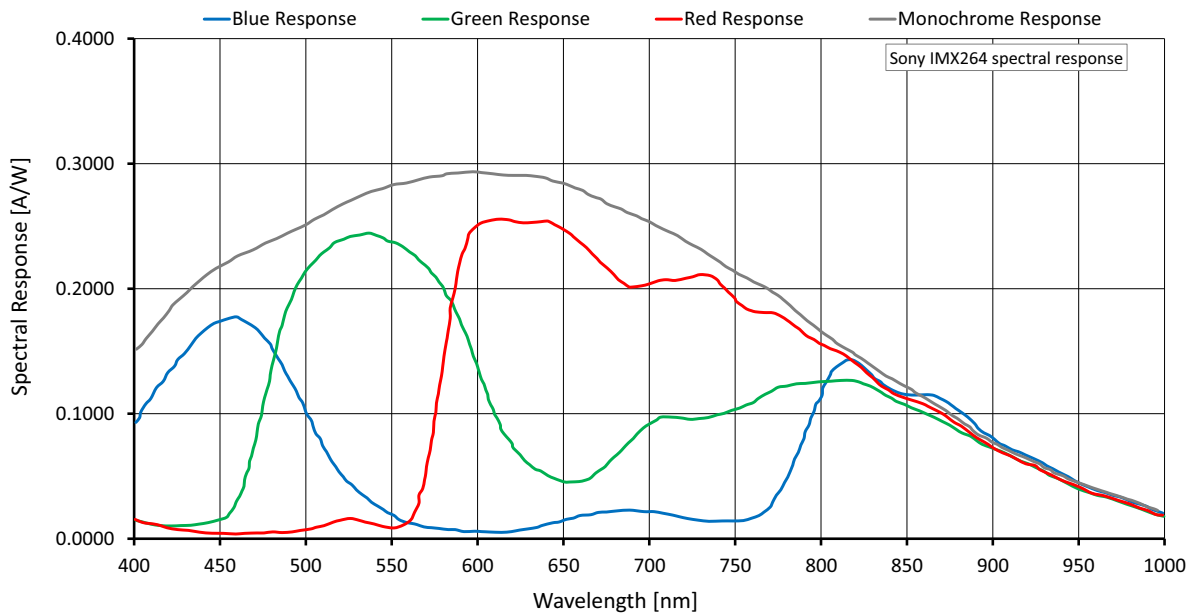

Figure 40: Alvium 1800 C-507m/c (Sony IMX264) spectral response



## Frame rates with Cropping

Values were calculated as defined in [Frame rates with ROI/Cropping](#) on page 71 and in [Operation for maximum frame rates](#) on page 73.

Frame rates at maximum bandwidth calculates for 1.051 Gbit/s per lane. To reach the maximum frame rate available for typical operation, the bandwidth for image traffic is at 2 lanes with 2.102 Gbit/s. Increasing the CSI-2 Lane Count value does not increase frame rates.

Image format	Width [pixels]	Height [pixels]	ROI area [MP]	Frame rate [fps] <sup>1</sup>		
				4-lane	2-lane	1-lane
				4.204 Gbit/s	2.102 Gbit/s	1.051 Gbit/s
Full resolution	2464	2056	5.066	34.9		25.1
QXGA	2048	1536	3.146	46.3		40.1
Full HD	1920	1080	2.074	64.9		59.9
UXGA	1600	1200	1.920		58.9	
WXGA+ <sup>3</sup>	1440	904	1.302		77.1	
SXGA	1280	1024	1.311		68.6	
HD 720	1280	720	0.922		95.4	
XGA	1024	768	0.786		90.1	
SVGA	800	600	0.480		113.6	
VGA	640	480	0.307		139.5	
HVGA	480	320	0.154		200.2	
QVGA	320	240	0.077		257.3	
HQVGA	240	160	0.038		356.2	
QQVGA	160	120	0.019		441.0	
Max. × half <sup>4</sup>	2464	1032	2.543	67.5		48.6
Max. × min.	2464	16	0.039	914.8		698.8
Min. × max.	16	2056	0.033		35.2	
Min. × min.	16	16	256 P		1157.8	

<sup>1</sup> Mono8 or Mono10, Bayer...8 or Bayer...10<sup>(2)</sup>, or Mono12 or Bayer...12 at SensorBitDepth = 12-Bit

<sup>2</sup> The three dots... represent the colors of a Bayer pixel format, such as in BayerRG8.

<sup>3</sup> Instead of 1440 × 900 | <sup>4</sup> Instead of 2464 × 1028

If resolutions were not available due to increments, frame rates relate to the next available resolution.

Table 58: Alvium 1800 C-507m/c ROI frame rates



## Alvium 1800 C-507m/c Pol (coming soon)

Red table border lines signal that **GenICam for CSI-2 Access** is required.



### Please observe

For first series models, pixel processing has not been adjusted to enable the complete functionality available with non-polarizer models:

- Only raw pixel formats are supported, but no formats for polarizer sensors.
- Features based on pixel processing are available but cannot be used to generate a proper output. For example, color processing, binning, convolution filter, DPC, or FPNC are not supported.

Feature	Specification	
	1800 C-507m Pol (monochrome)	1800 C-507c Pol (color)
Sensor model	Sony IMX264MZR	Sony IMX264MYR
Resolution	2464 (H) × 2056 (V); 5.1 MP	
Sensor type	CMOS	
Shutter type	Global shutter (GS)	
Sensor size	Type 2/3; 8.5 mm × 7.1 mm; 11.1 mm diagonal	
Pixel size	3.45 μm × 3.45 μm	
CRA	0 deg	
ADC bit depth	12-bit	
<b>Pixel formats, GenICam for CSI-2 Access</b>		
Monochrome pixel formats	Mono8 (default), Mono10, Mono10p, Mono12, Mono12p	Not applicable
Raw color pixel formats	Not applicable	BayerRG8, BayerRG10, BayerRG10p, BayerRG12, BayerRG12p
<b>Pixel formats, other access modes</b>		
RAW pixel formats	RAW8 (GREY), RAW10 (Y10), RAW12 (Y12)	
Maximum frame rate	34 fps, using 2 to 4 lanes	
Maximum frame rate	34 fps, using 2 to 4 lanes	
Exposure time	28 μs to 10 s (2 lanes)	
Exposure modes	Timed, TriggerControlled, TriggerWidth	
Gain	0 dB to 48 dB; 0.1 dB increments	
Image buffer (RAM)	256 KByte	
Non-volatile memory (Flash)	1024 KByte	
GPIOs	2 programmable GPIOs As direct inputs (push-pull): 0 to 5.5 VDC As direct outputs (push-pull): 0 to 3.3 VDC at 12 mA	

Table 59: Alvium 1800 C-507m/c Pol specifications (sheet 1 of 2)

Feature	Specification			
	<b>1800 C-507m/c</b>			
Power requirements	Power over MIPI CSI-2			
Power consumption (typical, at 5 VDC)	1.9 W			
Storage temperature	-20 °C to +85 °C ambient temperature			
<b>Operating temperature</b>	<b>Hardware option</b>	<b>Housing</b>	<b>Cooling area<sup>1</sup></b>	<b>Mainboard<sup>2</sup></b>
	Bare board <sup>3</sup>	Not applicable	-20 °C to +85 °C	-20 °C to +85 °C
	Open housing <sup>4</sup>	-20 °C to +65 °C		
Relative humidity	0% to 80% (non-condensing)			
Digital interface	MIPI CSI-2 D-PHY V1.1; 1, 2, or 4 lanes; maximum 1.051 Gbit/s per lane			
Camera controls	GenICam (GenICam for CSI-2 Access)			
	V4L2 controls (Video4Linux Access), Direct Register Access			
<sup>1</sup> See <a href="#">Mounting the heat sink</a> on page 256. <sup>2</sup> Output by <code>DeviceTemperature</code> <sup>3</sup> Ensure that the sensor is operated in the temperature range specified by the manufacturer. For any questions, please visit <a href="http://www.alliedvision.com/en/support">www.alliedvision.com/en/support</a> . <sup>4</sup> Temperature values must be observed for the housing <b>and</b> for the cooling area.				

Table 59: Alvium 1800 C-507m/c Pol specifications (sheet 2 of 2)

## Absolute QE, spectral response

We intend to add diagrams in a future version of this document.

## Frame rates with Cropping

Values were calculated as defined in [Frame rates with ROI/Cropping](#) on page 71 and in [Operation for maximum frame rates](#) on page 73.

Frame rates at maximum bandwidth calculates for 1.051 Gbit/s per lane. To reach the maximum frame rate available for typical operation, the bandwidth for image traffic is at 2 lanes with 2.102 Gbit/s. Increasing the CSI-2 Lane Count value does not increase frame rates.

Image format	Width [pixels]	Height [pixels]	ROI area [MP]	Frame rate [fps] <sup>1</sup>		
				4-lane	2-lane	1-lane
				4.204 Gbit/s	2.102 Gbit/s	1.051 Gbit/s
Full resolution	2464	2056	5.066	34.9		25.1
QXGA	2048	1536	3.146	46.3		40.1
Full HD	1920	1080	2.074	64.9		59.9
UXGA	1600	1200	1.920	58.9		
WXGA+ <sup>4</sup>	1440	904	1.302	77.1		
SXGA	1280	1024	1.311	68.6		
HD 720	1280	720	0.922	95.4		
XGA	1024	768	0.786	90.1		
SVGA	800	600	0.480	113.6		
VGA	640	480	0.307	139.5		
HVGA	480	320	0.154	200.2		
QVGA	320	240	0.077	257.3		
HQVGA	240	160	0.038	356.2		
QQVGA	160	120	0.019	441.0		
Max. × half <sup>5</sup>	2464	1032	2.543	67.5		48.6
Max. × min.	2464	16	0.039	914.8		698.8
Min. × max.	16	2056	0.033	35.2		
Min. × min.	16	16	256 P	1157.8		

<sup>1</sup> Mono8 or Mono10, Bayer...8 or Bayer...10<sup>(2)</sup>, or Mono12 or Bayer...12 at SensorBitDepth = 12-Bit

<sup>2</sup> The three dots... represent the colors of a Bayer pixel format, such as in BayerRG8.

<sup>3</sup> The SensorBitDepth value must be set separately from PixelFormat.

See [Sensor ADC readout modes for maximum frame rates](#) on page 72 for details.

<sup>4</sup> Instead of 1440 × 900 | <sup>5</sup> Instead of 2464 × 1028

If resolutions were not available due to increments, frame rates relate to the next available resolution.

Table 60: Alvium 1800 C-507m/c Pol ROI frame rates



## Alvium 1800 C-508m/c

Red table border lines signal that **GenICam for CSI-2 Access** is required.

Feature	Specification	
	1800 C-508m (monochrome)	1800 C-508c (color)
Sensor model	Sony IMX250	
Resolution	2464 (H) x 2056 (V); 5.1 MP	
Sensor type	CMOS	
Shutter type	Global shutter (GS)	
Sensor size	Type 2/3; 8.5 mm x 7.1 mm; 11.1 mm diagonal	
Pixel size	3.45 μm x 3.45 μm	
CRA	0 deg	
Sensor bit depth (ADC)	8-bit, 10-bit, 12-bit; Adaptive (10-bit, 12-bit)	
Sensor bit depth (ADC)	12-bit	
<b>Pixel formats, GenICam for CSI-2 Access</b>		
Monochrome pixel formats	Mono8 (default), Mono10, Mono10p, Mono12, Mono12p	Mono8, Mono10, Mono10p, Mono12, Mono12p
YUV color pixel formats	Not applicable	YCbCr411_8_CbYYCrYY, YCbCr422_8_CbYCrY, YCbCr8_CbYCr
RGB color pixel formats	Not applicable	BGR8, RGB8 (default)
Raw color pixel formats	Not applicable	BayerRG8, BayerRG10, BayerRG10p, BayerRG12, BayerRG12p
<b>Pixel formats, other access modes</b>		
YUV color pixel formats	Not applicable	YUV422 8-bit (UYVY)
RGB color pixel formats	Default: RGB888 (RGB3)	
RAW pixel formats	RAW8 (GREY), RAW10 (Y10), RAW12 (Y12)	
Maximum frame rate	95 fps, using 4 lanes	
Maximum frame rate	65 fps, using 4 lanes	
Exposure time	19 μs to 10 s (4 lanes)	
Exposure modes	Timed, TriggerControlled, TriggerWidth	
Gain	0 dB to 48 dB; 0.1 dB increments	
Digital binning	Horizontal: 1 to 8 columns; Vertical: 1 to 8 rows	
Sensor binning (H x V)	1 x 2 ( <i>Sum</i> )	Not applicable
Image buffer (RAM)	256 KByte	
Non-volatile memory (Flash)	1024 KByte	
GPIOs	2 programmable GPIOs As direct inputs (push-pull): 0 to 5.5 VDC As direct outputs (push-pull): 0 to 3.3 VDC at 12 mA	
Power requirements	Power over MIPI CSI-2	

Table 61: Alvium 1800 C-508m/c specifications (sheet 1 of 2)

Feature	Specification			
	<b>1800 C-508m/C</b>			
Power consumption (typical, at 5 VDC)	2.8 W			
Storage temperature	-20 °C to +85 °C ambient temperature			
<b>Operating temperature</b>	<b>Hardware option</b>	<b>Housing</b>	<b>Cooling area<sup>1</sup></b>	<b>Mainboard<sup>2</sup></b>
	Bare board <sup>3</sup>	Not applicable	-20 °C to +85 °C	-20 °C to +85 °C
	Open housing <sup>4</sup>	-20 °C to +65 °C		
Relative humidity	0% to 80% (non-condensing)			
Digital interface	MIPI CSI-2 D-PHY V1.1; 1, 2, or 4 lanes; maximum 1.051 Gbit/s per lane			
Camera controls	GenICam (GenICam for CSI-2 Access)			
	V4L2 controls (Video4Linux Access), Direct Register Access			
<sup>1</sup> See <a href="#">Mounting the heat sink</a> on page 256. <sup>2</sup> Output by <code>DeviceTemperature</code> <sup>3</sup> Ensure that the sensor is operated in the temperature range specified by the manufacturer. For any questions, please visit <a href="http://www.alliedvision.com/en/support">www.alliedvision.com/en/support</a> . <sup>4</sup> Temperature values must be observed for the housing <b>and</b> for the cooling area.				

Table 61: Alvium 1800 C-508m/c specifications (sheet 2 of 2)

### Absolute QE

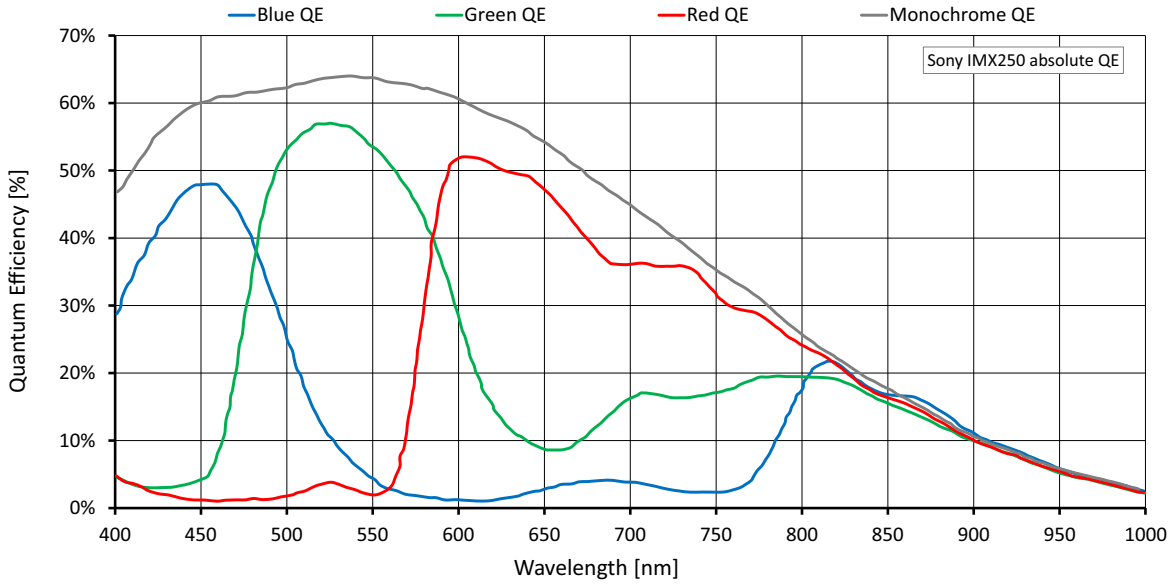

Figure 41: Alvium 1800 C-508m/c (Sony IMX250) absolute QE

### Spectral response

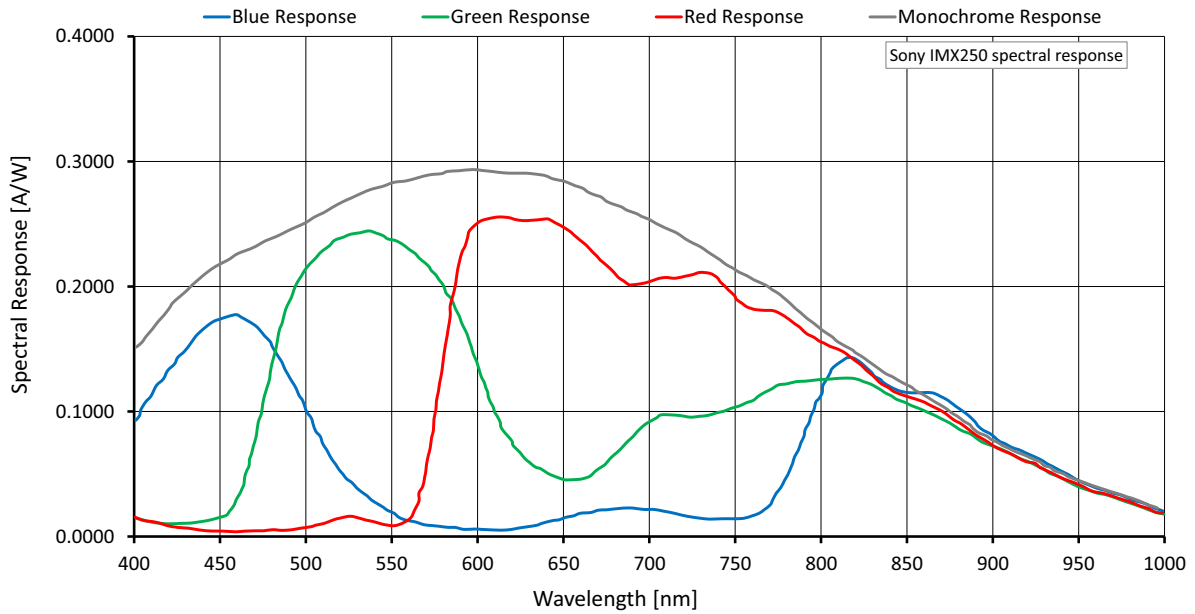

Figure 42: Alvium 1800 C-508m/c (Sony IMX250) spectral response

## Frame rates with Cropping

Values were calculated as defined in [Frame rates with ROI/Cropping](#) on page 71 and in [Operation for maximum frame rates](#) on page 73.

Frame rates at maximum bandwidth calculates for 1.051 Gbit/s per lane. To reach the maximum frame rate available for typical operation, the bandwidth for image traffic is at 4 lanes with 4.204 Gbit/s.

Image format	Width [pixels]	Height [pixels]	ROI area [MP]	Frame rate [fps] <sup>1</sup>		
				4-lane	2-lane	1-lane
				4.204 Gbit/s	2.102 Gbit/s	1.051 Gbit/s
Full resolution	2464	2056	5.066	95.1 / 49.8 / 49.5	49.9 / 25.1 / 25.1	25.2 / 12.6 / 12.6
QXGA	2048	1536	3.146	126.1 / 79.5 / 79.0	79.8 / 40.1 / 40.1	40.2 / 20.2 / 20.1
Full HD	1920	1080	2.074	175.8 / 118.0 / 117.2	118.8 / 60.0 / 59.8	60.0 / 30.2 / 30.1
UXGA	1600	1200	1.920	160.0 / 128.0 / 111.5	128.3 / 65.1 / 64.8	65.0 / 32.7 / 32.6
WXGA+ <sup>4</sup>	1440	904	1.302	209.0 / 170.8 / 145.6	186.8 / 94.4 / 94.0	94.5 / 47.5 / 47.4
SXGA	1280	1024	1.311	186.5 / 152.5 / 129.9	186.5 / 94.4 / 94.0	94.7 / 47.5 / 47.5
HD 720	1280	720	0.922	258.2 / 211.2 / 179.8	258.2 / 131.1 / 130.4	131.7 / 66.2 / 66.2
XGA	1024	768	0.786	244.9 / 200.1 / 170.6	244.9 / 154.4 / 153.3	154.8 / 77.9 / 77.8
SVGA	800	600	0.480	308.6 / 252.1 / 214.9	308.6 / 246.9 / 214.9	247.1 / 125.5 / 124.9
VGA	640	480	0.307	378.4 / 309.6 / 263.9		378.4 / 191.4 / 190.8
HVGA	480	320	0.154	541.1 / 443.8 / 378.3		541.1 / 363.3 / 361.7
QVGA	320	240	0.077	686.8 / 569.5 / 483.8		
HQVGA	240	160	0.038	940.0 / 787.0 / 667.8		
QQVGA	160	120	0.019	1152.5 / 970.1 / 822.2		
Max. × half <sup>5</sup>	2464	1032	2.543	182.0 / 95.8 / 95.1	96.3 / 48.7 / 48.5	48.8 / 24.6 / 24.5
Max. × min.	2464	16	0.039	1942.7 / 1165.6 / 1101.8	1247.9 / 691.2 / 663.9	718.8 / 380.9 / 370.4
Min. × max.	16	2056	0.033	96.5 / 79.2 / 67.4		
Min. × min.	16	16	256 P	2794.3 / 2453.7 / 2061.5		

<sup>1</sup> Mono8 or Bayer...8<sup>(2)</sup> at **SensorBitDepth** = 8-Bit<sup>(3)</sup> /  
 Mono10 or Bayer...10 at **SensorBitDepth** = 10-Bit  
 Mono12 or Bayer...12 at **SensorBitDepth** = 12-Bit

<sup>2</sup> The three dots... represent the colors of a Bayer pixel format, such as in Bayer**RG8**.

<sup>3</sup> The **SensorBitDepth** value must be set separately from **PixelFormat**.

See [Sensor ADC readout modes for maximum frame rates](#) on page 72 for details.

<sup>4</sup> Instead of 1440 × 900 | <sup>5</sup> Instead of 2464 × 1028

If resolutions were not available due to increments, frame rates relate to the next available resolution.

Table 62: Alvium 1800 C-508m/c ROI frame rates





## Alvium 1800 C-508m/c Pol (coming soon)

Red table boarder lines signal that **GenICam for CSI-2 Access** is required.



### Please observe

For first series models, pixel processing has not been adjusted to enable the complete functionality available with non-polarizer models:

- Only raw pixel formats are supported, but no formats for polarizer sensors.
- Features based on pixel processing are available but cannot be used to generate a proper output. For example, color processing, binning, convolution filter, DPC, or FPNC are not supported.

Feature	Specification	
	1800 U-508m Pol (monochrome)	1800 U-508c Pol (color)
Sensor model	Sony IMX250MZR	Sony IMX250MYR
Resolution	2464 (H) x 2056 (V); 5.1 MP	
Sensor type	CMOS	
Shutter type	Global shutter (GS)	
Sensor size	Type 2/3; 8.5 mm x 7.1 mm; 11.1 mm diagonal	
Pixel size	3.45 $\mu\text{m}$ x 3.45 $\mu\text{m}$	
CRA	0 deg	
Sensor bit depth (ADC)	8-bit, 10-bit, 12-bit; Adaptive (10-bit, 12-bit)	
Sensor bit depth (ADC)	12-bit	
<b>Pixel formats, GenICam for CSI-2 Access</b>		
Monochrome pixel formats	Mono8 (default), Mono10, Mono10p, Mono12, Mono12p	Not applicable
Raw color pixel formats	Not applicable	BayerRG8, BayerRG10, BayerRG10p, BayerRG12, BayerRG12p
<b>Pixel formats, other access modes</b>		
RAW pixel formats	RAW8 (GREY), RAW10 (Y10), RAW12 (Y12)	
Maximum frame rate	95 fps, using 4 lanes	
Maximum frame rate	65 fps, using 4 lanes	
Exposure time	19 $\mu\text{s}$ to 10 s (4 lanes)	
Exposure modes	Timed, TriggerControlled, TriggerWidth	
Gain	0 dB to 48 dB; 0.1 dB increments	
Image buffer (RAM)	256 KByte	
Non-volatile memory (Flash)	1024 KByte	
GPIOs	2 programmable GPIOs As direct inputs (push-pull): 0 to 5.5 VDC As direct outputs (push-pull): 0 to 3.3 VDC at 12 mA	

Table 63: Alvium 1800 C-508m/c Pol specifications (sheet 1 of 2)

Feature	Specification			
	<b>1800 C-508m/C</b>			
Power requirements	Power over MIPI CSI-2			
Power consumption (typical, at 5 VDC)	2.8 W			
Storage temperature	-20 °C to +85 °C ambient temperature			
<b>Operating temperature</b>	<b>Hardware option</b>	<b>Housing</b>	<b>Cooling area<sup>1</sup></b>	<b>Mainboard<sup>2</sup></b>
	Bare board <sup>3</sup>	Not applicable	-20 °C to +85 °C	-20 °C to +85 °C
	Open housing <sup>4</sup>	-20 °C to +65 °C		
Relative humidity	0% to 80% (non-condensing)			
Digital interface	MIPI CSI-2 D-PHY V1.1; 1, 2, or 4 lanes; maximum 1.051 Gbit/s per lane			
Camera controls	GenICam (GenICam for CSI-2 Access)			
	V4L2 controls (Video4Linux Access), Direct Register Access			
<sup>1</sup> See <a href="#">Mounting the heat sink</a> on page 256.				
<sup>2</sup> Output by <code>DeviceTemperature</code>				
<sup>3</sup> Ensure that the sensor is operated in the temperature range specified by the manufacturer. For any questions, please visit <a href="http://www.alliedvision.com/en/support">www.alliedvision.com/en/support</a> .				
<sup>4</sup> Temperature values must be observed for the housing <b>and</b> for the cooling area.				

Table 63: Alvium 1800 C-508m/c Pol specifications (sheet 2 of 2)

## Absolute QE, spectral response

We intend to add diagrams in a future version of this document.

## Frame rates with Cropping

Values were calculated as defined in [Frame rates with ROI/Cropping](#) on page 71 and in [Operation for maximum frame rates](#) on page 73.

Frame rates at maximum bandwidth calculates for 1.051 Gbit/s per lane. To reach the maximum frame rate available for typical operation, the bandwidth for image traffic is at 4 lanes with 4.204 Gbit/s.

Image format	Width [pixels]	Height [pixels]	ROI area [MP]	Frame rate [fps] <sup>1</sup>		
				4-lane	2-lane	1-lane
				4.204 Gbit/s	2.102 Gbit/s	1.051 Gbit/s
Full resolution	2464	2056	5.066	95.1 / 49.8 / 49.5	49.9 / 25.1 / 25.1	25.2 / 12.6 / 12.6
QXGA	2048	1536	3.146	126.1 / 79.5 / 79.0	79.8 / 40.1 / 40.1	40.2 / 20.2 / 20.1
Full HD	1920	1080	2.074	175.8 / 118.0 / 117.2	118.8 / 60.0 / 59.8	60.0 / 30.2 / 30.1
UXGA	1600	1200	1.920	160.0 / 128.0 / 111.5	128.3 / 65.1 / 64.8	65.0 / 32.7 / 32.6
WXGA+ <sup>4</sup>	1440	904	1.302	209.0 / 170.8 / 145.6	186.8 / 94.4 / 94.0	94.5 / 47.5 / 47.4
SXGA	1280	1024	1.311	186.5 / 152.5 / 129.9	186.5 / 94.4 / 94.0	94.7 / 47.5 / 47.5
HD 720	1280	720	0.922	258.2 / 211.2 / 179.8	258.2 / 131.1 / 130.4	131.7 / 66.2 / 66.2
XGA	1024	768	0.786	244.9 / 200.1 / 170.6	244.9 / 154.4 / 153.3	154.8 / 77.9 / 77.8
SVGA	800	600	0.480	308.6 / 252.1 / 214.9	308.6 / 246.9 / 214.9	247.1 / 125.5 / 124.9
VGA	640	480	0.307	378.4 / 309.6 / 263.9		378.4 / 191.4 / 190.8
HVGA	480	320	0.154	541.1 / 443.8 / 378.3		541.1 / 363.3 / 361.7
QVGA	320	240	0.077	686.8 / 569.5 / 483.8		
HQVGA	240	160	0.038	940.0 / 787.0 / 667.8		
QQVGA	160	120	0.019	1152.5 / 970.1 / 822.2		
Max. × half <sup>5</sup>	2464	1032	2.543	182.0 / 95.8 / 95.1	96.3 / 48.7 / 48.5	48.8 / 24.6 / 24.5
Max. × min.	2464	16	0.039	1942.7 / 1165.6 / 1101.8	1247.9 / 691.2 / 663.9	718.8 / 380.9 / 370.4
Min. × max.	16	2056	0.033	96.5 / 79.2 / 67.4		
Min. × min.	16	16	256 P	2794.3 / 2453.7 / 2061.5		

<sup>1</sup> Mono8 or Bayer...8<sup>(2)</sup> at **SensorBitDepth** = 8-Bit<sup>(3)</sup> /  
 Mono10 or Bayer...10 at **SensorBitDepth** = 10-Bit  
 Mono12 or Bayer...12 at **SensorBitDepth** = 12-Bit

<sup>2</sup> The three dots... represent the colors of a Bayer pixel format, such as in Bayer**RG8**.

<sup>3</sup> The **SensorBitDepth** value must be set separately from **PixelFormat**.

See [Sensor ADC readout modes for maximum frame rates](#) on page 72 for details.

<sup>4</sup> Instead of 1440 × 900 | <sup>5</sup> Instead of 2464 × 1028

If resolutions were not available due to increments, frame rates relate to the next available resolution.

Table 64: Alvium 1800 C-508m/c Pol ROI frame rates



## Alvium 1800 C-510m/c

Red table border lines signal that **GenICam for CSI-2 Access** is required.

Feature	Specification	
	1800 C-510m (monochrome)	1800 C-510c (color)
Sensor model	Sony IMX548	
Resolution	2464 (H) × 2064 (V); 5.1 MP	
Sensor type	CMOS	
Shutter type	Global shutter (GS)	
Sensor size	Type 1/1.8; 6.8 mm × 5.7 mm; 8.8 mm diagonal	
Pixel size	2.74 μm × 2.74 μm	
CRA	0 deg	
Sensor bit depth (ADC)	12-bit	
<b>Pixel formats, GenICam for CSI-2 Access</b>		
Monochrome pixel formats	Mono8 (default), Mono10, Mono10p, Mono12, Mono12p	Mono8, Mono10, Mono10p, Mono12, Mono12p
YUV color pixel formats	Not applicable	YCbCr411_8_CbYYCrYY, YCbCr422_8_CbYCrY, YCbCr8_CbYCr
RGB color pixel formats	Not applicable	BGR8, RGB8 (default)
Raw color pixel formats	Not applicable	BayerRG8, BayerRG10, BayerRG10p, BayerRG12, BayerRG12p
<b>Pixel formats, other access formats</b>		
YUV color pixel formats	Not applicable	YUV422 8-bit (UYVY)
RGB color pixel formats	Default: RGB888 (RGB3)	
RAW pixel formats	RAW8 (GREY), RAW10 (Y10), RAW12 (Y12)	
Maximum frame rate	81 fps, using 4 lanes	
Maximum frame rate	81 fps, using 4 lanes	
Exposure time	8 μs to 10 s (4 lanes)	
Exposure modes	Timed	
Gain	0 dB to 48 dB; 0.1 dB increments	
Digital binning	Horizontal: 1 to 8 columns; Vertical: 1 to 8 rows	
Sensor binning (H × V)	2 × 2 ( <i>Sum</i> )	Not applicable
Image buffer (RAM)	256 KByte	
Non-volatile memory (Flash)	1024 KByte	
GPIOs	2 programmable GPIOs As direct inputs (push-pull): 0 to 5.5 VDC As direct outputs (push-pull): 0 to 3.3 VDC at 12 mA	
Power requirements	Power over MIPI CSI-2	

Table 65: Alvium 1800 C-510m/c specifications (sheet 1 of 2)

Feature	Specification			
	<b>1800 C-510m/c</b>			
Power consumption (typical, at 5 VDC)	2.8 W			
Storage temperature	-20 °C to +85 °C ambient temperature			
<b>Operating temperature</b>	<b>Hardware option</b>	<b>Housing</b>	<b>Cooling area<sup>1</sup></b>	<b>Mainboard<sup>2</sup></b>
	Bare board <sup>3</sup>	Not applicable	-20 °C to +85 °C	-20 °C to +85 °C
	Open housing <sup>4</sup>	-20 °C to +65 °C		
Relative humidity	0% to 80% (non-condensing)			
Digital interface	MIPI CSI-2 D-PHY V1.1; 1, 2, or 4 lanes; maximum 1.051 Gbit/s per lane			
Camera controls	GenICam (GenICam for CSI-2 Access)			
	V4L2 controls (Video4Linux Access), Direct Register Access			
<sup>1</sup> See <a href="#">Mounting the heat sink</a> on page 256.				
<sup>2</sup> Output by <code>DeviceTemperature</code>				
<sup>3</sup> Ensure that the sensor is operated in the temperature range specified by the manufacturer. For any questions, please visit <a href="http://www.alliedvision.com/en/support">www.alliedvision.com/en/support</a> .				
<sup>4</sup> Temperature values must be observed for the housing <b>and</b> for the cooling area.				

Table 65: Alvium 1800 C-510m/c specifications (sheet 2 of 2)

## Absolute QE

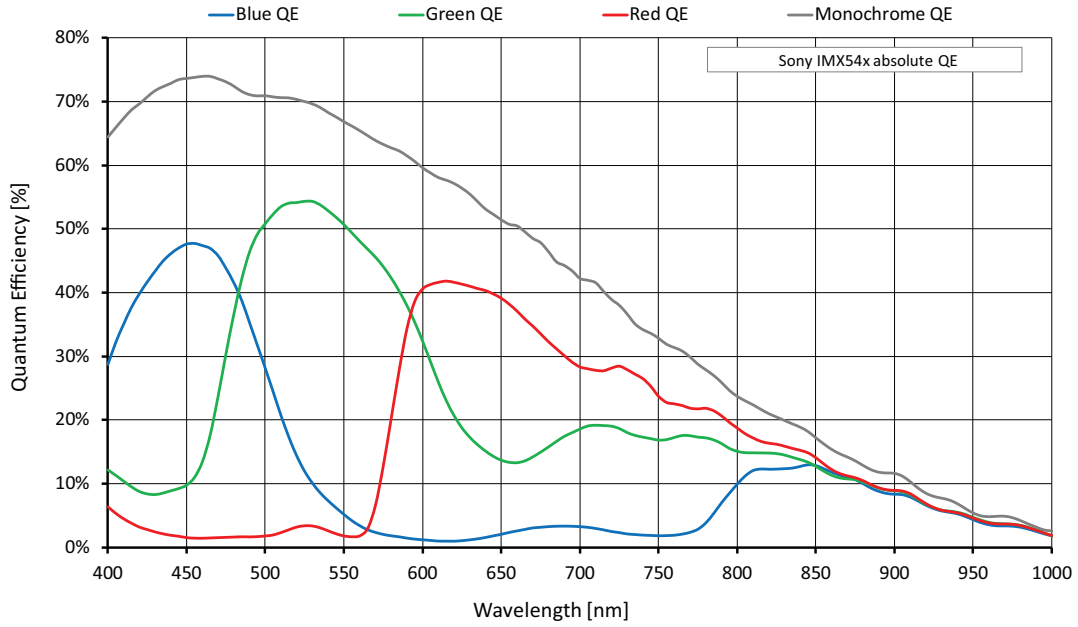

Figure 43: Alvium 1800 C-510m/c (Sony IMX548) absolute QE

## Spectral response

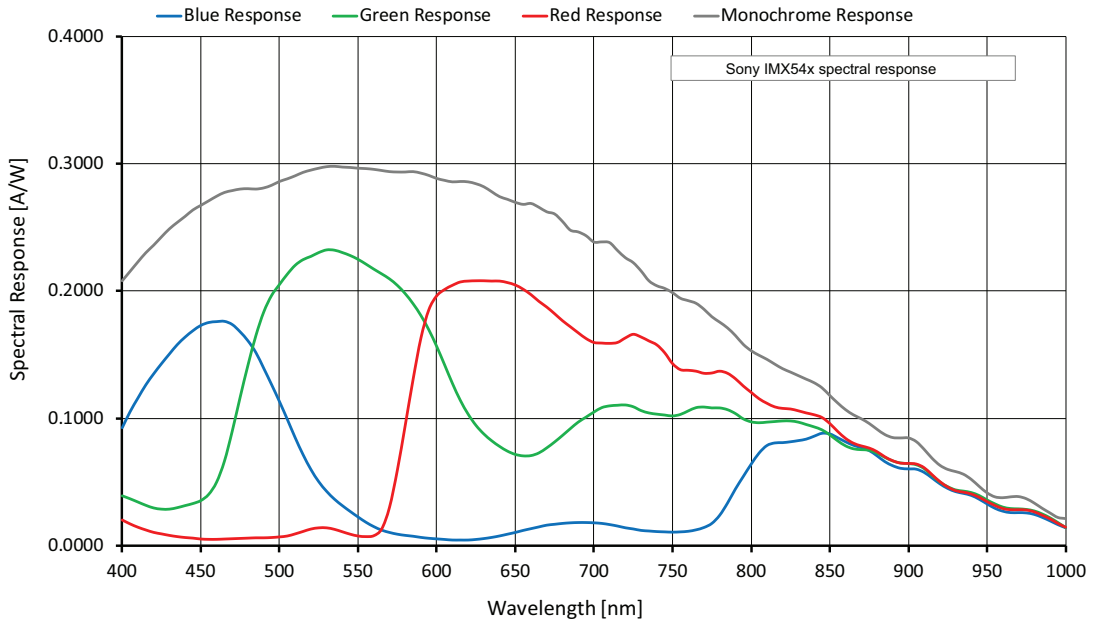

Figure 44: Alvium 1800 C-510m/c (Sony IMX548) spectral response

## Frame rates with Cropping

Values were calculated as defined in [Frame rates with ROI/Cropping](#) on page 71 and in [Operation for maximum frame rates](#) on page 73.

Frame rates at maximum bandwidth calculates for 1.051 Gbit/s per lane. To reach the maximum frame rate available for typical operation, the bandwidth for image traffic is at 4 lanes with 4.204 Gbit/s.

Image format	Width [pixels]	Height [pixels]	ROI area [MP]	Frame rate [fps] <sup>1</sup>		
				4-lane	2-lane	1-lane
				4.204 Gbit/s	2.102 Gbit/s	1.051 Gbit/s
Full resolution	2464	2064	5.086	81.5	47.3	23.8
QXGA	2048	1536	3.146	106.7	74.8	37.6
Full HD	1920	1080	2.074	145.5	108.7	54.8
UXGA	1600	1200	1.920	133.3	118.4	60.1
WXGA+ <sup>2</sup>	1440	904	1.302	170.1	168.5	85.1
SXGA	1280	1024	1.311	153.5		86.2
HD 720	1280	720	0.922	205.8		115.8
XGA	1024	768	0.786	196.1		137.2
SVGA	800	600	0.480	239.9		214.7
VGA	640	480	0.307	285.3		
HVGA	480	320	0.154	380.5		
QVGA	320	240	0.077	456.0		
HQVGA	240	160	0.038	569.0		
QQVGA	160	120	0.019	649.4		
Max. × half	2464	1032	2.543	150.2	87.8	44.4
Max. × min.	2464	16	0.039	887.8	555.3	295.4
Min. × max.	16	2064	0.033	82.5		
Min. × min.	16	16	256 P	1026.7		

<sup>1</sup> Mono8 or Bayer...8<sup>(2)</sup>, Mono10 or Bayer...10, or Mono12 or Bayer...12 at **SensorBitDepth** = 12-Bit

<sup>2</sup> The three dots... represent the colors of a Bayer pixel format, such as in Bayer**RG8**.

<sup>3</sup> Instead of 1440 × 900

If resolutions were not available due to increments, frame rates relate to the next available resolution.

Table 66: Alvium 1800 C-510m/c ROI frame rates



## Alvium 1800 C-511m/c

Red table border lines signal that **GeniCam for CSI-2 Access** is required.

Feature	Specification	
	1800 C-511m (monochrome)	1800 C-511c (color)
Sensor model	Sony IMX547	
Resolution	2464 (H) × 2064 (V); 5.1 MP	
Sensor type	CMOS	
Shutter type	Global shutter (GS)	
Sensor size	Type 1/1.8; 6.8 mm × 5.7 mm; 8.8 mm diagonal	
Pixel size	2.74 μm × 2.74 μm	
CRA	0 deg	
ADC bit depth	12-bit	
<b>Pixel formats, GeniCam for CSI-2 Access</b>		
Monochrome pixel formats	Mono8 (default), Mono10, Mono10p, Mono12, Mono12p	Mono8, Mono10, Mono10p, Mono12, Mono12p
YUV color pixel formats	Not applicable	YCbCr411_8_CbYYCrYY, YCbCr422_8_CbYCrY, YCbCr8_CbYCr
RGB color pixel formats	Not applicable	BGR8, RGB8 (default)
Raw color pixel formats	Not applicable	BayerRG8, BayerRG10, BayerRG10p, BayerRG12, BayerRG12p
<b>Pixel formats, other access modes</b>		
YUV color pixel formats	Not applicable	YUV422 8-bit (UYVY)
RGB color pixel formats	Default: RGB888 (RGB3)	
RAW pixel formats	RAW8 (GREY), RAW10 (Y10), RAW12 (Y12)	
Maximum frame rate	79 fps, using 4 lanes	
Maximum frame rate	79 fps, using 4 lanes	
Exposure time	8 μs to 10 s (4 lanes)	
Exposure modes	Timed, TriggerControlled, TriggerWidth	
Gain	0 dB to 48 dB; 0.1 dB increments	
Digital binning	Horizontal: 1 to 8 columns; Vertical: 1 to 8 rows	
Sensor binning (H × V)	2 × 2 ( <i>Sum</i> )	Not applicable
Image buffer (RAM)	256 KByte	
Non-volatile memory (Flash)	1024 KByte	
GPIOs	2 programmable GPIOs As direct inputs (push-pull): 0 to 5.5 VDC As direct outputs (push-pull): 0 to 3.3 VDC at 12 mA	
Power requirements	Power over MIPI CSI-2	

Table 67: Alvium 1800 C-511m/c specifications (sheet 1 of 2)



Feature	Specification			
	<b>1800 C-511m/c</b>			
Power consumption (typical, at 5 VDC)	3.0 W			
Storage temperature	-20 °C to +85 °C ambient temperature			
<b>Operating temperature</b>	<b>Hardware option</b>	<b>Housing</b>	<b>Cooling area<sup>1</sup></b>	<b>Mainboard<sup>2</sup></b>
	Bare board <sup>3</sup>	Not applicable	-20 °C to +85 °C	-20 °C to +85 °C
	Open housing <sup>4</sup>	-20 °C to +65 °C		
Relative humidity	0% to 80% (non-condensing)			
Digital interface	MIPI CSI-2 D-PHY V1.1; 1, 2, or 4 lanes; maximum 1.051 Gbit/s per lane			
Camera controls	GenICam (GenICam for CSI-2 Access) V4L2 controls (Video4Linux Access), Direct Register Access			
<sup>1</sup> See <a href="#">Mounting the heat sink</a> on page 256. <sup>2</sup> Output by <code>DeviceTemperature</code> <sup>3</sup> Ensure that the sensor is operated in the temperature range specified by the manufacturer. For any questions, please visit <a href="http://www.alliedvision.com/en/support">www.alliedvision.com/en/support</a> . <sup>4</sup> Temperature values must be observed for the housing <b>and</b> for the cooling area.				

Table 67: Alvium 1800 C-511m/c specifications (sheet 2 of 2)

## Absolute QE

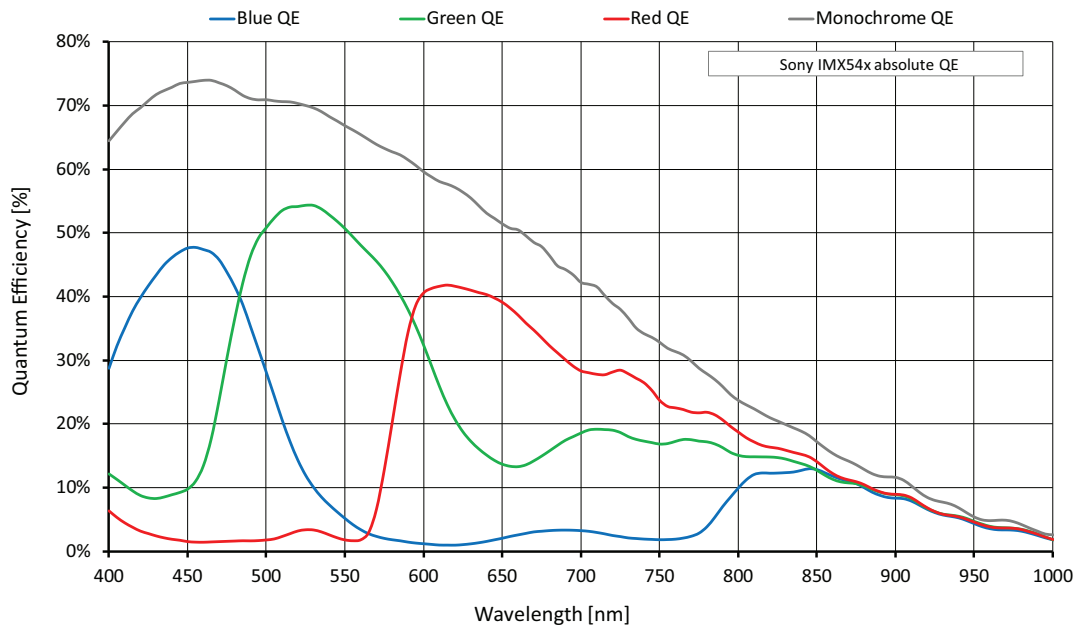

Figure 45: Alvium 1800 C-511m/c (Sony IMX547) absolute QE

## Spectral response

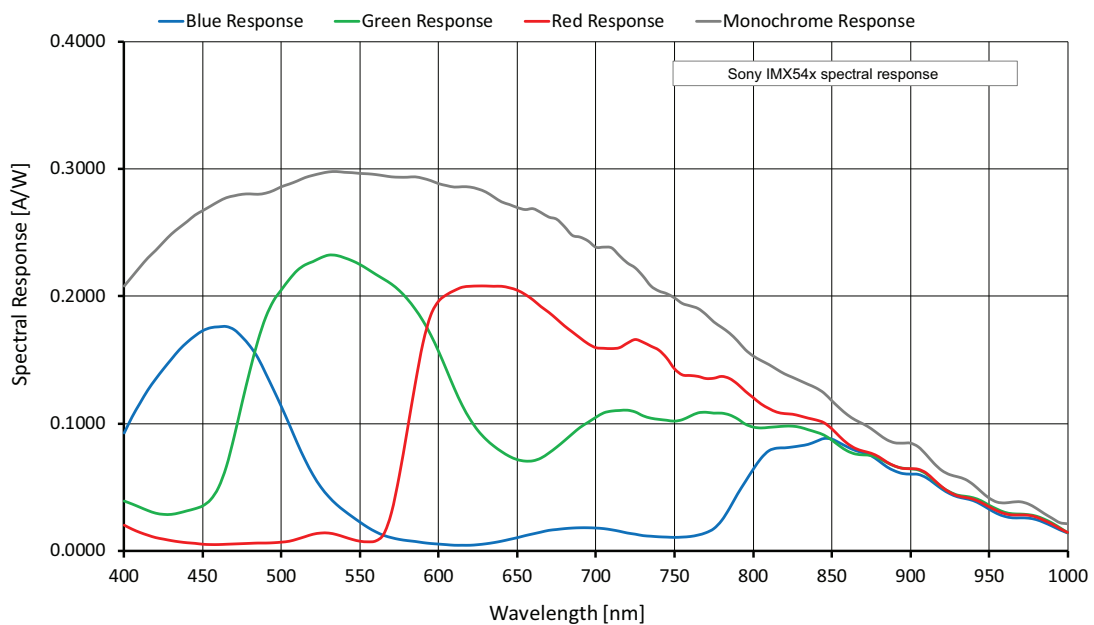

Figure 46: Alvium 1800 C-511m/c (Sony IMX547) spectral response

## Frame rates with Cropping

Values were calculated as defined in [Frame rates with ROI/Cropping](#) on page 71 and in [Operation for maximum frame rates](#) on page 73.

Frame rates at maximum bandwidth calculates for 1.051 Gbit/s per lane. To reach the maximum frame rate available for typical operation, the bandwidth for image traffic is at 4 lanes with 4.204 Gbit/s.

Image format	Width [pixels]	Height [pixels]	ROI area [MP]	Frame rate [fps] <sup>1</sup>		
				4-lane	2-lane	1-lane
				4.204 Gbit/s	2.102 Gbit/s	1.051 Gbit/s
Full resolution	2464	2064	5.086	79.9	47.3	23.8
QXGA	2048	1536	3.146	104.7	74.8	37.6
Full HD	1920	1080	2.074	142.8	108.7	54.8
UXGA	1600	1200	1.920	130.7	118.4	60.1
WXGA+ <sup>3</sup>	1440	904	1.302	167.0		85.1
SXGA	1280	1024	1.311	150.5		86.2
HD 720	1280	720	0.922	201.8		115.8
XGA	1024	768	0.786	192.3		137.2
SVGA	800	600	0.480	235.2		214.7
VGA	640	480	0.307	280.2		
HVGA	480	320	0.154	373.1		
QVGA	320	240	0.077	447.1		
HQVGA	240	160	0.038	557.9		
QQVGA	160	120	0.019	636.8		
Max. × half.	2464	1032	2.543	16	16	16
Max. × min.	2464	16	0.039	870.6	555.3	295.4
Min. × max.	16	2064	0.033	80.9		
Min. × min.	16	16	256 P	1006.8		

<sup>1</sup> Mono8 or Bayer...8<sup>(2)</sup>, Mono10 or Bayer...10, or Mono12 or Bayer...12 at **SensorBitDepth** = 12-Bit  
<sup>2</sup> The three dots... represent the colors of a Bayer pixel format, such as in Bayer**RG8**.  
<sup>3</sup> Instead of 1440 × 900  
 If resolutions were not available due to increments, frame rates relate to the next available resolution.

Table 68: Alvium 1800 C-511m/c ROI frame rates



## Alvium 1800 C-530 VSWIR (coming soon)

Red table border lines signal that **GenICam for CSI-2 Access** is required.

Feature	Specification
<b>1800 C-530 VSWIR (monochrome)</b>	
Sensor model	Sony IMX992
Resolution	2592(H) × 2056(V); 5.3 MP
Sensor type	InGaAs
Shutter type	Global shutter (GS)
Sensor size	Type 1/1.4; 8.9 mm × 7.1 mm; 11.4 mm diagonal
Pixel size	3.45 μm × 3.45 μm
CRA	Tbd
Sensor bit depth (ADC)	8-bit, 10-bit, 12-bit; Adaptive (10-bit, 12-bit)
Sensor bit depth (ADC)	12-bit
<b>Pixel formats, GenICam for CSI-2 Access</b>	
Monochrome pixel formats	Mono8 (default), Mono10, Mono10p, Mono12, Mono12p
<b>Pixel formats, other access modes</b>	
RAW pixel formats	RAW8 (GREY), RAW10 (Y10), RAW12 (Y12)
Maximum frame rate	84 fps, using 4 lanes
Maximum frame rate	58 fps, using 4 lanes
Exposure time	26 μs to 10 s (4 lanes)
Exposure modes	Timed, TriggerControlled, TriggerWidth
Gain	0 dB to 48 dB; 0.1 dB increments
Digital binning	Horizontal: 1 to 8 columns; Vertical: 1 to 8 rows
Image buffer (RAM)	256 KByte
Non-volatile memory (Flash)	1024 KByte
GPIOs	2 programmable GPIOs As direct inputs (push-pull): 0 to 5.5 VDC As direct outputs (push-pull): 0 to 3.3 VDC at 12 mA
Power requirements	Power over MIPI CSI-2
Power consumption (typical, at 5 VDC)	Tbd

Table 69: Alvium 1800 C-530 VSWIR specifications (sheet 1 of 2)

Feature	Specification			
	<b>1800 C-530 VSWIR</b>			
Storage temperature	-20 °C to +85 °C ambient temperature			
<b>Operating temperature</b>	<b>Hardware option</b>	<b>Housing</b>	<b>Cooling area<sup>1</sup></b>	<b>Mainboard<sup>2</sup></b>
	Bare board <sup>3</sup>	Not applicable	-20 °C to +85 °C	-20 °C to +85 °C
	Open housing <sup>4</sup>	-20 °C to +65 °C		
Relative humidity	0% to 80% (non-condensing)			
Digital interface	MIPI CSI-2 D-PHY V1.1; 1, 2, or 4 lanes; maximum 1.051 Gbit/s per lane			
Camera controls	GenICam (GenICam for CSI-2 Access)			
	V4L2 controls (Video4Linux Access), Direct Register Access			
<sup>1</sup> See <a href="#">Mounting the heat sink</a> on page 256. <sup>2</sup> Output by <code>DeviceTemperature</code> <sup>3</sup> Ensure that the sensor is operated in the temperature range specified by the manufacturer. For any questions, please visit <a href="http://www.alliedvision.com/en/support">www.alliedvision.com/en/support</a> . <sup>4</sup> Temperature values must be observed for the housing <b>and</b> for the cooling area.				

Table 69: Alvium 1800 C-530 VSWIR specifications (sheet 2 of 2)

## Absolute QE, spectral response

We intend to add diagrams in a future version of this document.

## Frame rates with Cropping

Values were calculated as defined in [Frame rates with ROI/Cropping](#) on page 71 and in [Operation for maximum frame rates](#) on page 73.

Frame rates at maximum bandwidth calculates for 1.051 Gbit/s per lane. To reach the maximum frame rate available for typical operation, the bandwidth for image traffic is at 4 lanes with 4.204 Gbit/s.

Image format	Width [pixels]	Height [pixels]	ROI area [MP]	Frame rate [fps] <sup>1</sup>		
				4-lane	2-lane	1-lane
				4.204 Gbit/s	2.102 Gbit/s	1.051 Gbit/s
Full resolution	2592	2056	5.329	84.7 / 45.4 / 45.2	45.5 / 22.9 / 22.8	22.9 / 11.5 / 11.5
QSXGA	2560	2048	5.243	85.0 / 46.2 / 46.1	46.4 / 23.3 / 23.2	23.3 / 11.7 / 11.7
WQHD	2560	1440	3.686	116.9 / 63.7 / 63.4	64.1 / 32.1 / 32.0	32.2 / 16.2 / 16.2
QXGA	2048	1536	3.146	110.9 / 75.2 / 74.7	75.4 / 37.9 / 37.9	38.0 / 19.1 / 19.0
Full HD	1920	1080	2.074	151.5 / 109.2 / 105.2	110.0 / 55.5 / 55.3	55.5 / 27.9 / 27.8
UXGA	1600	1200	1.920	138.8 / 113.3 / 96.4	119.6 / 60.6 / 60.4	60.6 / 30.5 / 30.4
WXGA+ <sup>3</sup>	1440	904	1.302	177.7 / 145.0 / 123.4	170.7 / 86.2 / 85.8	86.2 / 43.4 / 43.2
SXGA	1280	1024	1.311	160.0 / 130.7 / 111.1	160.0 / 87.0 / 86.7	87.3 / 43.8 / 43.8
HD 720	1280	720	0.922	215.2 / 175.8 / 149.4	215.2 / 117.3 / 116.8	117.7 / 59.1 / 59.2
XGA	1024	768	0.786	205.0 / 167.4 / 142.3	205.0 / 139.0 / 138.1	139.3 / 70.0 / 70.0
SVGA	800	600	0.480	251.9 / 205.4 / 174.8		216.8 / 110.0 / 109.6
VGA	640	480	0.307	300.7 / 245.5 / 209.0		300.7 / 163.3 / 162.8
HVGA	480	320	0.154	405.6 / 330.5 / 281.3		405.6 / 291.7 / 281.3
QVGA	320	240	0.077	492.0 / 401.8 / 341.9		
HQVGA	240	160	0.038	623.1 / 508.8 / 433.1		
QQVGA	160	120	0.019	723.0 / 590.4 / 500.6		
Max. × half <sup>4</sup>	2592	1032	2.675	156.3 / 84.2 / 83.6	84.6 / 42.8 / 42.5	42.8 / 21.5 / 21.5
Max. × min.	2592	16	0.041	966.4 / 552.0 / 535.2	570.0 / 299.9 / 293.7	304.7 / 156.4 / 154.6
Min. × max.	16	2056	0.033	86.2 / 70.4 / 60.0		
Min. × min.	16	16	0.000	1214.2 / 991.6 / 843.9		

<sup>1</sup> Mono8 at **SensorBitDepth** = 8-Bit<sup>(2)</sup> /  
 Mono10 at **SensorBitDepth** = 10-Bit  
 Mono12 at **SensorBitDepth** = 12-Bit

<sup>2</sup> The **SensorBitDepth** value must be set separately from **PixelFormat**.  
 See [Sensor ADC readout modes for maximum frame rates](#) on page 72 for details.

<sup>3</sup> Instead of 1440 × 900 | <sup>4</sup> Instead of 2592 × 1028  
 If resolutions were not available due to increments, frame rates relate to the next available resolution.

Table 70: Alvium 1800 C-530 VSWIR ROI frame rates



## Alvium 1800 C-811m/c

Red table border lines signal that **GeniCam for CSI-2 Access** is required.

Feature	Specification	
	1800 C-811m (monochrome)	1800 C-811c (color)
Sensor model	Sony IMX546	
Resolution	2848 (H) × 2848 (V); 8.1 MP	
Sensor type	CMOS	
Shutter type	Global shutter (GS)	
Sensor size	Type 2/3; 7.8 mm × 7.8 mm; 11.0 mm diagonal	
Pixel size	2.74 μm × 2.74 μm	
CRA	0 deg	
Sensor bit depth (ADC)	12-bit	
<b>Pixel formats, GeniCam for CSI-2 Access</b>		
Monochrome pixel formats	Mono8 (default), Mono10, Mono10p, Mono12, Mono12p	Mono8, Mono10, Mono10p, Mono12, Mono12p
YUV color pixel formats	Not applicable	YCbCr411_8_CbYYCrYY, YCbCr422_8_CbYCrY, YCbCr8_CbYCr
RGB color pixel formats	Not applicable	BGR8, RGB8 (default)
Raw color pixel formats	Not applicable	BayerRG8, BayerRG10, BayerRG10p, BayerRG12, BayerRG12p
<b>Pixel formats, other access modes</b>		
YUV color pixel formats	Not applicable	YUV422 8-bit (UYVY)
RGB color pixel formats	Default: RGB888 (RGB3)	
RAW pixel formats	RAW8 (GREY), RAW10 (Y10), RAW12 (Y12)	
Maximum frame rate	59 fps, using 4 lanes	
Maximum frame rate	59 fps, using 4 lanes	
Exposure time	8 μs to 10 s (4 lanes)	
Exposure modes	Timed, TriggerControlled, TriggerWidth	
Gain	0 dB to 48 dB; 0.1 dB increments	
Digital binning	Horizontal: 1 to 8 columns; Vertical: 1 to 8 rows	
Sensor binning (H × V)	2 × 2 ( <i>Sum</i> )	Not applicable
Image buffer (RAM)	256 KByte	
Non-volatile memory (Flash)	1024 KByte	
GPIOs	2 programmable GPIOs As direct inputs (push-pull): 0 to 5.5 VDC As direct outputs (push-pull): 0 to 3.3 VDC at 12 mA	
Power requirements	Power over MIPI CSI-2	

Table 71: Alvium 1800 C-811m/c specifications (sheet 1 of 2)

Feature	Specification			
	<b>1800 C-811m/c</b>			
Power consumption (typical, at 5 VDC)	3.1 W			
Storage temperature	-20 °C to +85 °C ambient temperature			
<b>Operating temperature</b>	<b>Hardware option</b>	<b>Housing</b>	<b>Cooling area<sup>1</sup></b>	<b>Mainboard<sup>2</sup></b>
	Bare board <sup>3</sup>	Not applicable	-20 °C to +85 °C	-20 °C to +85 °C
	Open housing <sup>4</sup>	-20 °C to +65 °C		
Relative humidity	0% to 80% (non-condensing)			
Digital interface	MIPI CSI-2 D-PHY V1.1; 1, 2, or 4 lanes; maximum 1.051 Gbit/s per lane			
Camera controls	GenICam (GenICam for CSI-2 Access) V4L2 controls (Video4Linux Access), Direct Register Access			
<sup>1</sup> See <a href="#">Mounting the heat sink</a> on page 256. <sup>2</sup> Output by <code>DeviceTemperature</code> <sup>3</sup> Ensure that the sensor is operated in the temperature range specified by the manufacturer. For any questions, please visit <a href="http://www.alliedvision.com/en/support">www.alliedvision.com/en/support</a> . <sup>4</sup> Temperature values must be observed for the housing <b>and</b> for the cooling area.				

Table 71: Alvium 1800 C-811m/c specifications (sheet 2 of 2)



### Absolute QE

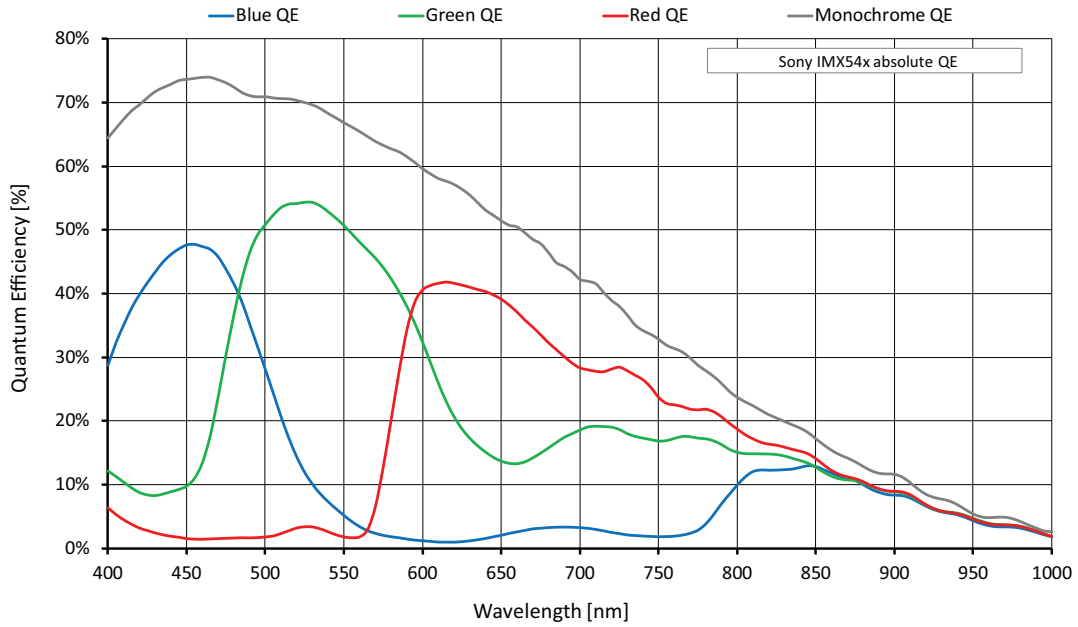

Figure 47: Alvium 1800 C-811m/c (Sony IMX546) absolute QE

### Spectral response

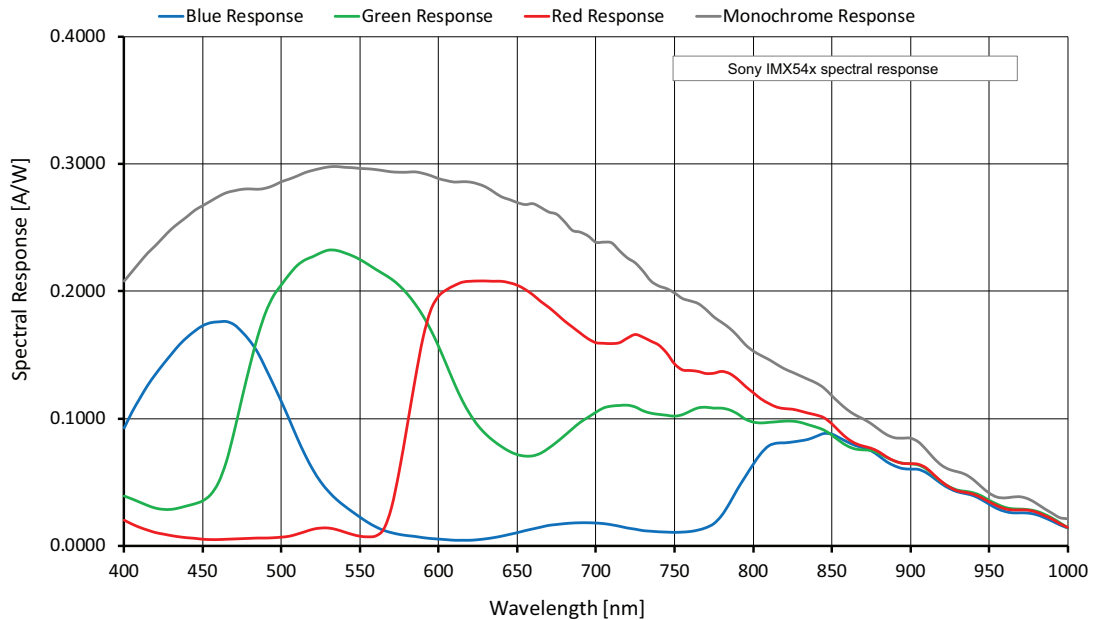

Figure 48: Alvium 1800 C-811m/c (Sony IMX546) spectral response

## Frame rates with Cropping

Values were calculated as defined in [Frame rates with ROI/Cropping](#) on page 71 and in [Operation for maximum frame rates](#) on page 73.

Frame rates at maximum bandwidth calculates for 1.051 Gbit/s per lane. To reach the maximum frame rate available for typical operation, the bandwidth for image traffic is at 4 lanes with 4.204 Gbit/s.

Image format	Width [pixels]	Height [pixels]	ROI area [MP]	Frame rate [fps] <sup>1</sup>		
				4-lane	2-lane	1-lane
				4.204 Gbit/s	2.102 Gbit/s	1.051 Gbit/s
Full resolution	2848	2848	8.111	59.2	30.4	15.2
QSXGA	2560	2048	5.243	80.4	46.1	23.1
WQHD	2560	1440	3.686	110.4	63.5	31.9
QXGA	2048	1536	3.146	104.7	74.8	37.6
Full HD	1920	1080	2.074	142.8	108.7	54.8
UXGA	1600	1200	1.920	130.7	118.4	60.1
WXGA+ <sup>3</sup>	1440	904	1.302	167.0		85.1
SXGA	1280	1024	1.311	150.5		86.2
HD 720	1280	720	0.922	201.8		115.8
XGA	1024	768	0.786	192.3		137.2
SVGA	800	600	0.480	235.2		214.7
VGA	640	480	0.307		280.2	
HVGA	480	320	0.154		373.1	
QVGA	320	240	0.077		447.1	
HQVGA	240	160	0.038		557.9	
QQVGA	160	120	0.019		636.8	
Max. × half	2848	1424	4.056	111.2	57.4	29.0
Max. × min.	2848	16	0.046	850.0	481.1	255.8
Min. × max.	16	2848	0.046		59.8	
Min. × min.	16	16	256 P		1006.8	

<sup>1</sup> Mono8 or Bayer...8<sup>(2)</sup>, Mono10 or Bayer...10, or Mono12 or Bayer...12 at **SensorBitDepth** = 12-Bit

<sup>2</sup> The three dots... represent the colors of a Bayer pixel format, such as in Bayer**RG8**.

<sup>3</sup> Instead of 1440 × 900

If resolutions were not available due to increments, frame rates relate to the next available resolution.

Table 72: Alvium 1800 C-811m/c ROI frame rates



## Alvium 1800 C-812 UV

Red table border lines signal that **GeniCam for CSI-2 Access** is required.



### NOTICE

#### Sensor aging by UV radiation

The sensor in this camera model is dedicated for imaging in the UV spectrum. However, UV radiation causes aging, which is permanently increasing the dark current and decreasing the QE (quantum efficiency).

To reduce sensor aging, we recommend you to:

- Minimize the intensity of UV radiation.
- Avoid wavelengths below 250 nm. For example, consider the use of bandpass filters to block shorter wavelengths.

Feature	Specification
	<b>1800 C-812 UV</b>
Sensor model	Sony IMX487
Resolution	2848 (H) × 2848 (V); 8.1 MP
Sensor type	CMOS
Shutter type	Global shutter (GS)
Sensor size	Type 2/3; 7.8 mm × 7.8 mm; 11.0 mm diagonal
Pixel size	2.74 μm × 2.74 μm
CRA	0 deg
Sensor bit depth (ADC)	12-bit
	<b>Pixel formats, GeniCam for CSI-2 Access</b>
Monochrome pixel formats	Mono8 (default), Mono10, Mono10p, Mono12, Mono12p
	<b>Pixel formats, other access modes</b>
RAW pixel formats	RAW8 (GREY), RAW10 (Y10), RAW12 (Y12)
Maximum frame rate	58 fps, using 4 lanes
Maximum frame rate	58 fps, using 4 lanes
Exposure time	8 μs to 10 s (4 lanes)
Exposure modes	Timed, TriggerControlled, TriggerWidth
Gain	0 dB to 48 dB; 0.1 dB increments
Digital binning	Horizontal: 1 to 8 columns; Vertical: 1 to 8 rows
Sensor binning (H × V)	2 × 2 ( <i>Sum</i> )                      Not applicable
Image buffer (RAM)	256 KByte
Non-volatile memory (Flash)	1024 KByte
GPIOs	2 programmable GPIOs As direct inputs (push-pull): 0 to 5.5 VDC As direct outputs (push-pull): 0 to 3.3 VDC at 12 mA
Power requirements	Power over MIPI CSI-2

Table 73: Alvium 1800 C-812 UV specifications (sheet 1 of 2)

Feature	Specification			
	<b>1800 C-812 UV</b>			
Power consumption (typical, at 5 VDC)	3.7 W			
Storage temperature	-20 °C to +85 °C ambient temperature			
<b>Operating temperature</b>	<b>Hardware option</b>	<b>Housing</b>	<b>Cooling area<sup>1</sup></b>	<b>Mainboard<sup>2</sup></b>
	Bare board <sup>3</sup>	Not applicable	-20 °C to +85 °C	-20 °C to +85 °C
	Open housing <sup>4</sup>	-20 °C to +65 °C		
Relative humidity	0% to 80% (non-condensing)			
Digital interface	MIPI CSI-2 D-PHY V1.1; 1, 2, or 4 lanes; maximum 1.051 Gbit/s per lane			
Camera controls	GenICam (GenICam for CSI-2 Access)			
	V4L2 controls (Video4Linux Access), Direct Register Access			
<sup>1</sup> See <a href="#">Mounting the heat sink</a> on page 256. <sup>2</sup> Output by DeviceTemperature <sup>3</sup> Ensure that the sensor is operated in the temperature range specified by the manufacturer. For any questions, please visit <a href="http://www.alliedvision.com/en/support">www.alliedvision.com/en/support</a> . <sup>4</sup> Temperature values must be observed for the housing <b>and</b> for the cooling area.				

Table 73: Alvium 1800 C-812 UV specifications (sheet 2 of 2)

### Absolute QE

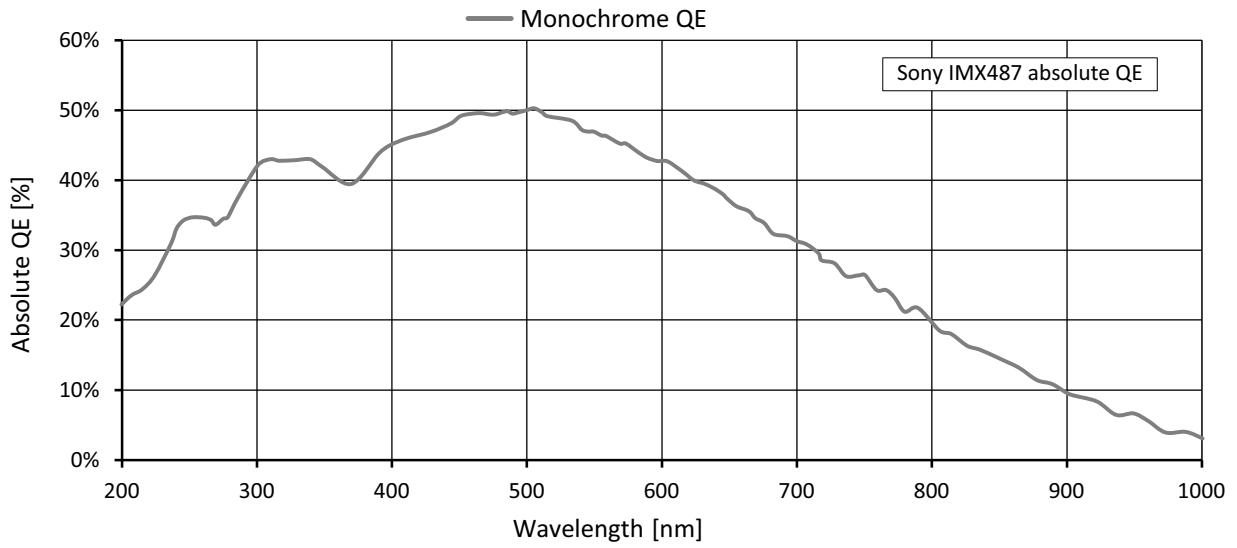

Figure 49: Alvium 1800 C-812 UV (Sony IMX487) absolute QE

### Spectral response

We intend to add a diagram in a future version of this document.

## Frame rates with Cropping

Values were calculated as defined in [Frame rates with ROI/Cropping](#) on page 71 and in [Operation for maximum frame rates](#) on page 73.

Frame rates at maximum bandwidth calculates for 1.051 Gbit/s per lane. To reach the maximum frame rate available for typical operation, the bandwidth for image traffic is at 4 lanes with 4.204 Gbit/s.

Image format	Width [pixels]	Height [pixels]	ROI area [MP]	Frame rate [fps] <sup>1</sup>		
				4-lane	2-lane	1-lane
				4.204 Gbit/s	2.102 Gbit/s	1.051 Gbit/s
Full resolution	2848	2848	8.111	58.8	30.2	15.1
QSXGA	2560	2048	5.243	79.7	45.7	22.9
WQHD	2560	1440	3.686	109.0	62.7	31.5
QXGA	2048	1536	3.146	103.5	73.9	37.2
Full HD	1920	1080	2.074	139.7	106.3	53.6
UXGA	1600	1200	1.920	128.9	116.7	59.3
WXGA+ <sup>3</sup>	1440	904	1.302	162.8		82.9
SXGA	1280	1024	1.311	148.0		84.8
HD 720	1280	720	0.922	197.3		113.3
XGA	1024	768	0.786	188.3		134.3
SVGA	800	600	0.480	226.9		207.1
VGA	640	480	0.307	271.8		
HVGA	480	320	0.154	358.2		
QVGA	320	240	0.077	426.0		
HQVGA	240	160	0.038	525.4		
QQVGA	160	120	0.019	579.4		
Max. × half	2848	1424	4.056	109.8	56.7	28.6
Max. × min.	2848	16	0.046	776.8	435.5	230.3
Min. × max.	16	2848	0.046	59.4		
Min. × min.	16	16	256 P	905.6		

<sup>1</sup> Mono8 or Bayer...8<sup>(2)</sup>, Mono10 or Bayer...10, or Mono12 or Bayer...12 at **SensorBitDepth** = 12-Bit

<sup>2</sup> The three dots... represent the colors of a Bayer pixel format, such as in Bayer**RG8**.

<sup>3</sup> Instead of 1440 × 900

If resolutions were not available due to increments, frame rates relate to the next available resolution.

Table 74: Alvium 1800 C-812 UV ROI frame rates



## Alvium 1800 C-895m/c

Red table border lines signal that **GeniCam for CSI-2 Access** is required.

Feature	Specification	
	1800 C-895m (monochrome)	1800 C-895c (color)
Sensor model	Sony IMX267	
Resolution	4112 (H) × 2176 (V); 8.95 MP	
Sensor type	CMOS	
Shutter type	Global shutter (GS)	
Sensor size	Type 1; 14.2 mm × 7.5 mm; 16.0 mm diagonal	
Pixel size	3.45 μm × 3.45 μm	
CRA	0 deg	
ADC bit depth	12-bit	
<b>Pixel formats, GeniCam for CSI-2 Access</b>		
Monochrome pixel formats	Mono8 (default), Mono10, Mono10p, Mono12, Mono12p	Mono8, Mono10, Mono10p, Mono12, Mono12p
YUV color pixel formats	Not applicable	YCbCr411_8_CbYYCrYY, YCbCr422_8_CbYCrY, YCbCr8_CbYCr
RGB color pixel formats	Not applicable	BGR8, RGB8 (default)
Raw color pixel formats	Not applicable	BayerRG8, BayerRG10, BayerRG10p, BayerRG12, BayerRG12p
<b>Pixel formats, other access modes</b>		
YUV color pixel formats	Not applicable	YUV422 8-bit (UYVY)
RGB color pixel formats	Default: RGB888 (RGB3)	
RAW pixel formats	RAW8 (GREY), RAW10 (Y10), RAW12 (Y12)	
Maximum frame rate	31 fps, using 4 lanes	
Maximum frame rate	31 fps, using 4 lanes	
Exposure time	29 μs to 10 s (4 lanes)	
Exposure modes	Timed, TriggerControlled, TriggerWidth	
Gain	0 dB to 48 dB; 0.1 dB increments	
Digital binning <sup>1</sup>	Horizontal: 1 to 8 columns; Vertical: 1 to 8 rows	
Image buffer (RAM)	256 KByte	
Non-volatile memory (Flash)	1024 KByte	
GPIOs	2 programmable GPIOs As direct inputs (push-pull): 0 to 5.5 VDC As direct outputs (push-pull): 0 to 3.3 VDC at 12 mA	
<sup>1</sup> Digital vertical binning can be used only when digital horizontal binning is used as well		

Table 75: Alvium 1800 C-895m/c specifications (sheet 1 of 2)

Feature	Specification			
	<b>1800 C-895m/c</b>			
Power requirements	Power over MIPI CSI-2			
Power consumption (typical, at 5 VDC)	2.6 W			
Storage temperature	-20 °C to +85 °C ambient temperature			
<b>Operating temperature</b>	<b>Hardware option</b>	<b>Housing</b>	<b>Cooling area<sup>2</sup></b>	<b>Mainboard<sup>3</sup></b>
	Bare board <sup>4</sup>	Not applicable	-20 °C to +85 °C	-20 °C to +88 °C
	Open housing <sup>5</sup>	-20 °C to +65 °C		
Relative humidity	0% to 80% (non-condensing)			
Digital interface	MIPI CSI-2 D-PHY V1.1; 1, 2, or 4 lanes; maximum 1.051 Gbit/s per lane			
Camera controls	GenICam (GenICam for CSI-2 Access)			
	V4L2 controls (Video4Linux Access), Direct Register Access			
<sup>2</sup> See <a href="#">Mounting the heat sink</a> on page 256. <sup>3</sup> Output by DeviceTemperature <sup>4</sup> Ensure that the sensor is operated in the temperature range specified by the manufacturer. For any questions, please visit <a href="http://www.alliedvision.com/en/support">www.alliedvision.com/en/support</a> . <sup>5</sup> Temperature values must be observed for the housing <b>and</b> for the cooling area.				

Table 75: Alvium 1800 C-895m/c specifications (sheet 2 of 2)

## Absolute QE, spectral response

We intend to add diagrams in a future version of this document.



## Frame rates with Cropping

Values were calculated as defined in [Frame rates with ROI/Cropping](#) on page 71 and in [Operation for maximum frame rates](#) on page 73.

Frame rates at maximum bandwidth calculates for 1.051 Gbit/s per lane. To reach the maximum frame rate available for typical operation, the bandwidth for image traffic is at 4 lanes with 4.204 Gbit/s.

Image format	Width [pixels]	Height [pixels]	ROI area [MP]	Frame rate [fps] <sup>1</sup>		
				4-lane	2-lane	1-lane
				4.204 Gbit/s	2.102 Gbit/s	1.051 Gbit/s
Full resolution	4112	2176	8.948	31.5	28.3	14.3
UHD 4K	3840	2160	8.294	31.8	30.6	15.4
QSXGA	2560	2048	5.243	33.6		24.3
WQHD	2560	1440	3.686	47.2		34.1
QXGA	2048	1536	3.146	44.5		40.2
Full HD	1920	1080	2.074	62.3		60.0
UXGA	1600	1200	1.920	56.5		
WXGA+ <sup>3</sup>	1440	904	1.302	74.1		
SXGA	1280	1024	1.311	65.9		
HD 720	1280	720	0.922	91.8		
XGA	1024	768	0.786	86.6		
SVGA	800	600	0.480	109.2		
VGA	640	480	0.307	134.4		
HVGA	480	320	0.154	193.3		
QVGA	320	240	0.077	247.8		
HQVGA	240	160	0.038	345.2		
QQVGA	160	120	0.019	428.4		
Max. × half	4112	1088	4.474	60.9	54.8	27.8
Max. × min.	4112	16	0.066	740.8	693.4	419.7
Min. × max.	16	2176	0.035	32.0		
Min. × min.	16	16	256 P	1147.1		

<sup>1</sup> Mono8 or Bayer...8<sup>(2)</sup>, Mono10 or Bayer...10, or Mono12 or Bayer...12 at **SensorBitDepth** = 12-Bit  
<sup>2</sup> The three dots... represent the colors of a Bayer pixel format, such as in Bayer**RG8**.  
<sup>3</sup> Instead of 1440 × 900  
 If resolutions were not available due to increments, frame rates relate to the next available resolution.

Table 76: Alvium 1800 C-895m/c ROI frame rates



## Alvium 1800 C-1236m/c

Red table border lines signal that **GeniCam for CSI-2 Access** is required.

Feature	Specification	
	1800 C-1236m (monochrome)	1800 C-1236c (color)
Sensor model	Sony IMX304	
Resolution	4112 (H) × 3008 (V); 12.4 MP	
Sensor type	CMOS	
Shutter type	Global shutter (GS)	
Sensor size	Type 1.1; 14.2 mm × 10.4 mm; 17.6 mm diagonal	
Pixel size	3.45 μm × 3.45 μm	
CRA	0 deg	
ADC bit depth	12-bit	
<b>Pixel formats, GeniCam for CSI-2 Access</b>		
Monochrome pixel formats	Mono8 (default), Mono10, Mono10p, Mono12, Mono12p,	Mono8, Mono10, Mono10p, Mono12, Mono12p
YUV color pixel formats	Not applicable	YCbCr411_8_CbYYCrYY, YCbCr422_8_CbYCrY, YCbCr8_CbYCr
RGB color pixel formats	Not applicable	BGR8, RGB8 (default)
Raw color pixel formats	Not applicable	BayerRG8, BayerRG10, BayerRG10p, BayerRG12, BayerRG12p
<b>Pixel formats, other access modes</b>		
YUV color pixel formats	Not applicable	YUV422 8-bit (UYVY)
RGB color pixel formats	Default: RGB888 (RGB3)	
RAW pixel formats	RAW8 (GREY), RAW10 (Y10), RAW12 (Y12)	
Maximum frame rate	22 fps, using 4 lanes	
Maximum frame rate	22 fps, using 4 lanes	
Exposure time	29 μs to 10 s (4 lanes)	
Exposure modes	Timed, TriggerControlled, TriggerWidth	
Gain	0 dB to 48 dB; 0.1 dB increments	
Digital binning <sup>1</sup>	Horizontal: 1 to 8 columns; Vertical: 1 to 8 rows	
Image buffer (RAM)	256 KByte	
Non-volatile memory (Flash)	1024 KByte	
GPIOs	2 programmable GPIOs As direct inputs (push-pull): 0 to 5.5 VDC As direct outputs (push-pull): 0 to 3.3 VDC at 12 mA	
<sup>1</sup> Digital vertical binning can be used only when digital horizontal binning is used as well.		

Table 77: Alvium 1800 C-1236m/c specifications (sheet 1 of 2)

Feature	Specification			
	<b>1800 C-1236m/c</b>			
Power requirements	Power over MIPI CSI-2			
Power consumption (typical, at 5 VDC)	2.6 W			
Storage temperature	-20 °C to +85 °C ambient temperature			
<b>Operating temperature</b>	<b>Hardware option</b>	<b>Housing</b>	<b>Cooling area<sup>2</sup></b>	<b>Mainboard<sup>3</sup></b>
	Bare board <sup>4</sup>	Not applicable	-20 °C to +85 °C	-20 °C to +88 °C
	Open housing <sup>5</sup>	-20 °C to +65 °C		
Relative humidity	0% to 80% (non-condensing)			
Digital interface	MIPI CSI-2 D-PHY V1.1; 1, 2, or 4 lanes; maximum 1.051 Gbit/s per lane			
Camera controls	GenICam (GenICam for CSI-2 Access)			
	V4L2 controls (Video4Linux Access), Direct Register Access			
<sup>2</sup> See <a href="#">Mounting the heat sink</a> on page 256.				
<sup>3</sup> Output by <code>DeviceTemperature</code>				
<sup>4</sup> Ensure that the sensor is operated in the temperature range specified by the manufacturer. For any questions, please visit <a href="http://www.alliedvision.com/en/support">www.alliedvision.com/en/support</a> .				
<sup>5</sup> Temperature values must be observed for the housing <b>and</b> for the cooling area.				

Table 77: Alvium 1800 C-1236m/c specifications (sheet 2 of 2)

### Absolute QE

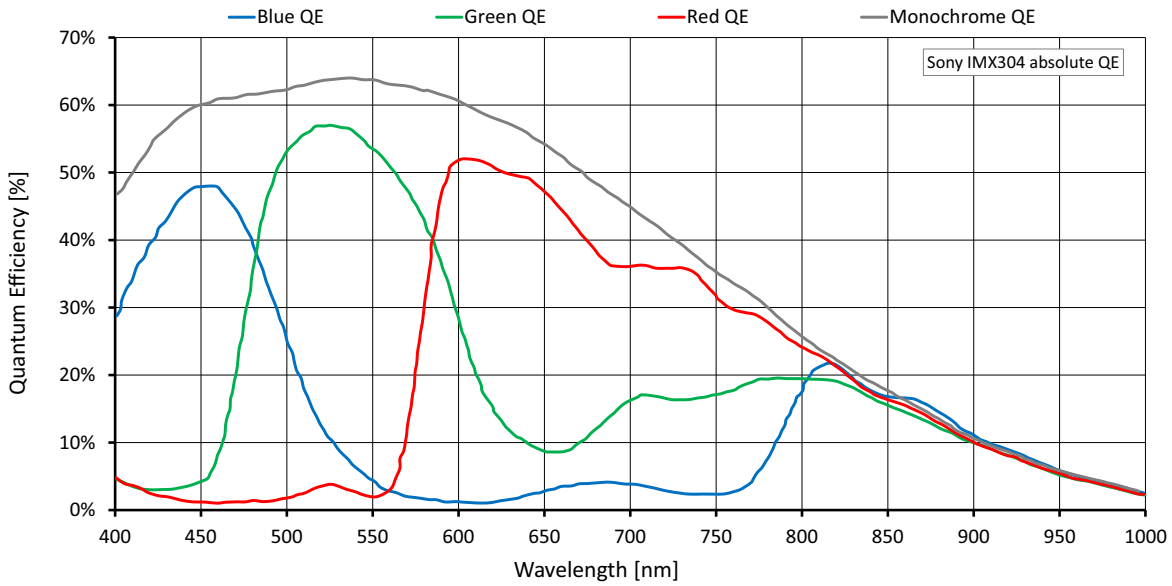

Figure 50: Alvium 1800 C-1236m/c (Sony IMX304) absolute QE

### Spectral response

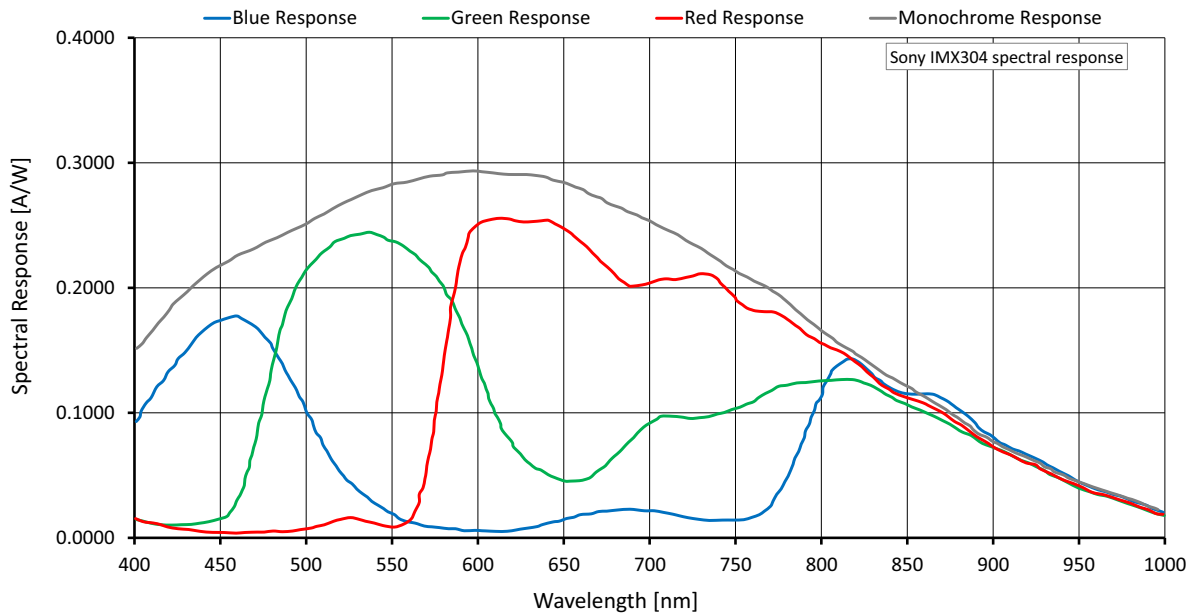

Figure 51: Alvium 1800 C-1236m/c (Sony IMX304) spectral response

## Frame rates with Cropping

Values were calculated as defined in [Frame rates with ROI/Cropping](#) on page 71 and in [Operation for maximum frame rates](#) on page 73.

Frame rates at maximum bandwidth calculates for 1.051 Gbit/s per lane. To reach the maximum frame rate available for typical operation, the bandwidth for image traffic is at 4 lanes with 4.204 Gbit/s.

Image format	Width [pixels]	Height [pixels]	ROI area [MP]	Frame rate [fps] <sup>1</sup>		
				4-lane	2-lane	1-lane
				4.204 Gbit/s	2.102 Gbit/s	1.051 Gbit/s
Full resolution	4112	3008	12.369	22.9	20.6	10.3
UHD 4K	3840	2160	8.294	31.6	30.5	15.3
QXGA	2560	2048	5.243	33.5		24.1
WQHD	2560	1440	3.686	47.0		33.9
QXGA	2048	1536	3.146	44.3		40.0
Full HD	1920	1080	2.074	62.0		59.6
UXGA	1600	1200	1.920	56.2		
WXGA+ <sup>3</sup>	1440	904	1.302	73.6		
SXGA	1280	1024	1.311	65.5		
HD 720	1280	720	0.922	91.0		
XGA	1024	768	0.786	86.0		
SVGA	800	600	0.480	108.2		
VGA	640	480	0.307	132.9		
HVGA	480	320	0.154	190.1		
QVGA	320	240	0.077	242.7		
HQVGA	240	160	0.038	335.4		
QQVGA	160	120	0.019	413.4		
Max. × half	4112	1504	6.184	44.7	40.2	20.3
Max. × min.	4112	16	0.066	697.2	650.9	388.9
Min. × max.	16	3008	0.048	23.2		
Min. × min.	16	16	256 P	1045.8		

<sup>1</sup> Mono8 or Bayer...8<sup>(2)</sup>, Mono10 or Bayer...10, or Mono12 or Bayer...12 at **SensorBitDepth** = 12-Bit

<sup>2</sup> The three dots... represent the colors of a Bayer pixel format, such as in Bayer**RG8**..

<sup>3</sup> Instead of 1440 × 900

If resolutions were not available due to increments, frame rates relate to the next available resolution.

Table 78: Alvium 1800 C-1236m/c ROI frame rates



## Alvium 1800 C-1240m/c

Red table border lines signal that **GeniCam for CSI-2 Access** is required.

Feature	Specification	
	1800 C-1240m (monochrome)	1800 C-1240c (color)
Sensor model	Sony IMX226	
Resolution	4024 (H) x 3036 (V); 12.2 MP	
Sensor type	CMOS	
Shutter type	Rolling shutter (RS), Global reset shutter (GRS)	
Sensor size	Type 1/1.7; 7.4 mm x 5.6 mm; 9.3 mm diagonal	
Pixel size	1.85 μm x 1.85 μm	
CRA	0 deg	
Sensor bit depth (ADC)	10-bit	
<b>Pixel formats, GeniCam for CSI-2 Access</b>		
Monochrome pixel formats	Mono8 (default), Mono10, Mono10p, Mono12, Mono12p	Mono8, Mono10, Mono10p, Mono12, Mono12p
YUV color pixel formats	Not applicable	YCbCr411_8_CbYYCrYY, YCbCr422_8_CbYCrY, YCbCr8_CbYCr
RGB color pixel formats	Not applicable	BGR8, RGB8 (default)
Raw color pixel formats	Not applicable	BayerRG8, BayerRG10, BayerRG10p, BayerRG12, BayerRG12p
<b>Pixel formats, other access modes</b>		
YUV color pixel formats	Not applicable	YUV422 8-bit (UYVY)
RGB color pixel formats	Default: RGB888 (RGB3)	
RAW pixel formats	RAW8 (GREY), RAW10 (Y10)	
Maximum frame rate	41 fps <sup>1</sup> , using 4 lanes	
Maximum frame rate	41 fps <sup>1</sup> , using 4 lanes	
Exposure time	10 μs to 10 s (4 lanes)	
Exposure modes	Timed	
Gain	0 dB to 27 dB; 0.1 dB increments	
Digital binning <sup>2</sup>	Horizontal: 1 to 8 columns; Vertical: 1 to 8 rows	
Image buffer (RAM)	256 KByte	
Non-volatile memory (Flash)	1024 KByte	
GPIOs	2 programmable GPIOs As direct inputs (push-pull): 0 to 5.5 VDC As direct outputs (push-pull): 0 to 3.3 VDC at 12 mA	
<sup>1</sup> In triggered mode: ~41 fps		
<sup>2</sup> Digital vertical binning can be used only when digital horizontal binning is used as well.		

Table 79: Alvium 1800 C-1240m/c specifications (sheet 1 of 2)

Feature	Specification			
	<b>1800 C-1240m/c</b>			
Power requirements	Power over MIPI CSI-2			
Power consumption (typical, at 5 VDC)	2.9 W			
Storage temperature	-20 °C to +85 °C ambient temperature			
<b>Operating temperature</b>	<b>Hardware option</b>	<b>Housing</b>	<b>Cooling area<sup>3</sup></b>	<b>Mainboard<sup>4</sup></b>
	Bare board <sup>5</sup>	Not applicable	-20 °C to +85 °C	-20 °C to +88 °C
	Open housing <sup>6</sup>	-20 °C to +65 °C		
Relative humidity	0% to 80% (non-condensing)			
Digital interface	MIPI CSI-2 D-PHY V1.1; 1, 2, or 4 lanes; maximum 1.051 Gbit/s per lane			
Camera controls	GenICam (GenICam for CSI-2 Access)			
	V4L2 controls (Video4Linux Access), Direct Register Access			
<sup>3</sup> See <a href="#">Mounting the heat sink</a> on page 256.				
<sup>4</sup> Output by <code>DeviceTemperature</code>				
<sup>5</sup> Ensure that the sensor is operated in the temperature range specified by the manufacturer. For any questions, please visit <a href="http://www.alliedvision.com/en/support">www.alliedvision.com/en/support</a> .				
<sup>6</sup> Temperature values must be observed for the housing <b>and</b> for the cooling area.				

Table 79: Alvium 1800 C-1240m/c specifications (sheet 2 of 2)

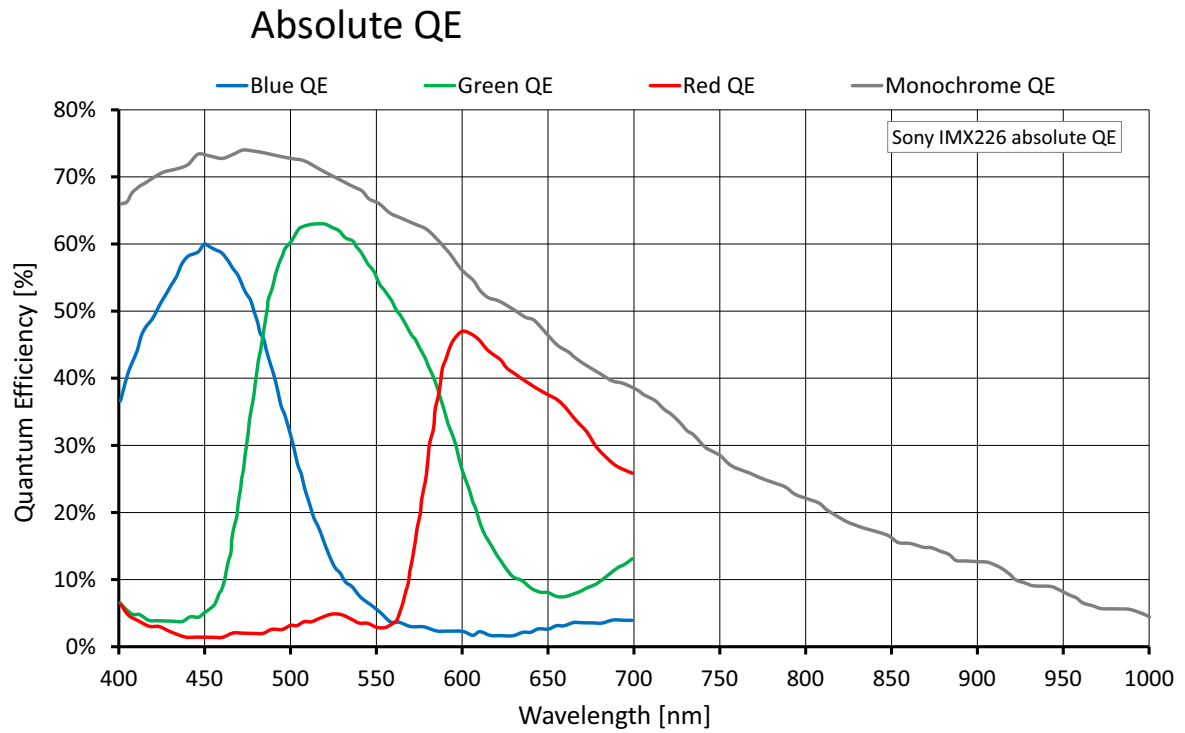

Figure 52: Alvium 1800 C-1240m/c (Sony IMX226) absolute QE

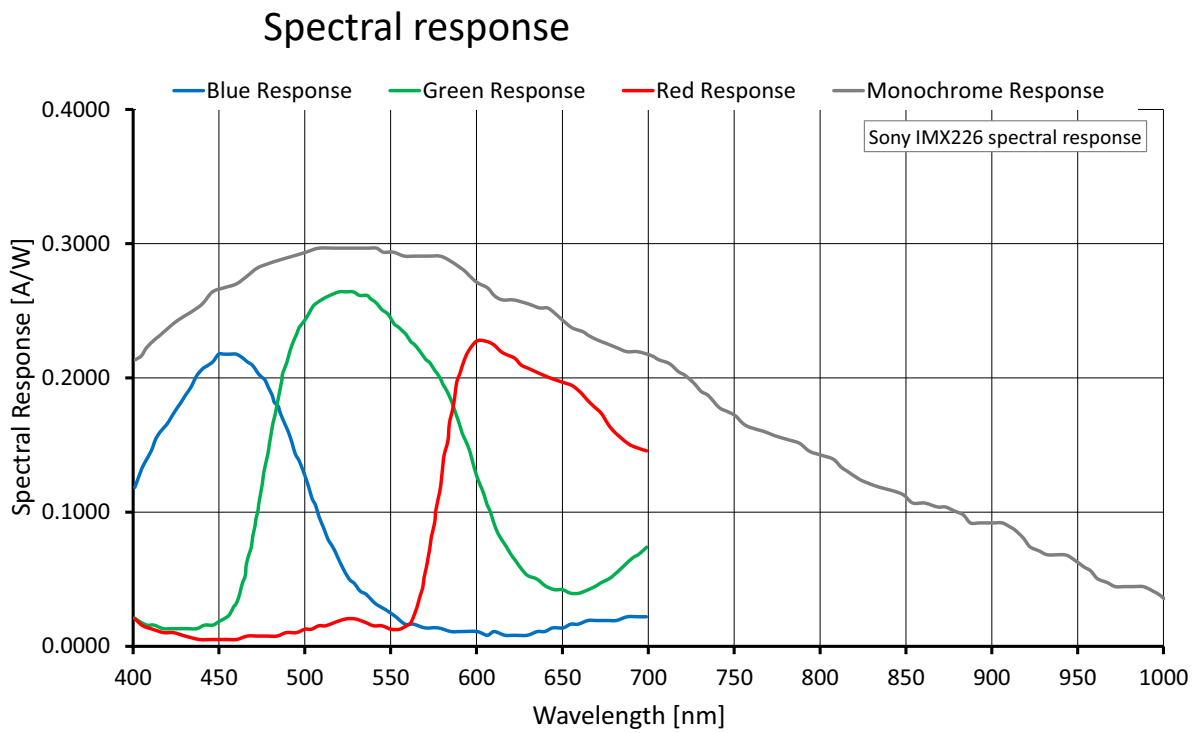

Figure 53: Alvium 1800 C-1240m/c (Sony IMX226) spectral response



## Frame rates with Cropping

Values were calculated as defined in [Frame rates with ROI/Cropping](#) on page 71 and in [Operation for maximum frame rates](#) on page 73.

Frame rates at maximum bandwidth calculates for 1.051 Gbit/s per lane. To reach the maximum frame rate available for typical operation, the bandwidth for image traffic is at 4 lanes with 4.204 Gbit/s. .

Shutter mode	User mode	Available frame rates
Rolling shutter (RS)	Freerun	Values in <a href="#">Table 81</a> below are reached.
Rolling shutter (RS)	Triggered	>99% of the values for in <a href="#">Table 81</a> below are reached.
Global reset shutter (GRS)	Freerun	>99% of the values for in <a href="#">Table 81</a> below are reached.
Global reset shutter (GRS)	Triggered	

Table 80: Frame rate behavior for different configurations

Image format	Width [pixels]	Height [pixels]	ROI area [MP]	Frame rate [fps] <sup>1</sup>		
				4-lane	2-lane	1-lane
				4.204 Gbit/s	2.102 Gbit/s	1.051 Gbit/s
Full resolution	4024	3036	12.217	41.2	20.9	10.5
UHD 4K	3840	2160	8.294			
QSXGA	2560	2048	5.243			
WQHD	2560	1440	3.686			
QXGA	2048	1536	3.146			
Full HD	1920	1080	2.074			
UXGA	1600	1200	1.920			
WXGA+ <sup>3</sup>	1440	904	1.302			
SXGA	1280	1024	1.311			
HD 720	1280	720	0.922			
XGA	1024	768	0.786			
SVGA	800	600	0.480			
VGA	640	480	0.307			
HVGA	480	320	0.154			
QVGA	320	240	0.077			
HQVGA	240	160	0.038			
QQVGA	160	120	0.019			
Max. × half <sup>4</sup>	4024	1520	6.116			
Max. × min.	4024	16	0.064			
Min. × max.	16	3036	0.049			
Min. × min.	16	16	256 P			

<sup>1</sup> Mono8 or Bayer...8<sup>(2)</sup>, Mono10 or Bayer...10, or Mono12 or Bayer...12 at SensorBitDepth = 10-Bit

<sup>2</sup> The three dots... represent the colors of a Bayer pixel format, such as in BayerRG8.

<sup>3</sup> Instead of 1440 × 900 | <sup>4</sup> Instead of 4024 × 1518

If resolutions were not available due to increments, frame rates relate to the next available resolution.

Table 81: Alvim 1800 C-1240m/c ROI frame rates



## Alvium 1800 C-1242m/c

Red table border lines signal that **GeniCam for CSI-2 Access** is required.

Feature	Specification	
	1800 C-1242m (monochrome)	1800 C-1242c (color)
Sensor model	Sony IMX545	
Resolution	4128 (H) × 3008 (V); 12.4 MP	
Sensor type	CMOS	
Shutter type	Global shutter (GS)	
Sensor size	Type 1/1.1; 11.3 mm × 8.2 mm; 14.0 mm diagonal	
Pixel size	2.74 μm × 2.74 μm	
CRA	0 deg	
Sensor bit depth (ADC)	12-bit	
<b>Pixel formats, GeniCam for CSI-2 Access</b>		
Monochrome pixel formats	Mono8 (default), Mono10, Mono10p, Mono12, Mono12p	Mono8, Mono10, Mono10p, Mono12, Mono12p
YUV color pixel formats	Not applicable	YCbCr411_8_CbYYCrYY, YCbCr422_8_CbYCrY, YCbCr8_CbYCr
RGB color pixel formats	Not applicable	BGR8, RGB8 (default)
Raw color pixel formats	Not applicable	BayerRG8, BayerRG10, BayerRG10p, BayerRG12, BayerRG12p
<b>Pixel formats, other access modes</b>		
YUV color pixel formats	Not applicable	YUV422 8-bit (UYVY)
RGB color pixel formats	Default: RGB888 (RGB3)	
RAW pixel formats	RAW8 (GREY), RAW10 (Y10), RAW12 (Y12)	
Maximum frame rate	39 fps, using 4 lanes	
Maximum frame rate	39 fps, using 4 lanes	
Exposure time	11 μs to 10 s (4 lanes)	
Exposure modes	Timed, TriggerControlled, TriggerWidth	
Gain	0 dB to 48 dB; 0.1 dB increments	
Digital binning <sup>1</sup>	Horizontal: 1 to 8 columns; Vertical: 1 to 8 rows	
Sensor binning (H × V)	2 × 2 ( <i>Sum</i> )	Not applicable
Image buffer (RAM)	256 KByte	
Non-volatile memory (Flash)	1024 KByte	
GPIOs	2 programmable GPIOs As direct inputs (push-pull): 0 to 5.5 VDC As direct outputs (push-pull): 0 to 3.3 VDC at 12 mA	

<sup>1</sup> Digital vertical binning can be used only when digital horizontal binning is used as well.

Table 82: Alvium 1800 C-1242m/c specifications (sheet 1 of 2)

Feature	Specification			
	<b>1800 C-1242m/c</b>			
Power requirements	Power over MIPI CSI-2			
Power consumption (typical, at 5 VDC)	3.2 W			
Storage temperature	-20 °C to +85 °C ambient temperature			
<b>Operating temperature</b>	<b>Hardware option</b>	<b>Housing</b>	<b>Cooling area<sup>2</sup></b>	<b>Mainboard<sup>3</sup></b>
	Bare board <sup>4</sup>	Not applicable	-20 °C to +85 °C	-20 °C to +85 °C
	Open housing <sup>5</sup>	-20 °C to +65 °C		
Relative humidity	0% to 80% (non-condensing)			
Digital interface	MIPI CSI-2 D-PHY V1.1; 1, 2, or 4 lanes; maximum 1.051 Gbit/s per lane			
Camera controls	GenICam (GenICam for CSI-2 Access)			
	V4L2 controls (Video4Linux Access), Direct Register Access			
<sup>2</sup> See <a href="#">Mounting the heat sink</a> on page 256.				
<sup>3</sup> Output by DeviceTemperature				
<sup>4</sup> Ensure that the sensor is operated in the temperature range specified by the manufacturer. For any questions, please visit <a href="http://www.alliedvision.com/en/support">www.alliedvision.com/en/support</a> .				
<sup>5</sup> Temperature values must be observed for the housing <b>and</b> for the cooling area.				

Table 82: Alvium 1800 C-1242m/c specifications (sheet 2 of 2)

## Absolute QE

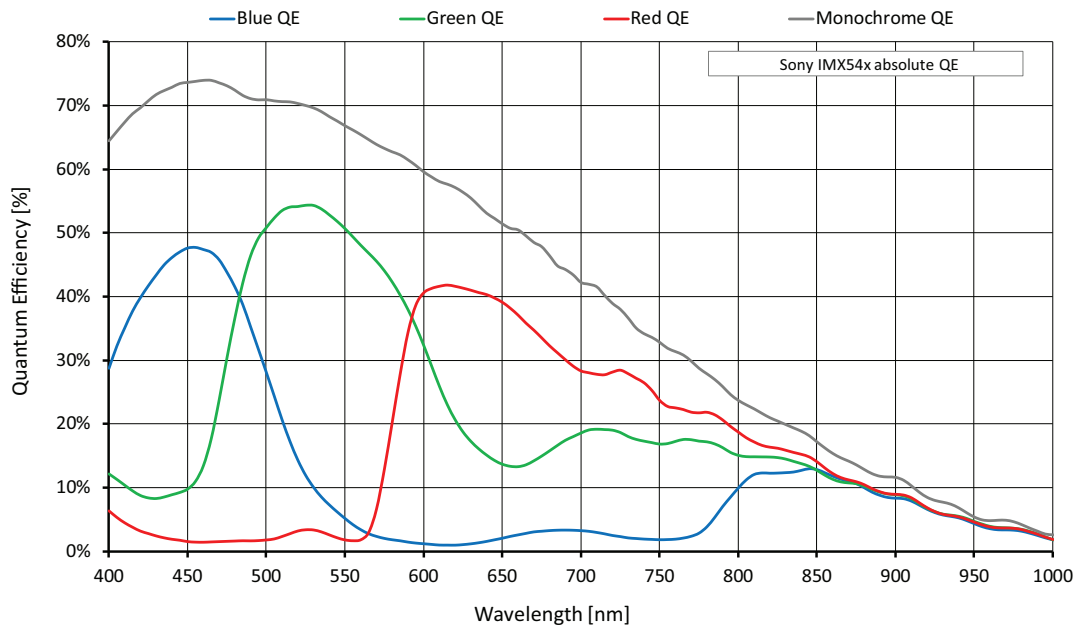

Figure 54: Alvium 1800 C-1242m/c (Sony IMX545) absolute QE

## Spectral response

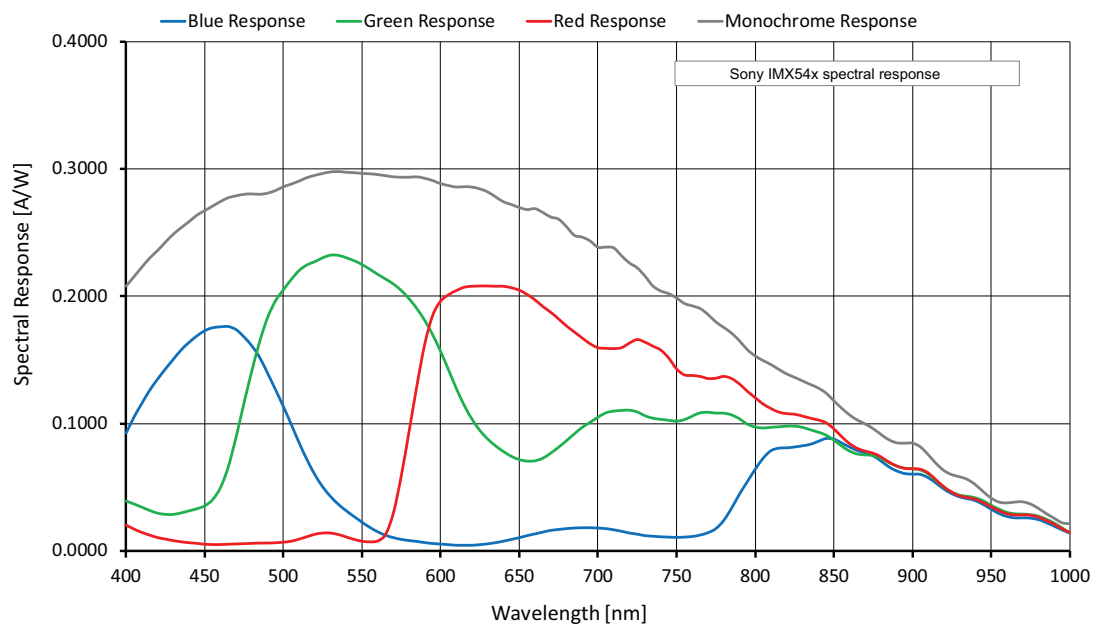

Figure 55: Alvium 1800 C-1242m/c (Sony IMX545) spectral response

## Frame rates with Cropping

Values were calculated as defined in [Frame rates with ROI/Cropping](#) on page 71 and in [Operation for maximum frame rates](#) on page 73.

Frame rates at maximum bandwidth calculates for 1.051 Gbit/s per lane. To reach the maximum frame rate available for typical operation, the bandwidth for image traffic is at 4 lanes with 4.204 Gbit/s.

Image format	Width [pixels]	Height [pixels]	ROI area [MP]	Frame rate [fps] <sup>1</sup>		
				4-lane	2-lane	1-lane
				4.204 Gbit/s	2.102 Gbit/s	1.051 Gbit/s
Full resolution	4128	3008	12.417	39.8	20.0	10.0
UHD 4K	3840	2160	8.294	55.8	29.4	14.8
QXGA	2560	2048	5.243	59.0	46.4	23.3
WQHD	2560	1440	3.686	81.4	64.1	32.2
QXGA	2048	1536	3.146	77.0	75.5	38.0
Full HD	1920	1080	2.074	105.5		55.5
UXGA	1600	1200	1.920	96.4		60.8
WXGA+ <sup>3</sup>	1440	904	1.302	123.6		86.4
SXGA	1280	1024	1.311	111.1		87.4
HD 720	1280	720	0.922	149.9		118.0
XGA	1024	768	0.786	142.5		139.6
SVGA	800	600	0.480	175.2		
VGA	640	480	0.307	209.1		
HVGA	480	320	0.154	281.7		
QVGA	320	240	0.077	340.4		
HQVGA	240	160	0.038	430.0		
QQVGA	160	120	0.019	495.1		
Max. × half	4128	1504	6.209	75.4	38.2	19.2
Max. × min.	4128	16	0.066	645.3	363.2	193.8
Min. × max.	16	3008	0.048	41.4		
Min. × min.	16	16	256 P	817.0		

<sup>1</sup> Mono8 or Bayer...8<sup>(2)</sup>, Mono10 or Bayer...10, or Mono12 or Bayer...12 at **SensorBitDepth** = 12-Bit

<sup>2</sup> The three dots... represent the colors of a Bayer pixel format, such as in Bayer**RG**8.

<sup>3</sup> Instead of 1440 × 900

If resolutions were not available due to increments, frame rates relate to the next available resolution.

Table 83: Alvium 1800 C-1242m/c ROI frame rates



## Alvium 1800 C-1620m/c

Red table border lines signal that **GeniCam for CSI-2 Access** is required.

Feature	Specification	
	1800 C-1620m (monochrome)	1800 C-1620c (color)
Sensor model	Sony IMX542	
Resolution	5328 (H) × 3040 (V); 16.2 MP	
Sensor type	CMOS	
Shutter type	Global shutter (GS)	
Sensor size	Type 1.1; 14.6 mm × 8.3 mm; 16.8 mm diagonal	
Pixel size	2.74 μm × 2.74 μm	
CRA	0 deg	
Sensor bit depth (ADC)	12-bit	
<b>Pixel formats, GeniCam for CSI-2 Access</b>		
Monochrome pixel formats	Mono8 (default), Mono10, Mono10p, Mono12, Mono12p	Mono8, Mono10, Mono10p, Mono12, Mono12p
YUV color pixel formats	Not applicable	YCbCr411_8_CbYYCrYY, YCbCr422_8_CbYCrY, YCbCr8_CbYCr
RGB color pixel formats	Not applicable	BGR8, RGB8 (default)
Raw color pixel formats	Not applicable	BayerRG8, BayerRG10, BayerRG10p, BayerRG12, BayerRG12p
<b>Pixel formats, other access modes</b>		
YUV color pixel formats	Not applicable	YUV422 8-bit (UYVY)
RGB color pixel formats	Default: RGB888 (RGB3)	
RAW pixel formats	RAW8 (GREY), RAW10 (Y10), RAW12 (Y12)	
Maximum frame rate	30 fps, using 4 lanes	
Maximum frame rate	30 fps, using 4 lanes	
Exposure time	13 μs to 10 s (4 lanes)	
Exposure modes	Timed, TriggerControlled, TriggerWidth	
Gain	0 dB to 48 dB; 0.1 dB increments	
Digital binning <sup>1</sup>	Horizontal: 1 to 8 columns; Vertical: 1 to 8 rows	
Sensor binning (H × V)	2 × 2 ( <i>Sum</i> )	Not applicable
Image buffer (RAM)	256 KByte	
Non-volatile memory (Flash)	1024 KByte	
GPIOs	2 programmable GPIOs As direct inputs (push-pull): 0 to 5.5 VDC As direct outputs (push-pull): 0 to 3.3 VDC at 12 mA	

<sup>1</sup> Digital vertical binning can be used only when digital horizontal binning is used as well.

Table 84: Alvium 1800 C-1620m/c specifications (sheet 1 of 2)

Feature	Specification			
	<b>1800 C-1620m/c</b>			
Power requirements	Power over MIPI CSI-2			
Power consumption (typical, at 5 VDC)	3.8 W			
Storage temperature	-20 °C to +85 °C ambient temperature			
<b>Operating temperature</b>	<b>Hardware option</b>	<b>Housing</b>	<b>Cooling area<sup>2</sup></b>	<b>Mainboard<sup>3</sup></b>
	Bare board <sup>4</sup>	Not applicable	-20 °C to +85 °C	-20 °C to +85 °C
	Open housing <sup>5</sup>	-20 °C to +65 °C		
Relative humidity	0% to 80% (non-condensing)			
Digital interface	MIPI CSI-2 D-PHY V1.1; 1, 2, or 4 lanes; maximum 1.051 Gbit/s per lane			
Camera controls	GenICam (GenICam for CSI-2 Access)			
	V4L2 controls (Video4Linux Access), Direct Register Access			
<sup>2</sup> See <a href="#">Mounting the heat sink</a> on page 256.				
<sup>3</sup> Output by <code>DeviceTemperature</code>				
<sup>4</sup> Ensure that the sensor is operated in the temperature range specified by the manufacturer. For any questions, please visit <a href="http://www.alliedvision.com/en/support">www.alliedvision.com/en/support</a> .				
<sup>5</sup> Temperature values must be observed for the housing <b>and</b> for the cooling area.				

Table 84: Alvium 1800 C-1620m/c specifications (sheet 2 of 2)

## Absolute QE

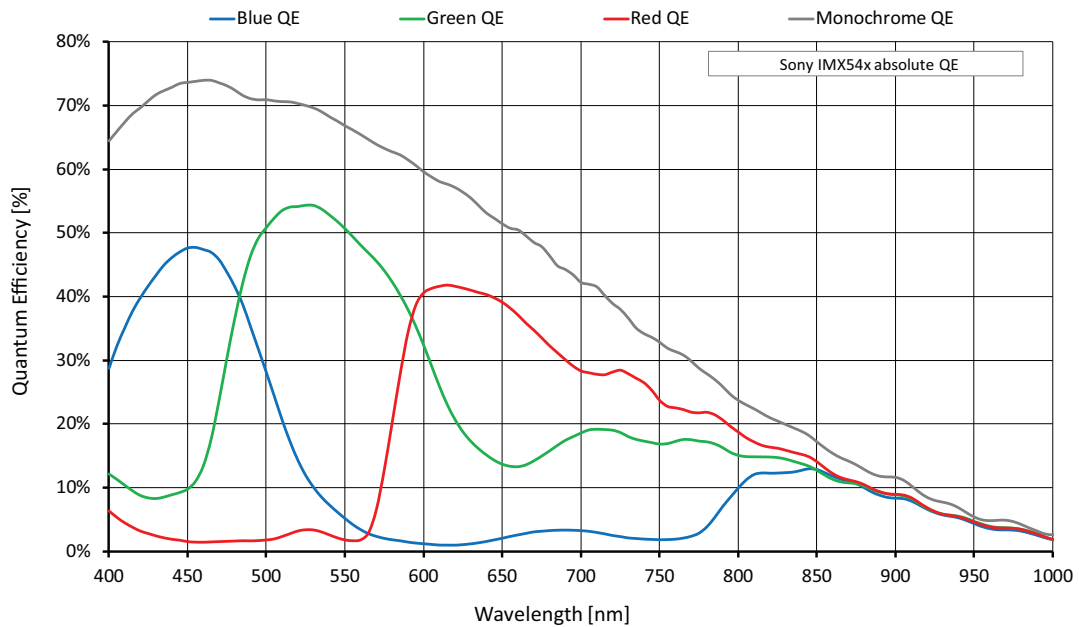

Figure 56: Alvium 1800 C-1620m/c (Sony IMX542) absolute QE

## Spectral response

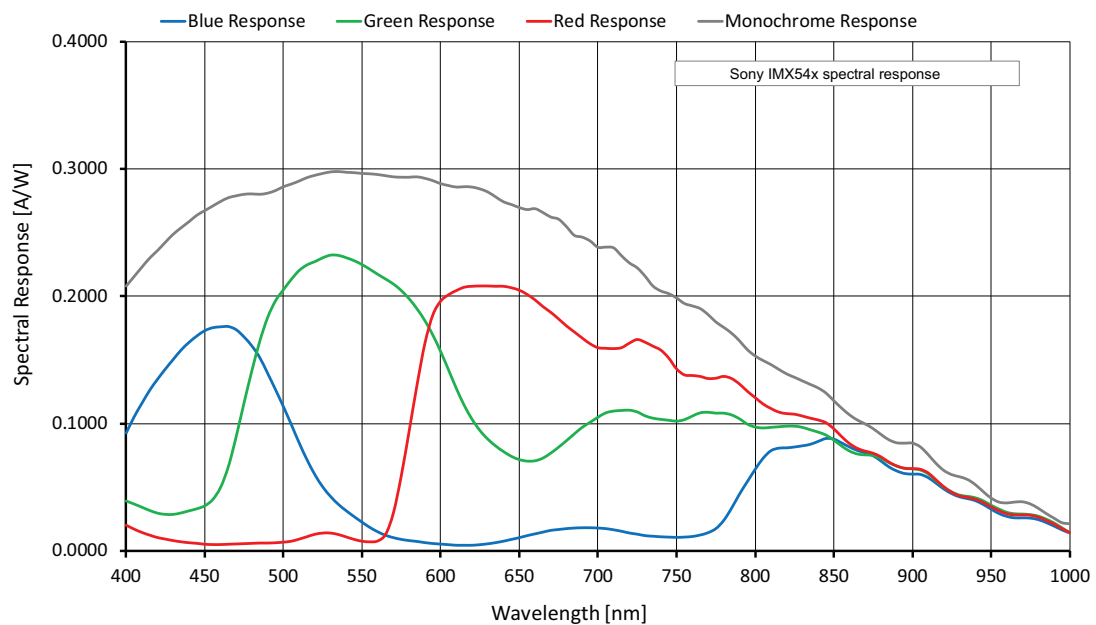

Figure 57: Alvium 1800 C-1620m/c (Sony IMX542) spectral response



## Frame rates with Cropping

Values were calculated as defined in [Frame rates with ROI/Cropping](#) on page 71 and in [Operation for maximum frame rates](#) on page 73.

Frame rates at maximum bandwidth calculates for 1.051 Gbit/s per lane. To reach the maximum frame rate available for typical operation, the bandwidth for image traffic is at 4 lanes with 4.204 Gbit/s.

Image format	Width [pixels]	Height [pixels]	ROI area [MP]	Frame rate [fps] <sup>1</sup>		
				4-lane	2-lane	1-lane
				4.204 Gbit/s	2.102 Gbit/s	1.051 Gbit/s
Full resolution	5328	3040	16.148	30.8	15.5	7.8
UHD 4K	3840	2160	8.294	44.6	29.6	14.9
QXGA	2560	2048	5.243	47.1	46.8	23.5
WQHD	2560	1440	3.686	65.2	64.9	32.7
QXGA	2048	1536	3.146	61.7		38.4
Full HD	1920	1080	2.074	84.9		56.4
UXGA	1600	1200	1.920	77.4		61.8
WXGA+ <sup>3</sup>	1440	904	1.302	99.7		88.0
SXGA	1280	1024	1.311	89.4		88.9
HD 720	1280	720	0.922	121.4		120.8
XGA	1024	768	0.786	115.3		
SVGA	800	600	0.480	142.2		
VGA	640	480	0.307	171.0		
HVGA	480	320	0.154	232.7		
QVGA	320	240	0.077	284.0		
HQVGA	240	160	0.038	364.4		
QQVGA	160	120	0.019	424.3		
Max. × half	5312	1520	8.074	58.7	29.7	15.0
Max. × min.	5312	16	0.085	557.8	318.5	171.6
Min. × max.	16	3040	0.049	32.6		
Min. × min.	16	16	256 P	741.9		

<sup>1</sup> Mono8 or Bayer...8<sup>(2)</sup>, Mono10 or Bayer...10, or Mono12 or Bayer...12 at **SensorBitDepth** = 12-Bit  
<sup>2</sup> The three dots... represent the colors of a Bayer pixel format, such as in Bayer**RG8**.  
<sup>3</sup> Instead of 1440 × 900  
 If resolutions were not available due to increments, frame rates relate to the next available resolution.

Table 85: Alvium 1800 C-1620m/c ROI frame rates



## Alvium 1800 C-2040m/c

Red table border lines signal that **GeniCam for CSI-2 Access** is required.

Feature	Specification	
	1800 C-2040m (monochrome)	1800 C-2040c (color)
Sensor model	Sony IMX541	
Resolution	4512 (H) × 4512 (V); 20.4 MP	
Sensor type	CMOS	
Shutter type	Global shutter (GS)	
Sensor size	Type 1.1; 12.4 mm × 12.4 mm; 17.5 mm diagonal	
Pixel size	2.74 μm × 2.74 μm	
CRA	0 deg	
Sensor bit depth (ADC)	12-bit	
<b>Pixel formats, GeniCam for CSI-2 Access</b>		
Monochrome pixel formats	Mono8 (default), Mono10, Mono10p, Mono12, Mono12p	Mono8, Mono10, Mono10p, Mono12, Mono12p
YUV color pixel formats	Not applicable	YCbCr411_8_CbYYCrYY, YCbCr422_8_CbYCrY, YCbCr8_CbYCr
RGB color pixel formats	Not applicable	BGR8, RGB8 (default)
Raw color pixel formats	Not applicable	BayerRG8, BayerRG10, BayerRG10p, BayerRG12, BayerRG12p
<b>Pixel formats, other access modes</b>		
YUV color pixel formats	Not applicable	YUV422 8-bit (UYVY)
RGB color pixel formats	Default: RGB888 (RGB3)	
RAW pixel formats	RAW8 (GREY), RAW10 (Y10), RAW12 (Y12)	
Maximum frame rate	24 fps, using 4 lanes	
Maximum frame rate	24 fps, using 4 lanes	
Exposure time	12 μs to 10 s (4 lanes)	
Exposure modes	Timed, TriggerControlled, TriggerWidth	
Gain	0 dB to 48 dB; 0.1 dB increments	
Digital binning <sup>1</sup>	Horizontal: 1 to 8 columns; Vertical: 1 to 8 rows	
Sensor binning (H × V)	2 × 2 ( <i>Sum</i> )	Not applicable
Image buffer (RAM)	256 KByte	
Non-volatile memory (Flash)	1024 KByte	
GPIOs	2 programmable GPIOs As direct inputs (push-pull): 0 to 5.5 VDC As direct outputs (push-pull): 0 to 3.3 VDC at 12 mA	
<sup>1</sup> Digital vertical binning can be used only when digital horizontal binning is used as well.		

Table 86: Alvium 1800 C-2040m/c specifications (sheet 1 of 2)

Feature	Specification			
	<b>1800 C-2040m/c</b>			
Power requirements	Power over MIPI CSI-2			
Power consumption (typical, at 5 VDC)	3.7 W			
Storage temperature	-20 °C to +85 °C ambient temperature			
<b>Operating temperature</b>	<b>Hardware option</b>	<b>Housing</b>	<b>Cooling area<sup>2</sup></b>	<b>Mainboard<sup>3</sup></b>
	Bare board <sup>4</sup>	Not applicable	-20 °C to +85 °C	-20 °C to +85 °C
	Open housing <sup>5</sup>	-20 °C to +65 °C		
Relative humidity	0% to 80% (non-condensing)			
Digital interface	MIPI CSI-2 D-PHY V1.1; 1, 2, or 4 lanes; maximum 1.051 Gbit/s per lane			
Camera controls	GenICam (GenICam for CSI-2 Access)			
	V4L2 controls (Video4Linux Access), Direct Register Access			
<sup>2</sup> See <a href="#">Mounting the heat sink</a> on page 256.				
<sup>3</sup> Output by DeviceTemperature				
<sup>4</sup> Ensure that the sensor is operated in the temperature range specified by the manufacturer. For any questions, please visit <a href="http://www.alliedvision.com/en/support">www.alliedvision.com/en/support</a> .				
<sup>5</sup> Temperature values must be observed for the housing <b>and</b> for the cooling area.				

Table 86: Alvium 1800 C-2040m/c specifications (sheet 2 of 2)

## Absolute QE

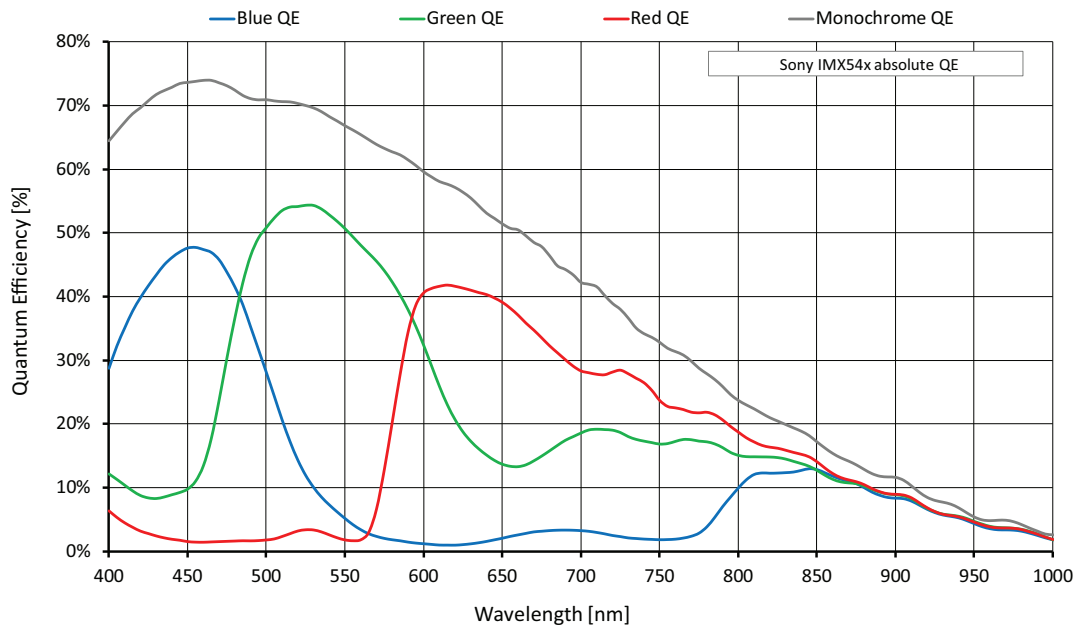

Figure 58: Alvium 1800 C-2040m/c (Sony IMX541) absolute QE

## Spectral response

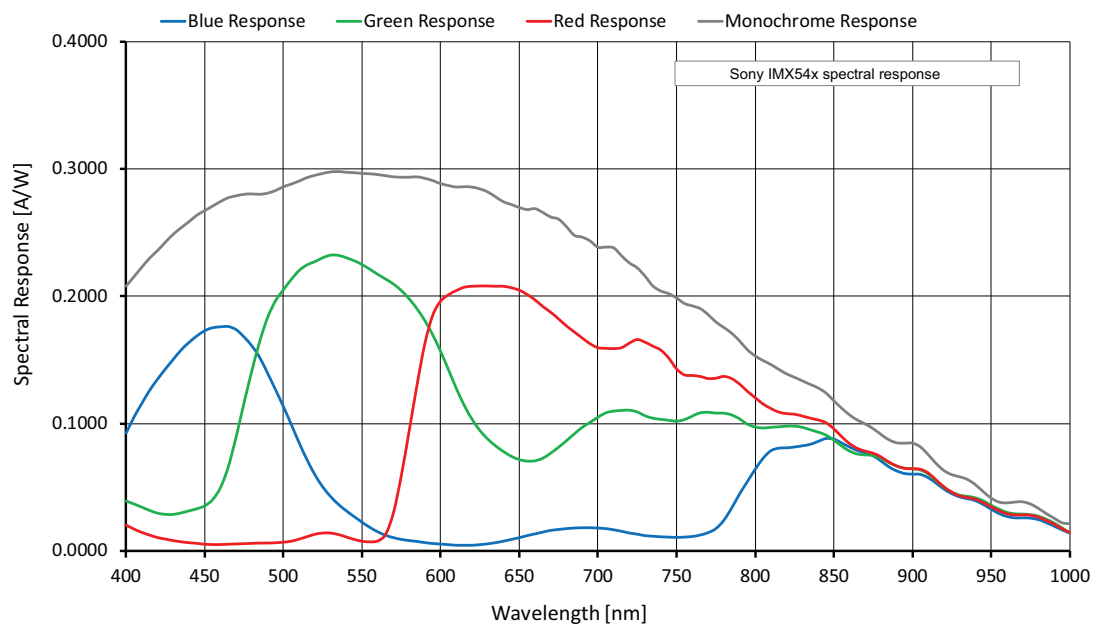

Figure 59: Alvium 1800 C-2040m/c (Sony IMX541) spectral response

## Frame rates with Cropping

Values were calculated as defined in [Frame rates with ROI/Cropping](#) on page 71 and in [Operation for maximum frame rates](#) on page 73.

Frame rates at maximum bandwidth calculates for 1.051 Gbit/s per lane. To reach the maximum frame rate available for typical operation, the bandwidth for image traffic is at 4 lanes with 4.204 Gbit/s.

Image format	Width [pixels]	Height [pixels]	ROI area [MP]	Frame rate [fps] <sup>1</sup>		
				4-lane	2-lane	1-lane
				4.204 Gbit/s	2.102 Gbit/s	1.051 Gbit/s
Full resolution	4512	4512	20.358	24.8	12.5	6.2
HXGA	4096	3072	12.583	37.2	19.9	10.0
UHD 4K	3840	2160	8.294	52.0	29.6	14.9
QSXGA	2560	2048	5.243	54.9	46.8	23.5
WQHD	2560	1440	3.686	76.0	64.8	32.6
QXGA	2048	1536	3.146	71.9		38.4
Full HD	1920	1080	2.074	98.8		56.4
UXGA	1600	1200	1.920	90.2		61.7
WXGA+ <sup>3</sup>	1440	904	1.302	116.1		87.9
SXGA	1280	1024	1.311	104.1		88.7
HD 720	1280	720	0.922	141.3		120.5
XGA	1024	768	0.786	134.2		
SVGA	800	600	0.480	165.5		
VGA	640	480	0.307	198.9		
HVGA	480	320	0.154	270.2		
QVGA	320	240	0.077	329.3		
HQVGA	240	160	0.038	421.4		
QQVGA	160	120	0.019	489.9		
Max. × half	4512	2256	10.179	47.9	24.2	12.1
Max. × min.	4512	16	0.072	648.1	370.6	199.2
Min. × max.	16	4512	0.072	25.9		
Min. × min.	16	16	256 P	848.8		

<sup>1</sup> Mono8 or Bayer...8<sup>(2)</sup>, Mono10 or Bayer...10, or Mono12 or Bayer...12 at SensorBitDepth = 12-Bit  
<sup>2</sup> The three dots... represent the colors of a Bayer pixel format, such as in BayerRG8.  
<sup>3</sup> Instead of 1440 × 900  
 If resolutions were not available due to increments, frame rates relate to the next available resolution.

Table 87: Alvium 1800 C-2040m/c ROI frame rates



## Alvium 1800 C-2050m/c

Red table border lines signal that **GenICam for CSI-2 Access** is required.

Feature	Specification	
	1800 C-2050m (monochrome)	1800 C-2050c (color)
Sensor model	Sony IMX183	
Resolution	5496 (H) × 3672 (V); 20.2 MP	
Sensor type	CMOS	
Shutter type	Rolling shutter (RS), Global reset shutter (GRS)	
Sensor size	Type 1; 13.1 mm × 8.8 mm; 15.9 mm diagonal	
Pixel size	2.4 μm × 2.4 μm	
CRA	3 deg	
ADC bit depth	10-bit	
<b>Pixel formats, GenICam for CSI-2 Access</b>		
Monochrome pixel formats	Mono8 (default), Mono10, Mono10p, Mono12, Mono12p	Mono8, Mono10, Mono10p, Mono12, Mono12p
YUV color pixel formats	Not applicable	YCbCr411_8_CbYYCrYY, YCbCr422_8_CbYCrY, YCbCr8_CbYCr
RGB color pixel formats	Not applicable	BGR8, RGB8 (default)
Raw color pixel formats	Not applicable	BayerRG8, BayerRG10, BayerRG10p, BayerRG12, BayerRG12p
<b>Pixel formats, other access modes</b>		
YUV color pixel formats	Not applicable	YUV422 8-bit (UYVY)
RGB color pixel formats	Default: RGB888 (RGB3)	
RAW pixel formats	RAW8 (GREY), RAW10 (Y10)	
Maximum frame rate	25 fps <sup>1</sup> , using 4 lanes	
Maximum frame rate	25 fps <sup>1</sup> , using 4 lanes	
Exposure time	13 μs to 10 s (4 lanes)	
Exposure modes	Timed	
Gain	0 dB to 27 dB; 0.1 dB increments	
Digital binning <sup>2</sup>	Horizontal: 1 to 8 columns; Vertical: 1 to 8 rows	
Image buffer (RAM)	256 KByte	
Non-volatile memory (Flash)	1024 KByte	
GPIOs	2 programmable GPIOs As direct inputs (push-pull): 0 to 5.5 VDC As direct outputs (push-pull): 0 to 3.3 VDC at 12 mA	
<sup>1</sup> In triggered mode: ~25 fps		
<sup>2</sup> Digital vertical binning can be used only when digital horizontal binning is used as well.		

Table 88: Alvium 1800 C-2050m/c specifications (sheet 1 of 2)

Feature	Specification			
	<b>1800 C-2050m/c</b>			
Power requirements	Power over MIPI CSI-2			
Power consumption (typical, at 5 VDC)	2.9 W			
Storage temperature	-20 °C to +85 °C ambient temperature			
<b>Operating temperature</b>	<b>Hardware option</b>	<b>Housing</b>	<b>Cooling area<sup>3</sup></b>	<b>Mainboard<sup>4</sup></b>
	Bare board <sup>5</sup>	Not applicable	-20 °C to +85 °C	-20 °C to +88 °C
	Open housing <sup>6</sup>	-20 °C to +65 °C		
Relative humidity	0% to 80% (non-condensing)			
Digital interface	MIPI CSI-2 D-PHY V1.1; 1, 2, or 4 lanes; maximum 1.051 Gbit/s per lane			
Camera controls	GenICam (GenICam for CSI-2 Access)			
	V4L2 controls (Video4Linux Access), Direct Register Access			
<sup>3</sup> See <a href="#">Mounting the heat sink</a> on page 256.				
<sup>4</sup> Output by <code>DeviceTemperature</code>				
<sup>5</sup> Ensure that the sensor is operated in the temperature range specified by the manufacturer. For any questions, please visit <a href="http://www.alliedvision.com/en/support">www.alliedvision.com/en/support</a> .				
<sup>6</sup> Temperature values must be observed for the housing <b>and</b> for the cooling area.				

Table 88: Alvium 1800 C-2050m/c specifications (sheet 2 of 2)

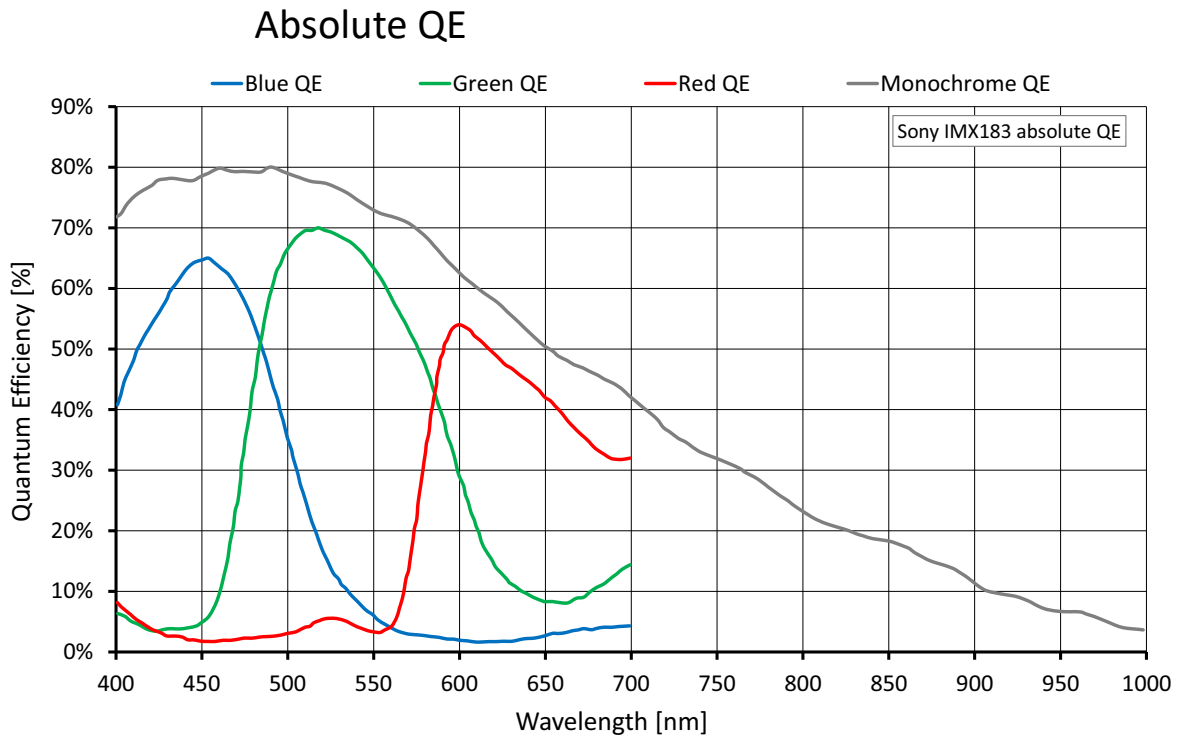

Figure 60: Alvium 1800 C-2050m/c (Sony IMX183) absolute QE

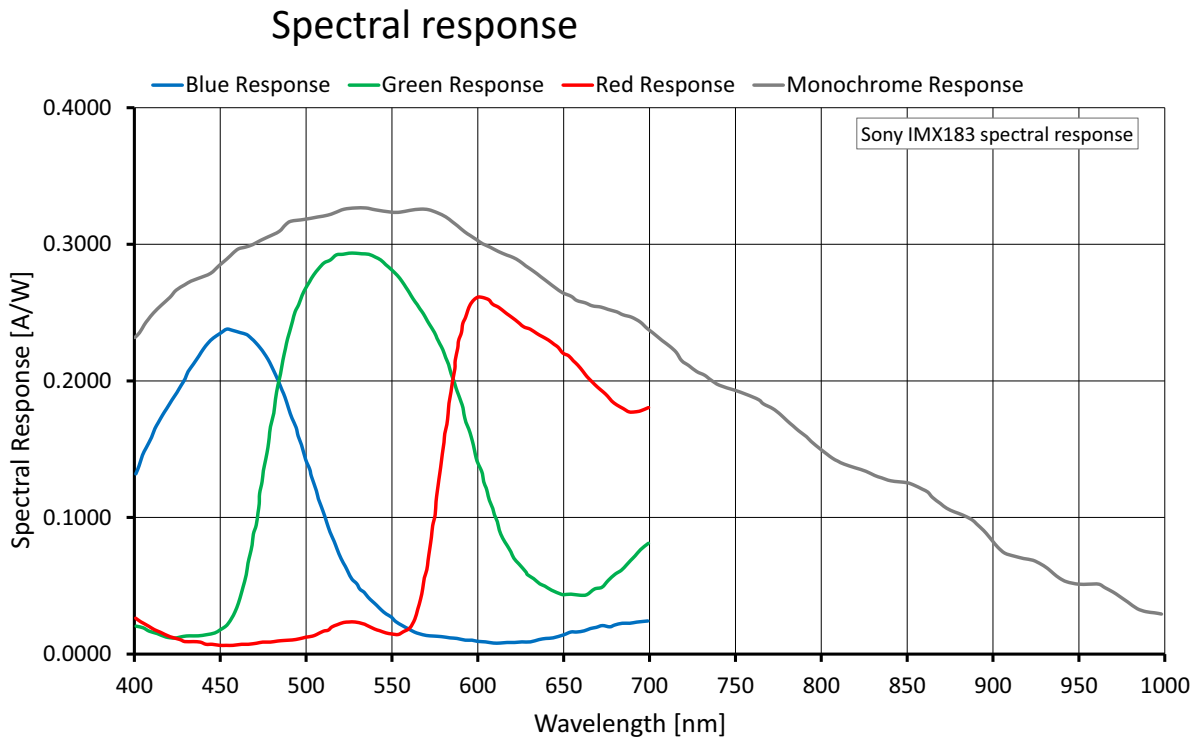

Figure 61: Alvium 1800 C-2050m/c (Sony IMX183) spectral response



## Frame rates with Cropping

Values were calculated as defined in [Frame rates with ROI/Cropping](#) on page 71 and in [Operation for maximum frame rates](#) on page 73.

Frame rates at maximum bandwidth calculates for 1.051 Gbit/s per lane. To reach the maximum frame rate available for typical operation, the bandwidth for image traffic is at 4 lanes with 4.204 Gbit/s.

Shutter mode	User mode	Available frame rates
Rolling shutter (RS)	Freerun	Values in <a href="#">Table 90</a> below are reached.
Rolling shutter (RS)	Triggered	>99% of the values for in <a href="#">Table 90</a> below are reached.
Global reset shutter (GRS)	Freerun	>99% of the values for in <a href="#">Table 90</a> below are reached.
Global reset shutter (GRS)	Triggered	>99% of the values for in <a href="#">Table 90</a> below are reached.

Table 89: Frame rate behavior for different configurations

Image format	Width [pixels]	Height [pixels]	ROI area [MP]	Frame rate [fps] <sup>1</sup>		
				4-lane	2-lane	1-lane
				4.204 Gbit/s	2.102 Gbit/s	1.051 Gbit/s
Full resolution <sup>3</sup>	5496	3672	20.181	25.1	12.7	6
HXGA	4096	3072	12.583	29.9	15.1	7
UHD 4K	3840	2160	8.294	41.8	21.1	10.7
QSXGA	2560	2048	5.243	43.9	22.3	11.2
WQHD	2560	1440	3.686	48.4	24.6	12.4
QXGA	2048	1536	3.146			
Full HD	1920	1080	2.074			
UXGA	1600	1200	1.920			
WXGA+ <sup>4</sup>	1440	904	1.302			
SXGA	1280	1024	1.311			
...	...	...	...			
QVGA	320	240	0.077			
HQVGA	240	160	0.038			
QQVGA	160	120	0.019			
Max. × half <sup>5</sup>	5376	1840	9.892	25.1	12.7	6
Max. × min.	5376	16	0.086			
Min. × max.	16	3672	0.059			
Min. × min.	16	16	256 P	48.4	24.6	12.4

<sup>1</sup> Mono8 or Bayer...8<sup>(2)</sup>, Mono10 or Bayer...10, or Mono12 or Bayer...12 at **SensorBitDepth** = 10-Bit

<sup>2</sup> The three dots... represent the colors of a Bayer pixel format, such as in BayerRG8.

<sup>3</sup> 5376 × 3672 with Video4Linux Access or Direct Register Access.

<sup>4</sup> Instead of 1440 × 900 | <sup>5</sup> Instead of 5376 × 1836

If resolutions were not available due to increments, frame rates relate to the next available resolution.

Table 90: Alvim 1800 C-2050m/c ROI frame rates



## Alvium 1800 C-2460m/c

Red table border lines signal that **GeniCam for CSI-2 Access** is required.

Feature	Specification	
	1800 C-2460m (monochrome)	1800 C-2460c (color)
Sensor model	Sony IMX540	
Resolution	5328 (H) × 4608 (V); 24.6 MP	
Sensor type	CMOS	
Shutter type	Global shutter (GS)	
Sensor size	Type 1.2; 14.6 mm × 12.6 mm; 19.3 mm diagonal	
Pixel size	2.74 μm × 2.74 μm	
CRA	0 deg	
Sensor bit depth (ADC)	12-bit	
<b>Pixel formats, GeniCam for CSI-2 Access</b>		
Monochrome pixel formats	Mono8 (default), Mono10, Mono10p, Mono12, Mono12p	Mono8, Mono10, Mono10p, Mono12, Mono12p
YUV color pixel formats	Not applicable	YCbCr411_8_CbYYCrYY, YCbCr422_8_CbYCrY, YCbCr8_CbYCr
RGB color pixel formats	Not applicable	BGR8, RGB8 (default)
Raw color pixel formats	Not applicable	BayerRG8, BayerRG10, BayerRG10p, BayerRG12, BayerRG12p
<b>Pixel formats, other access modes</b>		
YUV color pixel formats	Not applicable	YUV422 8-bit (UYVY)
RGB color pixel formats	Default: RGB888 (RGB3)	
RAW pixel formats	RAW8 (GREY), RAW10 (Y10), RAW12 (Y12)	
Maximum frame rate	20 fps, using 4 lanes	
Maximum frame rate	20 fps, using 4 lanes	
Exposure time	13 μs to 10 s (4 lanes)	
Exposure modes	Timed, TriggerControlled, TriggerWidth	
Gain	0 dB to 48 dB; 0.1 dB increments	
Digital binning <sup>1</sup>	Horizontal: 1 to 8 columns; Vertical: 1 to 8 rows	
Sensor binning (H × V)	2 × 2 ( <i>Sum</i> )	Not applicable
Image buffer (RAM)	256 KByte	
Non-volatile memory (Flash)	1024 KByte	
GPIOs	2 programmable GPIOs As direct inputs (push-pull): 0 to 5.5 VDC As direct outputs (push-pull): 0 to 3.3 VDC at 12 mA	

<sup>1</sup> Digital vertical binning can be used only when digital horizontal binning is used as well.

Table 91: Alvium 1800 C-2460m/c specifications (sheet 1 of 2)

Feature	Specification			
	<b>1800 C-2460m/c</b>			
Power requirements	Power over MIPI CSI-2			
Power consumption (typical, at 5 VDC)	3.8 W			
Storage temperature	-20 °C to +85 °C ambient temperature			
<b>Operating temperature</b>	<b>Hardware option</b>	<b>Housing</b>	<b>Cooling area<sup>2</sup></b>	<b>Mainboard<sup>3</sup></b>
	Bare board <sup>4</sup>	Not applicable	-20 °C to +85 °C	-20 °C to +85 °C
	Open housing <sup>5</sup>	-20 °C to +65 °C		
Relative humidity	0% to 80% (non-condensing)			
Digital interface	MIPI CSI-2 D-PHY V1.1; 1, 2, or 4 lanes; maximum 1.051 Gbit/s per lane			
Camera controls	GenICam (GenICam for CSI-2 Access)			
	V4L2 controls (Video4Linux Access), Direct Register Access			
<sup>2</sup> See <a href="#">Mounting the heat sink</a> on page 256.				
<sup>3</sup> Output by <code>DeviceTemperature</code>				
<sup>4</sup> Ensure that the sensor is operated in the temperature range specified by the manufacturer. For any questions, please visit <a href="http://www.alliedvision.com/en/support">www.alliedvision.com/en/support</a> .				
<sup>5</sup> Temperature values must be observed for the housing <b>and</b> for the cooling area.				

Table 91: Alvium 1800 C-2460m/c specifications (sheet 2 of 2)

## Absolute QE

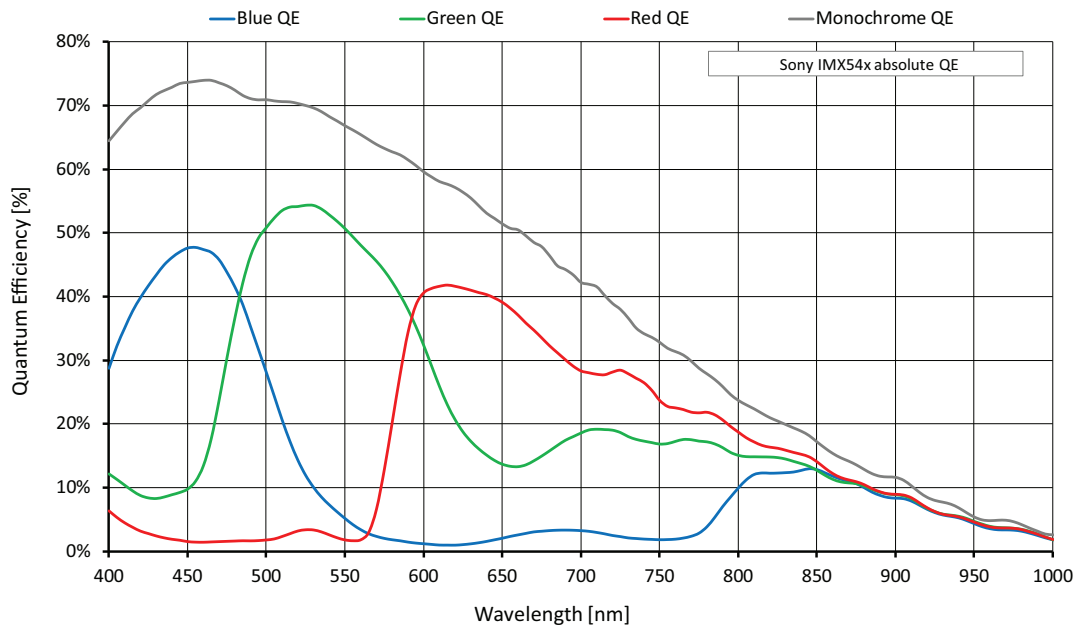

Figure 62: Alvium 1800 C-2460m/c (Sony IMX540) absolute QE

## Spectral response

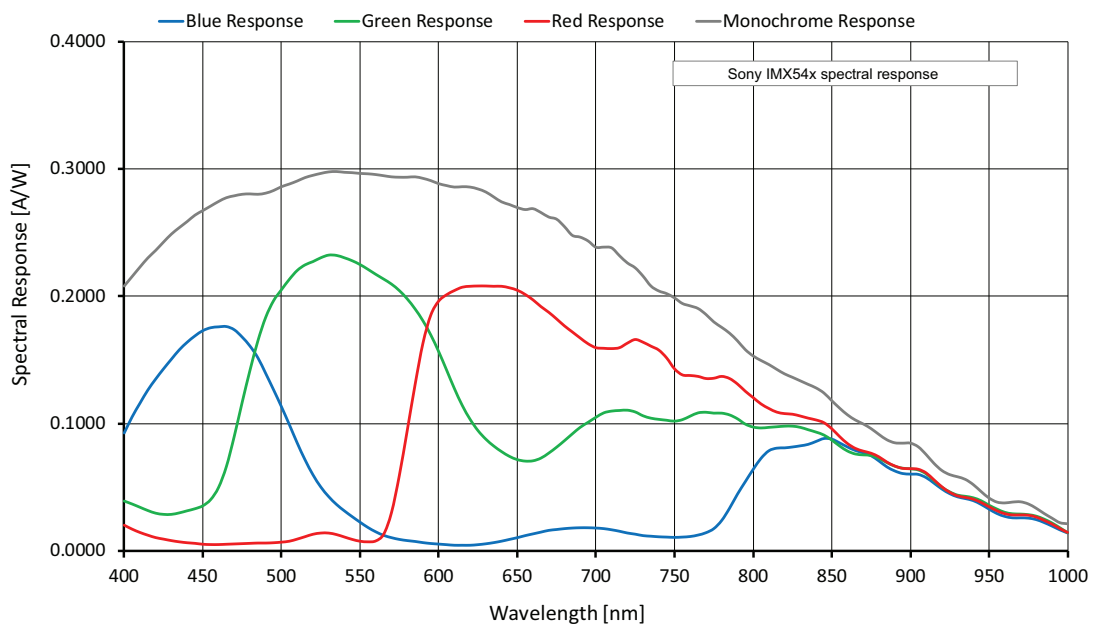

Figure 63: Alvium 1800 C-2460m/c (Sony IMX540) spectral response

## Frame rates with Cropping

Values were calculated as defined in [Frame rates with ROI/Cropping](#) on page 71 and in [Operation for maximum frame rates](#) on page 73.

Frame rates at maximum bandwidth calculates for 1.051 Gbit/s per lane. To reach the maximum frame rate available for typical operation, the bandwidth for image traffic is at 4 lanes with 4.204 Gbit/s.

Image format	Width [pixels]	Height [pixels]	ROI area [MP]	Frame rate [fps] <sup>1</sup>		
				4-lane	2-lane	1-lane
				4.204 Gbit/s	2.102 Gbit/s	1.051 Gbit/s
Full resolution	5328	4608	24.551	20.5	10.3	5.2
HSXGA	5120	4096	20.972	24.0	12.1	6.0
HXGA	4096	3072	12.583	31.9	19.9	10.0
UHD 4K	3840	2160	8.294	44.6	29.6	14.9
QSXGA	2560	2048	5.243	47.1	46.8	23.5
WQHD	2560	1440	3.686	65.2	64.9	32.7
QXGA	2048	1536	3.146	61.7		38.4
Full HD	1920	1080	2.074	84.9		56.4
UXGA	1600	1200	1.920	77.4		61.8
WXGA+ <sup>3</sup>	1440	904	1.302	99.7		88.0
SXGA	1280	1024	1.311	89.4		88.9
HD 720	1280	720	0.922	121.4		120.8
XGA	1024	768	0.786	115.3		
SVGA	800	600	0.480	142.2		
VGA	640	480	0.307	171.0		
HVGA	480	320	0.154	232.7		
QVGA	320	240	0.077	284.0		
HQVGA	240	160	0.038	364.4		
QQVGA	160	120	0.019	424.3		
Max. × half	5328	2304	12.276	39.8	20.1	10.1
Max. × min.	5328	16	0.085	554.8	317.6	171.1
Min. × max.	16	4608	0.074	21.8		
Min. × min.	16	16	256 P	741.9		

<sup>1</sup> Mono8 or Bayer...8<sup>(2)</sup>, Mono10 or Bayer...10, or Mono12 or Bayer...12 at **SensorBitDepth** = 12-Bit

<sup>2</sup> The three dots... represent the colors of a Bayer pixel format, such as in Bayer**RG8**.

<sup>3</sup> Instead of 1440 × 900

If resolutions were not available due to increments, frame rates relate to the next available resolution.

Table 92: Alvium 1800 C-2460m/c ROI frame rates

## White balance default

Alvium color cameras are balanced for neutral color reproduction with an illumination of 5000 °K (warm daylight). [Table 93](#) shows default values for the red and blue channel by model.

For different illuminations, use auto white balance or adapt the color channel values manually. See the descriptions in [Access modes](#) on page 246 for details.



### Excluded models

White balance default does not apply to monochrome and Pol models.

Alvium model	Sensor model	Red channel value	Blue channel value
1500 C-050c	ON Semiconductor PYTHON 480	1.930	1.500
1500 C-120c	ON Semiconductor AR0135CS	1.760	1.650
1500 C-210c	ON Semiconductor AR0521SR	2.120	1.520
1500 C-500c	ON Semiconductor AR0521SR	2.120	1.520
1500 C-501c NIR	ON Semiconductor AR0522	1.500	1.770
1800 C-040c	Sony IMX287	2.360	2.030
1800 C-052c	Sony IMX426	2.290	2.000
1800 C-158c	Sony IMX273	2.355	2.100
1800 C-203c	Sony IMX422	2.290	2.000
1800 C-234c	Sony IMX249	2.580	1.810
1800 C-235c	Sony IMX174	2.580	1.810
1800 C-240c	Sony IMX392	2.355	2.100
1800 C-291c	Sony IMX421	2.290	2.000
1800 C-319c	Sony IMX265	2.355	2.100
1800 C-500c	ON Semiconductor AR0521SR	2.120	1.520
1800 C-507c	Sony IMX264	2.355	2.100
1800 C-507c Pol	Sony IMX264MYR	Not applicable	
1800 C-508c	Sony IMX250	2.355	2.100
1800 C-508c Pol	Sony IMX250MYR	Not applicable	
1800 C-510c	Sony IMX548	2.870	2.000
1800 C-511c	Sony IMX547	2.870	2.000
1800 C-811c	Sony IMX546	2.870	2.000
1800 C-895c	Sony IMX267	2.355	2.100
1800 C-1236c	Sony IMX304	2.355	2.100

Table 93: Alvium default values for color channels (sheet 1 of 2)

Alvium model	Sensor model	Red channel value	Blue channel value
1800 C-1240c	Sony IMX226	2.620	1.810
1800 C-1242c	Sony IMX545	2.870	2.000
1800 C-1620c	Sony IMX542	2.870	2.000
1800 C-2040c	Sony IMX541	2.870	2.000
1800 C-2050c	Sony IMX183	2.660	1.830
1800 C-2460c	Sony IMX540	2.870	2.000

Table 93: Alvium default values for color channels (sheet 2 of 2)

## Standard Alvium: Dimensions and mass

Bare board cameras	Specification
Dimensions (L × W × H)	[Model specific] × 26 mm × 26 mm
Mass [g]	10 g

Table 94: Standard Alvium bare board dimensions and mass

Open housing cameras	C-Mount	CS-Mount	S-Mount
Flange focal distance, optical	17.526 mm	12.526 mm	12.63 mm
Thread	1"-32tpi UNS-2B	1"-32tpi UNS-2B	M12 mm × 0.5 mm
Maximum protrusion <sup>1</sup>	13.6 mm	8.6 mm	11.0 mm
Body dimensions (L × W × H) in [mm]	26 × 29 × 29	21 × 29 × 29	20 × 29 × 29
Mass	40 g	40 g	40 g

<sup>1</sup>For details, see [Maximum protrusion for front mounts](#).

Table 95: Standard Alvium housing dimensions and mass

# Standard Alvium: Technical drawings

Standard Alvium CSI-2 cameras are available with the following housing options:

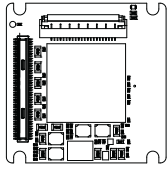
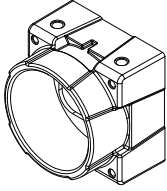
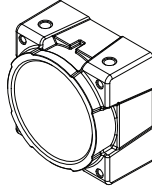
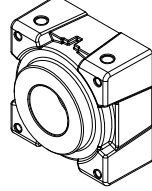
				
<b>Option</b>	Bare Board	Open Housing C-Mount	Open Housing CS-Mount	Open Housing S-Mount
<b>Page</b>	<a href="#">208</a>	<a href="#">210</a>	<a href="#">211</a>	<a href="#">212</a>

## Bare Board (standard Alvium)

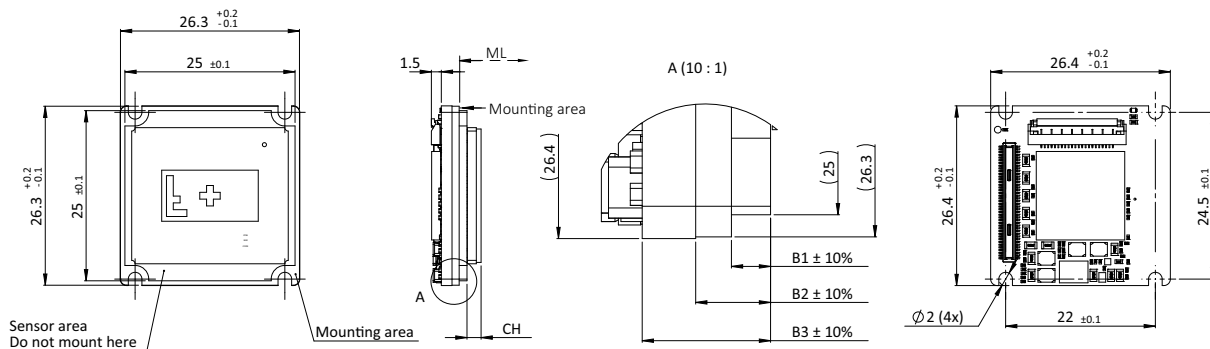

Figure 64: Bare Board (standard Alvium) dimensions

Dimensions that are common between different models are shown in [Figure 64](#), model specific dimensions are listed in [Table 96](#). **Mechanical length (ML)** defines the mechanical distance from the mounting area to the lens mount front flange, without optical filter. **Components height (CH)** relates to the electronic components with maximum height, sometimes the sensor.



### Mechanical length for S-Mount and CS-Mount

Mechanical length for other mounts is:

- CS-Mount: [C-Mount value] – 5 mm
- S-Mount: depending on your design.



Camera model	ML: Mechanical length* for C-Mount	CH: Components height, incl. the sensor	B1: Board thickness	B2: Board thickness	B3: Board thickness
Alvium 1500 C-050m/c	19.604 mm	1.40 mm	1.75 mm	3.00 mm	4.55 mm
Alvium 1500 C-120m/c	19.689 mm	1.44 mm	1.25 mm	2.40 mm	3.95 mm
Alvium 1500 C-210m/c	19.739 mm	1.67 mm	1.30 mm	2.40 mm	3.95 mm
Alvium 1500 C-500m/c	19.739 mm	1.67 mm	1.30 mm	2.40 mm	3.95 mm
Alvium 1500 C-501m/c NIR	19.739 mm	1.67 mm	1.30 mm	2.40 mm	3.95 mm
Alvium 1800 C-030 VSWIR	19.613 mm	2.87 mm	1.25 mm	2.20 mm	3.75 mm
Alvium 1800 C-040m/c	19.879 mm	2.27 mm	1.20 mm	2.20 mm	3.75 mm
Alvium 1800 C-052m/c	19.713 mm	2.87 mm	1.10 mm	2.20 mm	3.75 mm
Alvium 1800 C-130 VSWIR	19.613 mm	2.87 mm	1.25 mm	2.20 mm	3.75 mm
Alvium 1800 C-158m/c	19.879 mm	2.27 mm	1.20 mm	2.20 mm	3.75 mm
Alvium 1800 C-203m/c	19.713 mm	2.87 mm	1.10 mm	2.20 mm	3.75 mm
Alvium 1800 C-234m/c	19.713 mm	2.87 mm	1.10 mm	2.20 mm	3.75 mm
Alvium 1800 C-235m/c	19.713 mm	2.87 mm	1.10 mm	2.20 mm	3.75 mm
Alvium 1800 C-240m/c	19.929 mm	2.27 mm	1.25 mm	2.20 mm	3.75 mm
Alvium 1800 C-291m/c	19.713 mm	2.87 mm	1.10 mm	2.20 mm	3.75 mm
Alvium 1800 C-319m/c	19.929 mm	2.27 mm	1.25 mm	2.20 mm	3.75 mm
Alvium 1800 C-320 VSWIR	19.713 mm	2.83 mm	1.10 mm	2.20 mm	3.75 mm
Alvium 1800 C-500m/c	19.739 mm	1.67 mm	1.30 mm	2.40 mm	3.95 mm
Alvium 1800 C-507m/c	19.929 mm	2.27 mm	1.25 mm	2.20 mm	3.75 mm
Alvium 1800 C-507m/c Pol	19.929 mm	2.27 mm	1.25 mm	2.20 mm	3.75 mm
Alvium 1800 C-508m/c	19.929 mm	2.27 mm	1.25 mm	2.20 mm	3.75 mm
Alvium 1800 C-508m/c Pol	19.929 mm	2.27 mm	1.25 mm	2.20 mm	3.75 mm
Alvium 1800 C-510m/c	19.713 mm	2.20 mm	1.10 mm	2.20 mm	3.75 mm
Alvium 1800 C-511m/c	19.613 mm	2.88 mm	1.00 mm	2.20 mm	3.75 mm
Alvium 1800 C-530 VSWIR	19.713 mm	2.83 mm	1.10 mm	2.20 mm	3.75 mm
Alvium 1800 C-811m/c	19.613 mm	2.88 mm	1.00 mm	2.20 mm	3.75 mm
Alvium 1800 C-812 UV	19.610 mm	2.88 mm	1.00 mm	2.20 mm	3.75 mm
Alvium 1800 C-895m/c	19.829 mm	2.27 mm	1.15 mm	2.20 mm	3.75 mm
Alvium 1800 C-1236m/c	19.829 mm	2.27 mm	1.15 mm	2.20 mm	3.75 mm
Alvium 1800 C-1240m/c	19.763 mm	2.20 mm	1.15 mm	2.20 mm	3.75 mm
Alvium 1800 C-1242m/c	19.613 mm	2.88 mm	1.00 mm	2.20 mm	3.75 mm
Alvium 1800 C-1620m/c	19.613 mm	2.88 mm	1.00 mm	2.20 mm	3.75 mm
Alvium 1800 C-2040m/c	19.613 mm	2.88 mm	1.00 mm	2.20 mm	3.75 mm

\*Theoretical values

Table 96: Bare Board (standard Alvium and Alvium Flex) model specific dimensions and nominal values (sheet 1 of 2)

Camera model	ML: Mechanical length* for C-Mount	CH: Components height, incl. the sensor	B1: Board thickness	B2: Board thickness	B3: Board thickness
Alvium 1800 C-2050m/c	19.663 mm	2.87 mm	1.05 mm	2.20 mm	3.75 mm
Alvium 1800 C-2460m/c	19.613 mm	2.88 mm	1.00 mm	2.20 mm	3.75 mm

\*Theoretical values

Table 96: Bare Board (standard Alvium and Alvium Flex) model specific dimensions and nominal values (sheet 2 of 2)

## Open Housing C-Mount (standard Alvium)

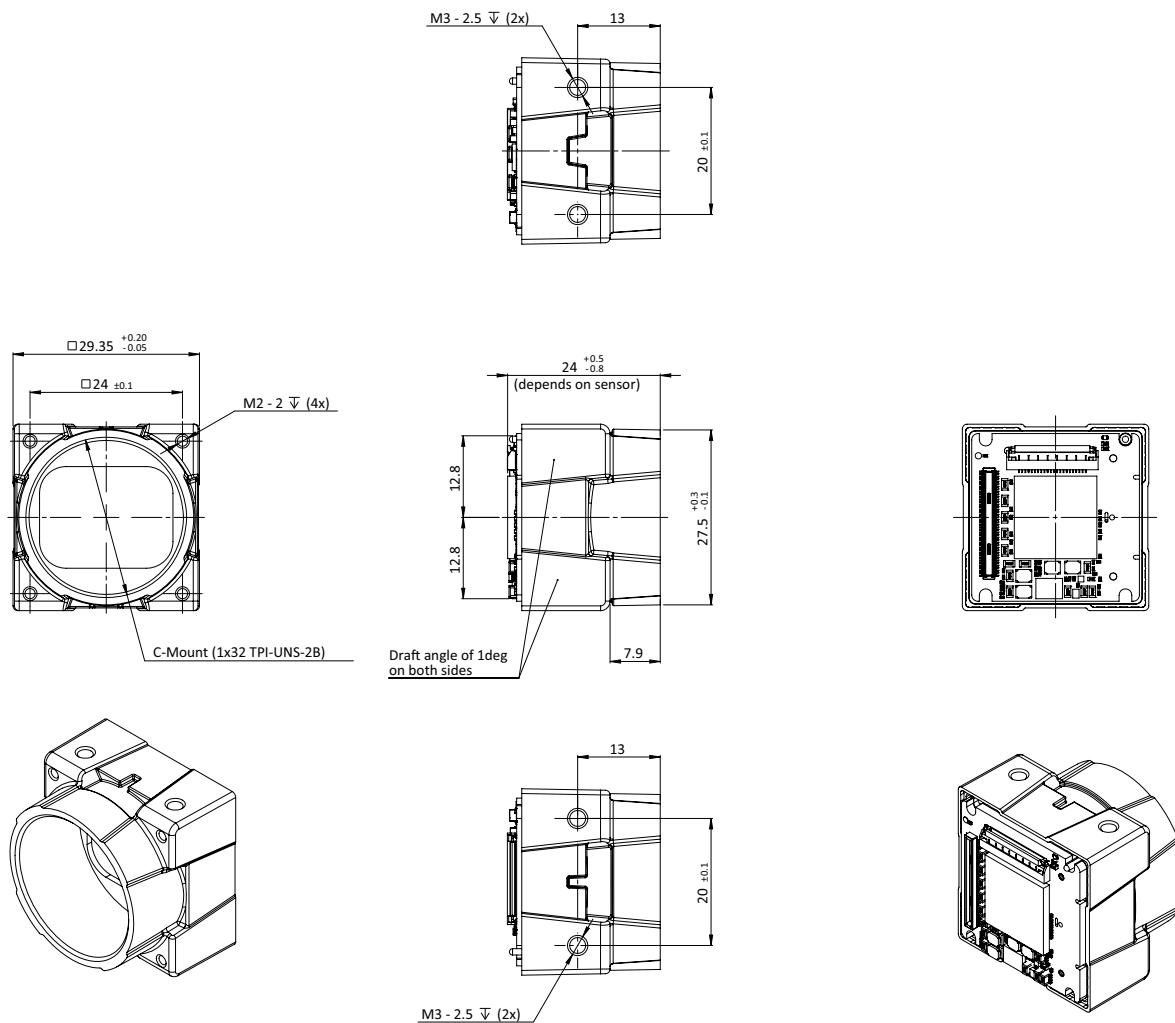

Figure 65: Open Housing C-Mount (standard Alvium) dimensions

## Open Housing CS-Mount (standard Alvium)

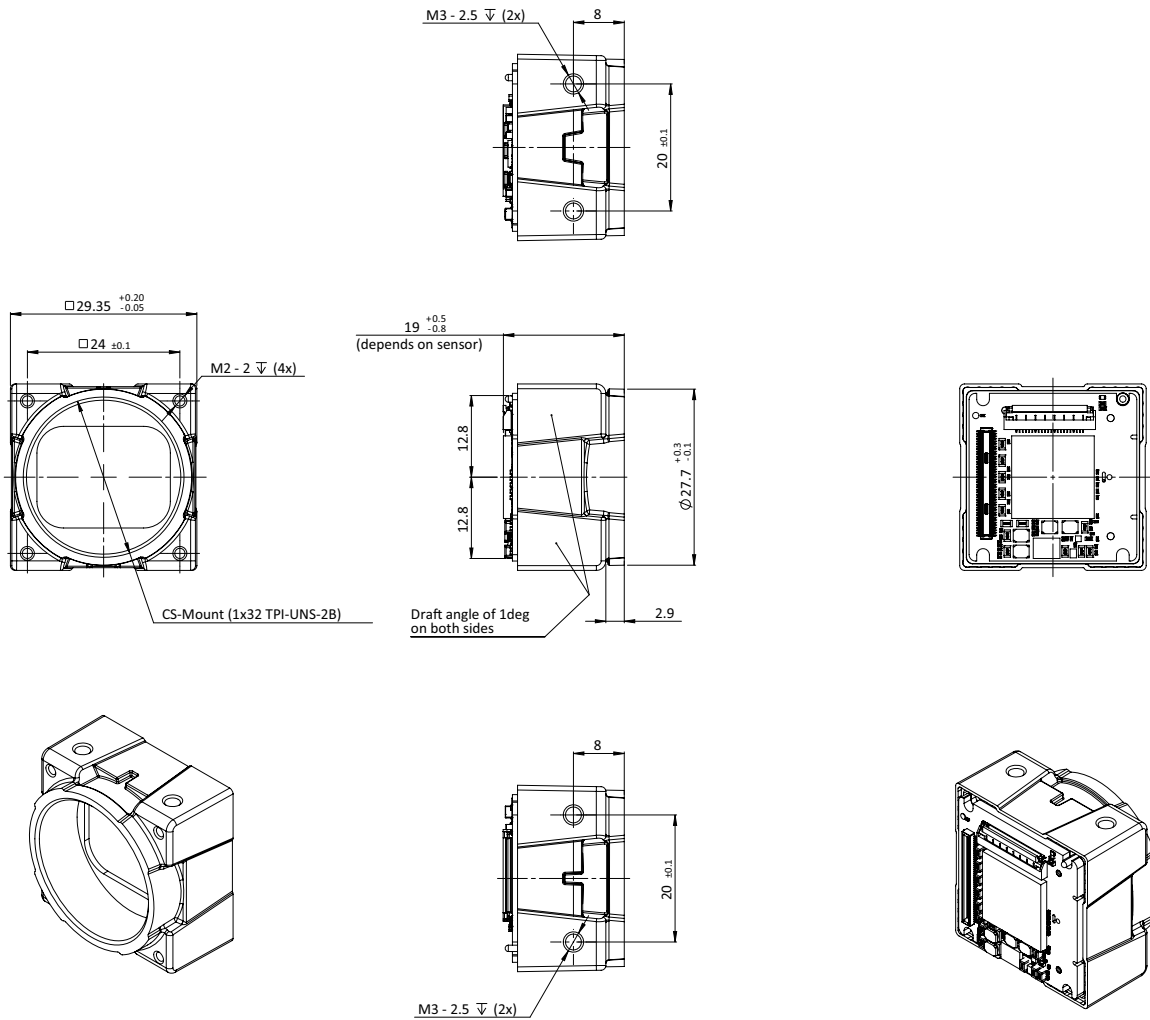

Figure 66: Open Housing CS-Mount (standard Alvium) dimensions

## Open Housing S-Mount (standard Alvium)

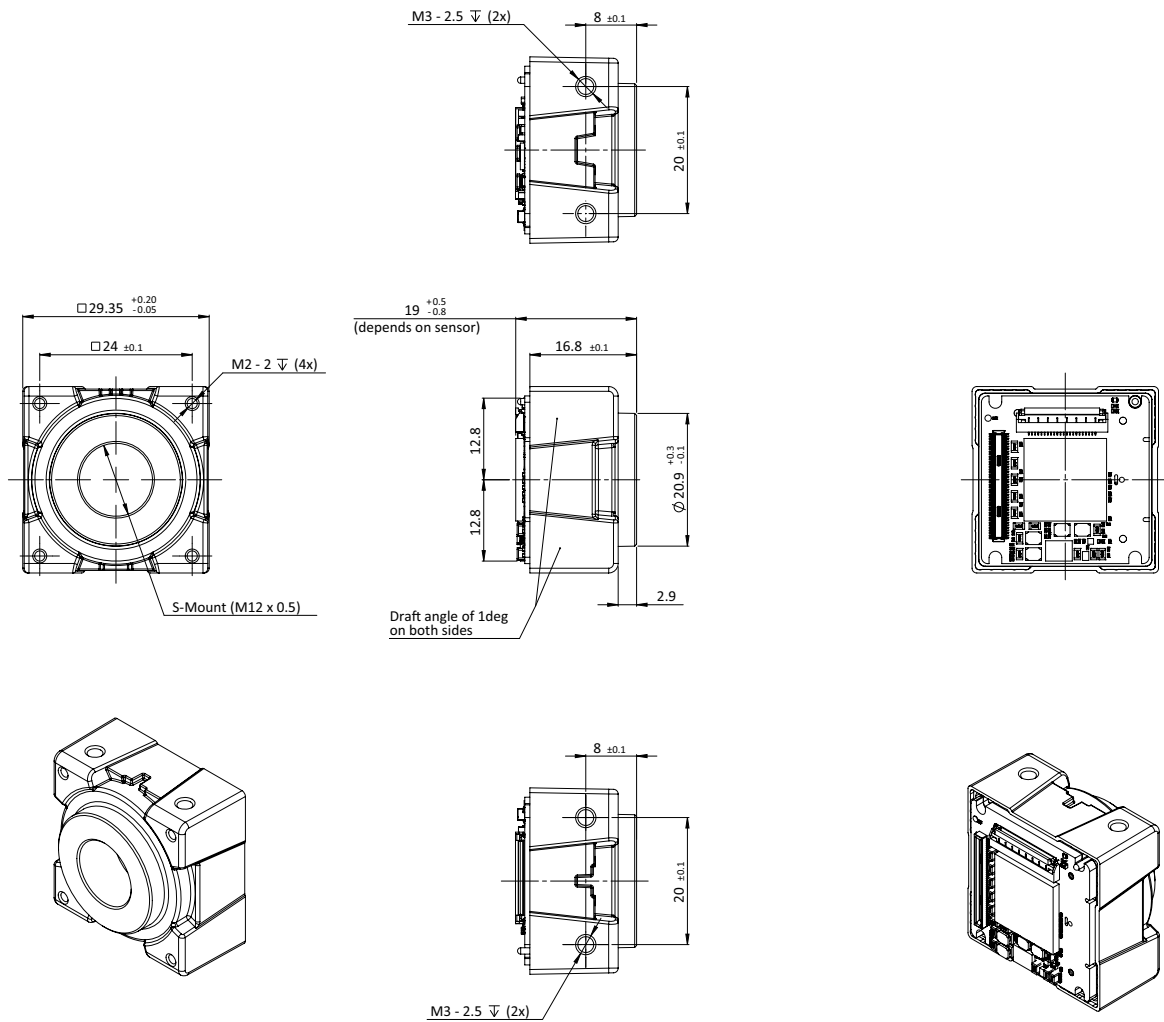

Figure 67: Open Housing S-Mount (standard Alvium) dimensions

## Alvium Flex: Dimensions and mass

Bare board cameras	Specification
Dimensions (L × W × H)	[Model specific] × 26 mm × 26 mm
Mass [g]	10 g

Table 97: Bare board dimensions and mass (Alvium Flex)

Open housing cameras	C-Mount	CS-Mount	S-Mount
Flange focal distance, optical	17.526 mm	12.526 mm	12.63 mm
Thread	1"-32tpi UNS-2B	1"-32tpi UNS-2B	M12 mm × 0.5 mm
Maximum protrusion <sup>1</sup>	13.6 mm	8.6 mm	11.0 mm
Body dimensions (L × W × H) in [mm]	25 × 29 × 29	20 × 29 × 29	20 × 29 × 29
Mass	40 g	40 g	40 g

<sup>1</sup>For details, see [Maximum protrusion for front mounts](#).

Table 98: Housing dimensions and mass (Alvium Flex)

## Alvium Flex: Technical drawings

Alvium CSI-2 Flex cameras are available with the following housing options:

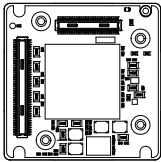
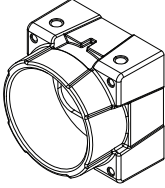
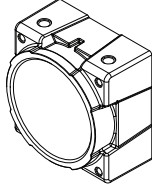
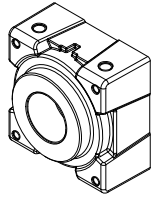
				
<b>Option</b>	Bare Board	Open Housing C-Mount	Open Housing CS-Mount	Open Housing S-Mount
<b>Page</b>	<a href="#">214</a>	<a href="#">215</a>	<a href="#">216</a>	<a href="#">217</a>

## Bare Board (Alvium Flex)

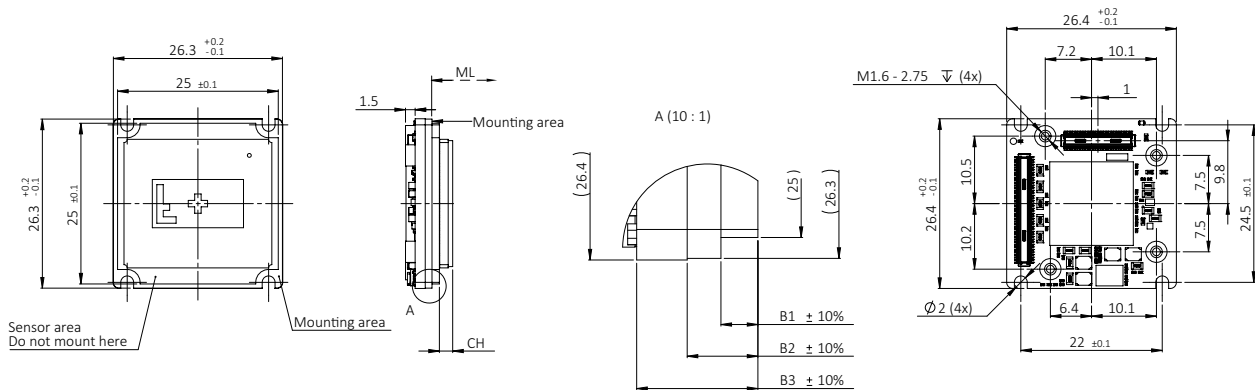

Figure 68: Bare Board (Alvium Flex) dimensions

Dimensions that are common between different models are shown in [Figure 68](#), model specific dimensions are listed in [Table 96](#). **Mechanical length** (ML) defines the mechanical distance from the mounting area to the lens mount front flange, without optical filter. **Components height** (CH) relates to the electronic components with maximum height, sometimes the sensor.

## Open Housing C-Mount (Alvium Flex)

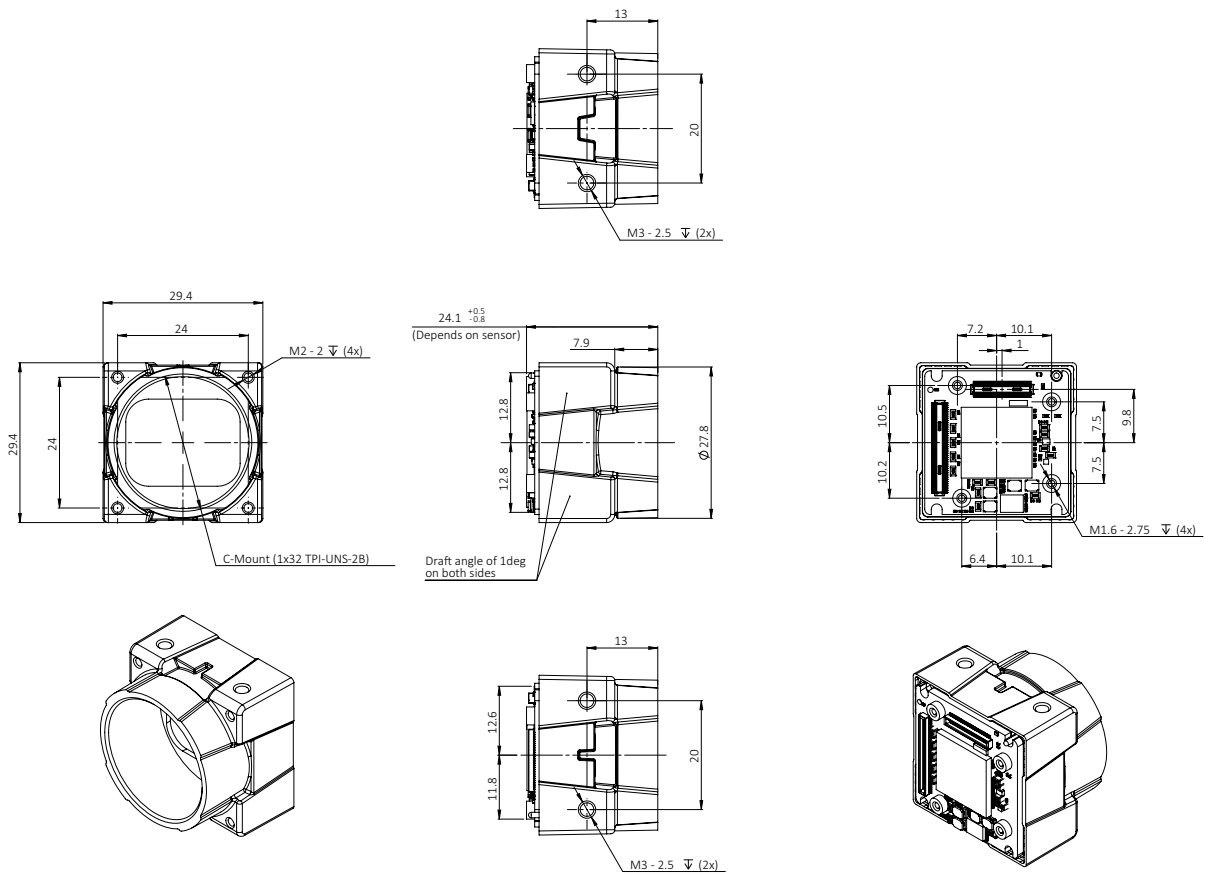

Figure 69: Open Housing C-Mount (Alvium Flex) dimensions

## Open Housing CS-Mount (Alvium Flex)

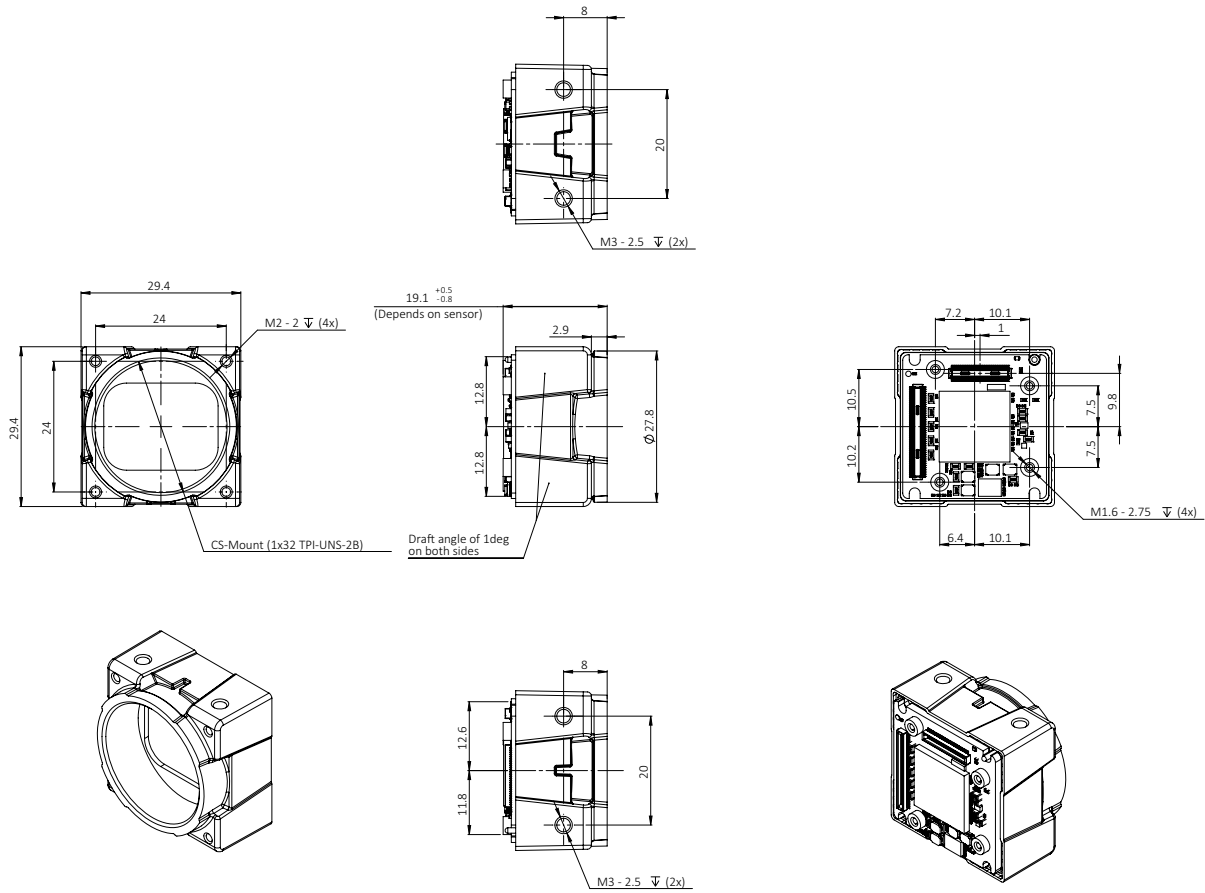

Figure 70: Open Housing CS-Mount (Alvium Flex) dimensions



## Open Housing S-Mount (Alvium Flex)

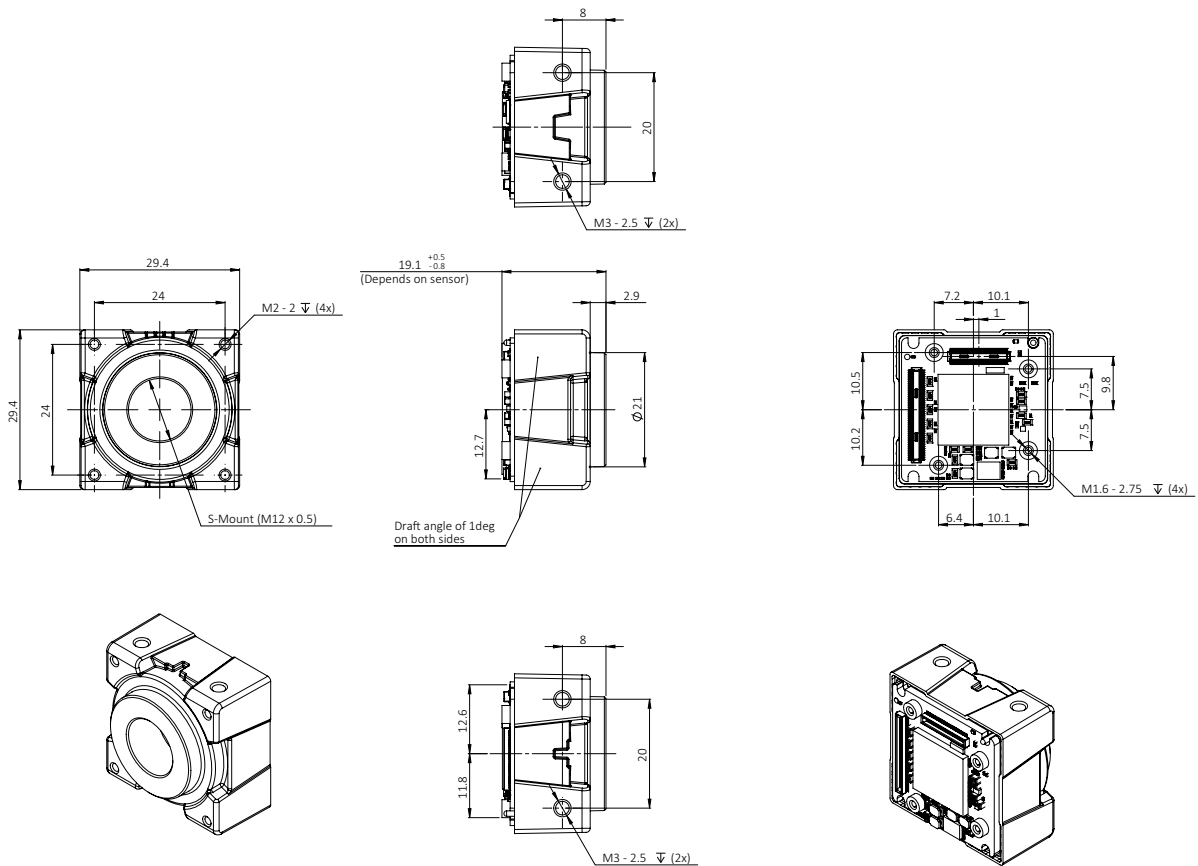

Figure 71: Open Housing S-Mount (Alvium Flex) dimensions

## Alvium Frame: Dimensions and mass

Frame cameras	Frame
Flange focal distance, optical	3.576 mm
Front hole diameter	24.5 mm
Maximum protrusion <sup>1</sup>	1.5 mm
Body dimensions (L × W × H)	10 mm × 29 mm × 29 mm
Mass	15 g

<sup>1</sup>For details, see [Maximum protrusion for front mounts](#).

Table 99: Housing dimensions and mass (Alvium Frame)

## Alvium Frame: Technical drawings

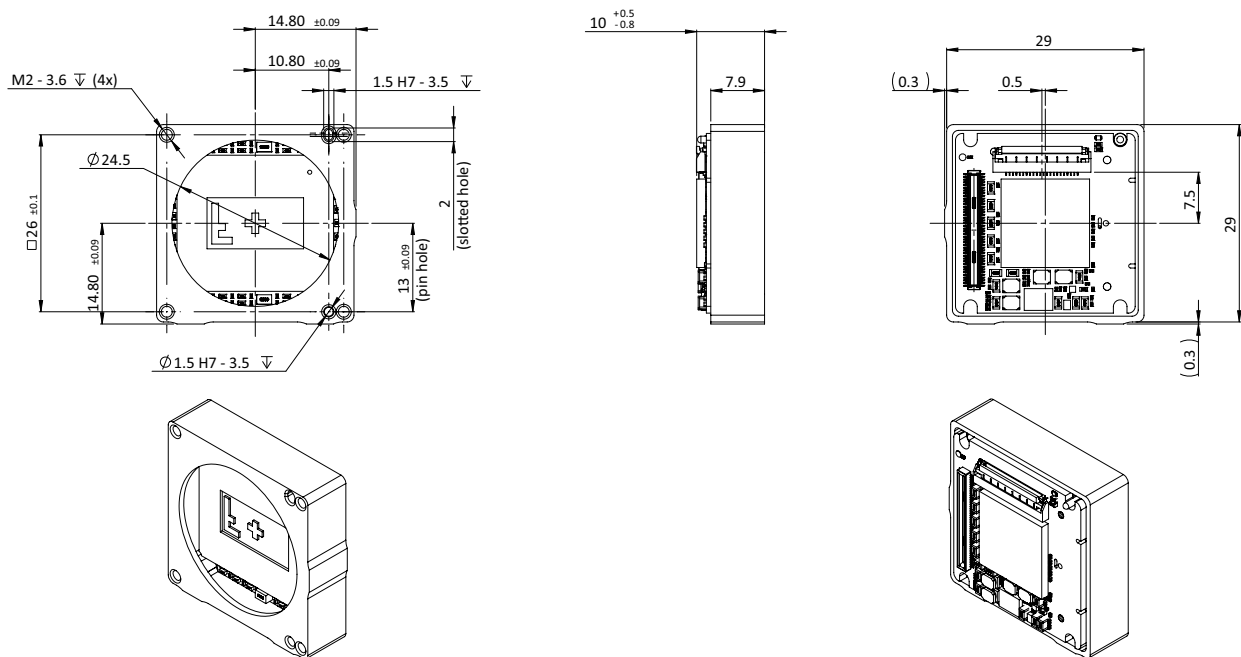

Figure 72: Alvium Frame dimensions

# Alvium Frame Flex: Dimensions and mass

Frame cameras	Frame
Flange focal distance, optical	3.576 mm
Front hole diameter	24.5 mm
Maximum protrusion <sup>1</sup>	1.5 mm
Body dimensions (L × W × H)	10.1 × 29 mm × 29 mm
Mass	15 g

<sup>1</sup>For details, see [Maximum protrusion for front mounts](#).

Table 100: Housing dimensions and mass (Alvium Frame Flex)

# Alvium Frame Flex: Technical drawings

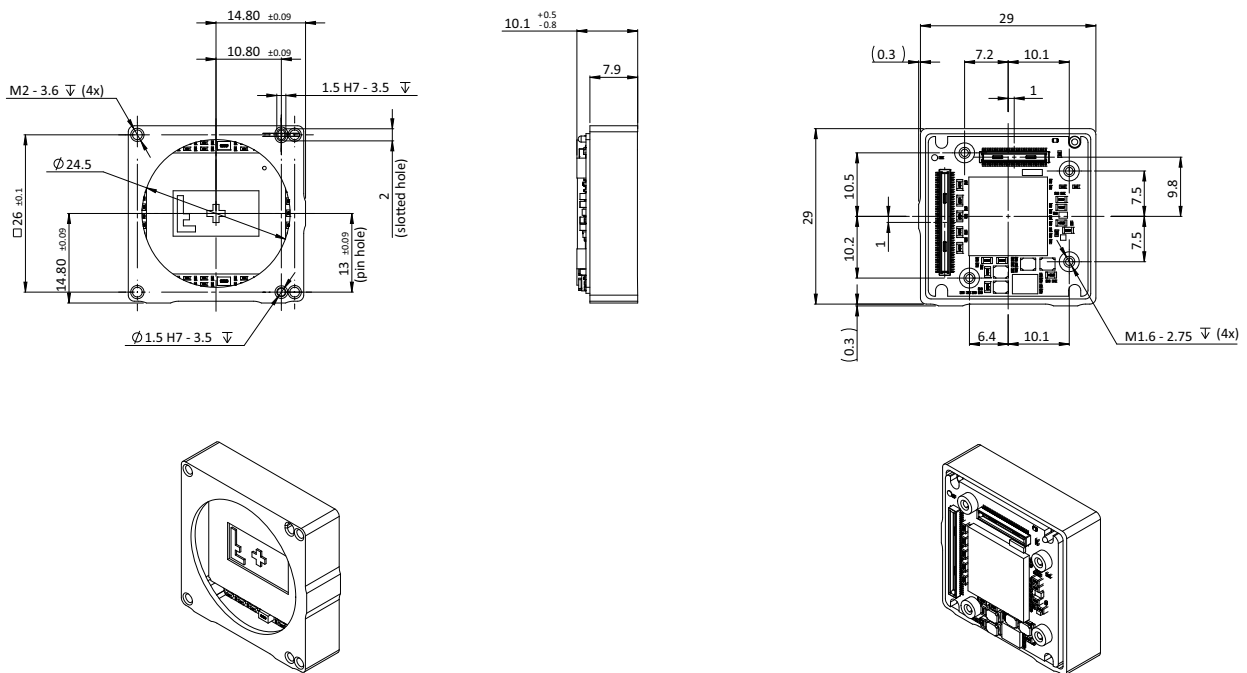

Figure 73: Alvium Frame Flex dimensions

# Maximum protrusion for front mounts



## No need to readjust lens mounts

Alvium CSI-2 camera mounts are adjusted with high precision during manufacturing. Construction ensures permanent accuracy without need to readjust.

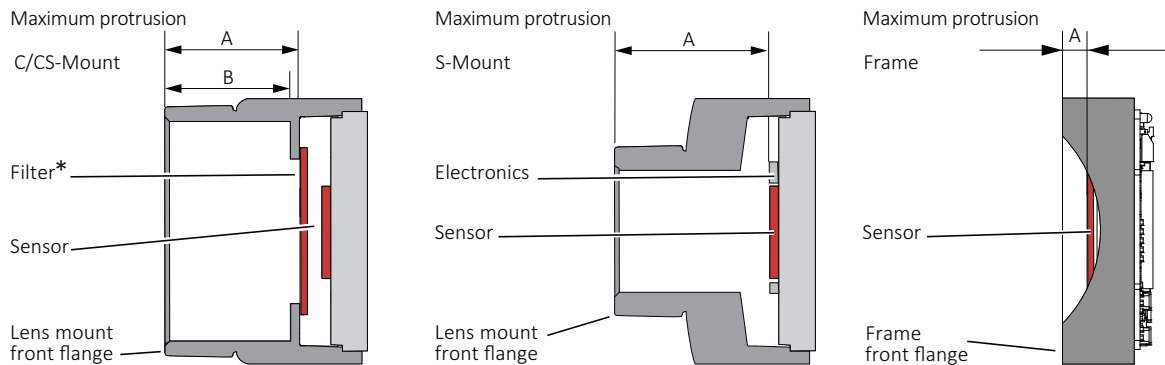

\*Only color models are equipped with an IR cut filter

Figure 74: Maximum protrusion CS-Mount and C-Mount, S-Mount, Frame

Figure 74 shows schematics for maximum protrusion of objects (typically lenses), Table 101 shows values for maximum protrusion.



### NOTICE

#### Damage to sensor, optics, or electronics by unsuitable lenses or objects

The sensor, filter, lens, or camera electronics can be damaged if an object (typically a lens) exceeding maximum protrusion is mounted to the camera

- Use lenses with less than the allowed maximum protrusion, see Table 101.
- Mount objects with less than the allowed maximum protrusion, see Table 101.
- See [Mounting the lens](#) on page 262.
- For S-Mount lenses, see [Mounting and focusing S-Mount lenses](#) on page 263.

Mount	Maximum protrusion
C-Mount	13.6 mm
CS-Mount	8.6 mm
S-Mount	11.0 mm
Frame	1.5 mm

Table 101: Alvium CSI-2 cameras maximum protrusion

## IR cut filter

Table 102 shows which Alvium models are equipped with an IR cut filter. The filter is permanently installed and cannot be removed.

Color or monochrome model	C-Mount	CS-Mount	S-Mount	Bare Board	Frame
Color	Type Hoya C-5000 IR cut filter			No filter	
Monochrome and VSWIR	No filter				

Table 102: Optical filter availability

Cameras **without** IR cut filter have a higher sensitivity for low-light imaging. Moreover, spectral sensitivity is increased.

Cameras **with** IR cut filter are more accurate in reproduction of color, contrast, and sharpness, as the filter absorbs near-IR wavelengths. See Figure 75 for filter transmission.



### Spectral transmission values

The following curve shows typical transmission for type Hoya C-5000 IR cut filter. Values may vary slightly by filter lot.

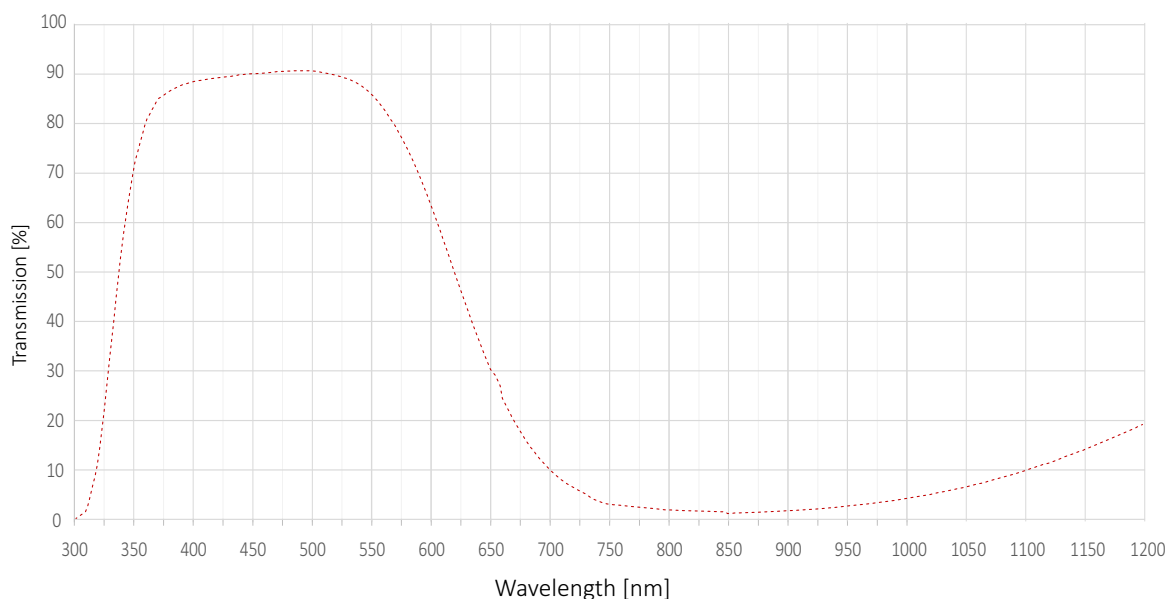

Figure 75: Type Hoya C-5000 IR cut filter spectral transmission (exemplary curve)



### S-Mount lenses with IR cut design

For improved image quality, we recommend using S-Mount lenses that are IR-optimized or that have IR cut coating. See the S-Mount Lenses User Guide at [www.alliedvision.com/fileadmin/content/documents/products/accessories/lenses/Allied\\_Vision/User\\_Guide/S-Mount-Lenses\\_User-Guide.pdf](http://www.alliedvision.com/fileadmin/content/documents/products/accessories/lenses/Allied_Vision/User_Guide/S-Mount-Lenses_User-Guide.pdf).

# Sensor position accuracy



## Sensor alignment for bare board cameras

The sensors in Alviium bare board cameras are not aligned to a lens mount. You must align these cameras into housings individually, which can be difficult and expensive. As a possible solution, Alviium Frame cameras provide alignment areas and holes to fit into individual housings, see [Alviium Frame- use your own optical mount](#) on page 21.

## Housed standard and Flex cameras: Sensor shift and rotation

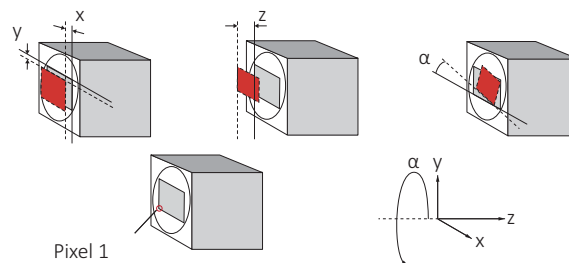

**Gray rectangle:** Reference sensor position    **Red rectangle:** Current position  
**Straight line:** Reference edge    **Dotted line:** Current reference edge

The orientation of the z-axis deviates from scientific conventions to define tolerances of the flange focal distance.

Figure 76: Sensor shift and rotation

The following table defines the manufacturing accuracy for sensor positioning with housed standard and Flex cameras.

Criteria	Subject	Properties
Alignment method		Optical alignment of the photosensitive sensor area into the camera front module (lens mount front flange)
Reference Points	Sensor	Center of the pixel area (photo sensitive cells)
	Camera	Center of the lens mount
Accuracy	x/y-axis <sup>1</sup>	±150 µm (sensor shift)
	z	0 to -100 µm (optical back focal length)
	α <sup>1</sup>	±0.5 deg (sensor rotation as the deviation from the parallel to the camera bottom)

<sup>1</sup> We cannot measure or guarantee these values for S-Mount hardware options that are manufactured on customer request for: Alviium 1800 C-052, -203, -234, -235, -291, -320 VSWIR, -507, -507 Pol, -508, -508 Pol, -511, -530 VSWIR, -811, -812 UV, -895, -1236, -1242, -1620, -2040, -2050, -2460.

Table 103: Alviium CSI-2 cameras, criteria of sensor position accuracy



### Values for Alvium Frame cameras

For sensor shift and rotation with Alvium Frame cameras, see [Housed Alvium Frame: Sensor shift and rotation](#) on page 223. For sensor tilt, see [All housed Alvium CSI-2 cameras: Sensor tilt](#) on page 223.

## Housed Alvium Frame: Sensor shift and rotation

The following table defines the manufacturing accuracy for sensor positioning with housed Alvium Frame cameras. For sensor tilt, see [All housed Alvium CSI-2 cameras: Sensor tilt](#) on page 223.

Criteria	Subject	Properties
Alignment method		Optical alignment of the photosensitive sensor area into the camera front module (lens mount front flange)
Reference Points	Sensor	Center of the pixel area (photo sensitive cells)
	Camera	Center of the Frame lens mount
Accuracy	x/y-axis	$\pm 90 \mu\text{m}$ (sensor shift)
	z	0 to $-50 \mu\text{m}$ (optical back focal length)
	$\alpha^1$	$\pm 0.5 \text{ deg}$ (sensor rotation as the deviation from the parallel to the camera bottom)

Table 104: Alvium CSI-2 Frame cameras, sensor shift and rotation

## All housed Alvium CSI-2 cameras: Sensor tilt

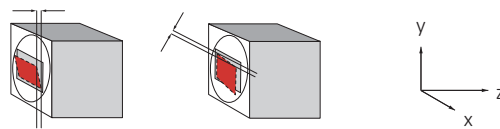

**Gray rectangle:** Reference sensor position    **Red rectangle:** Current position

Figure 77: Sensor tilt

The following table defines sensor tilt as the variance between highest and lowest pixel of a sensor along the z-axis, measured in micrometers for housed Alvium CSI-2 cameras.

Alvium model	Pixel size	Maximum tilt
Alvium 1500 C-050m/c	$4.8 \mu\text{m} \times 4.8 \mu\text{m}$	$47 \mu\text{m}$
Alvium 1500 C-120m/c	$3.75 \mu\text{m} \times 3.75 \mu\text{m}$	$29 \mu\text{m}$

Table 105: Sensor tilt (sheet 1 of 2)

<b>Alvium model</b>	<b>Pixel size</b>	<b>Maximum tilt</b>
Alvium 1500 C-210m/c	2.2 $\mu\text{m}$ $\times$ 2.2 $\mu\text{m}$	15 $\mu\text{m}$
Alvium 1500 C-500m/c	2.2 $\mu\text{m}$ $\times$ 2.2 $\mu\text{m}$	15 $\mu\text{m}$
Alvium 1500 C-501m/c NIR	2.2 $\mu\text{m}$ $\times$ 2.2 $\mu\text{m}$	15 $\mu\text{m}$
Alvium 1800 C-030 VSWIR	5 $\mu\text{m}$ $\times$ 5 $\mu\text{m}$	50 $\mu\text{m}$
Alvium 1800 C-040m/c	6.9 $\mu\text{m}$ $\times$ 6.9 $\mu\text{m}$	95 $\mu\text{m}$
Alvium 1800 C-052m/c	9 $\mu\text{m}$ $\times$ 9 $\mu\text{m}$	36 $\mu\text{m}$
Alvium 1800 C-130 VSWIR	5 $\mu\text{m}$ $\times$ 5 $\mu\text{m}$	50 $\mu\text{m}$
Alvium 1800 C-158m/c	3.45 $\mu\text{m}$ $\times$ 3.45 $\mu\text{m}$	24 $\mu\text{m}$
Alvium 1800 C-203m/c	4.5 $\mu\text{m}$ $\times$ 4.5 $\mu\text{m}$	41 $\mu\text{m}$
Alvium 1800 C-158m/c	3.45 $\mu\text{m}$ $\times$ 3.45 $\mu\text{m}$	24 $\mu\text{m}$
Alvium 1800 C-235m/c	5.86 $\mu\text{m}$ $\times$ 5.86 $\mu\text{m}$	69 $\mu\text{m}$
Alvium 1800 C-240m/c	3.45 $\mu\text{m}$ $\times$ 3.45 $\mu\text{m}$	24 $\mu\text{m}$
Alvium 1800 C-291m/c	4.5 $\mu\text{m}$ $\times$ 4.5 $\mu\text{m}$	18 $\mu\text{m}$
Alvium 1800 C-319m/c	3.45 $\mu\text{m}$ $\times$ 3.45 $\mu\text{m}$	24 $\mu\text{m}$
Alvium 1800 C-320 VSWIR	3.45 $\mu\text{m}$ $\times$ 3.45 $\mu\text{m}$	24 $\mu\text{m}$
Alvium 1800 C-500m/c	2.2 $\mu\text{m}$ $\times$ 2.2 $\mu\text{m}$	15 $\mu\text{m}$
Alvium 1800 C-507m/c	3.45 $\mu\text{m}$ $\times$ 3.45 $\mu\text{m}$	24 $\mu\text{m}$
Alvium 1800 C-507m/c Pol	3.45 $\mu\text{m}$ $\times$ 3.45 $\mu\text{m}$	24 $\mu\text{m}$
Alvium 1800 C-508m/c	3.45 $\mu\text{m}$ $\times$ 3.45 $\mu\text{m}$	24 $\mu\text{m}$
Alvium 1800 C-508m/c Pol	3.45 $\mu\text{m}$ $\times$ 3.45 $\mu\text{m}$	24 $\mu\text{m}$
Alvium 1800 C-510m/c	2.74 $\mu\text{m}$ $\times$ 2.74 $\mu\text{m}$	18 $\mu\text{m}$
Alvium 1800 C-511m/c	2.74 $\mu\text{m}$ $\times$ 2.74 $\mu\text{m}$	18 $\mu\text{m}$
Alvium 1800 C-530 VSWIR	3.45 $\mu\text{m}$ $\times$ 3.45 $\mu\text{m}$	24 $\mu\text{m}$
Alvium 1800 C-811m/c	2.74 $\mu\text{m}$ $\times$ 2.74 $\mu\text{m}$	18 $\mu\text{m}$
Alvium 1800 C-812 UV	2.74 $\mu\text{m}$ $\times$ 2.74 $\mu\text{m}$	15 $\mu\text{m}$
Alvium 1800 C-895m/c	3.45 $\mu\text{m}$ $\times$ 3.45 $\mu\text{m}$	24 $\mu\text{m}$
Alvium 1800 C-1236m/c	3.45 $\mu\text{m}$ $\times$ 3.45 $\mu\text{m}$	24 $\mu\text{m}$
Alvium 1800 C-1240m/c	2.74 $\mu\text{m}$ $\times$ 2.74 $\mu\text{m}$	18 $\mu\text{m}$
Alvium 1800 C-1242m/c	3.45 $\mu\text{m}$ $\times$ 3.45 $\mu\text{m}$	24 $\mu\text{m}$
Alvium 1800 C-1640m/c	2.74 $\mu\text{m}$ $\times$ 2.74 $\mu\text{m}$	18 $\mu\text{m}$
Alvium 1800 C-2040m/c	2.74 $\mu\text{m}$ $\times$ 2.74 $\mu\text{m}$	18 $\mu\text{m}$
Alvium 1800 C-2050m/c	2.4 $\mu\text{m}$ $\times$ 2.4 $\mu\text{m}$	12 $\mu\text{m}$
Alvium 1800 C-2460m/c	2.74 $\mu\text{m}$ $\times$ 2.74 $\mu\text{m}$	18 $\mu\text{m}$

Table 105: Sensor tilt (sheet 2 of 2)





## User sets

### Supported features

UserSet features enable to store individual settings on selected Alvium 1800 C cameras. These user sets can be loaded by default, without needing to set values by software after every restart of the camera. Or they can be used to switch between different settings, for example, to adjust from daylight to artificial light.

User sets support all features except for:

- Selectors
- Command features
- Read-only features
- Features that do not apply to the corresponding interface, such as USB related features on a CSI-2 camera
- Features in the LUTControl1 category.

### Trigger features and UserSetDefault

Trigger features are reset to default values when the default user set is loaded.

Column `UserSetLoad` displays how user values are affected when the command for `UserSetLoad` is executed.

Feature	Default value	UserSetDefault
TriggerActivation	<i>RisingEdge</i>	Default value
TriggerMode	<i>Off</i>	Default value
TriggerSelector	<i>AcquisitionStart</i>	User value
TriggerSoftware	[Command]	Not applicable
TriggerSource	<i>Software</i>	Default value

Table 106: Trigger features being reset

## Camera feature availability

Alvium CSI-2 cameras support a number of standard and extended controls and features. The following tables compare the availability of selected controls and features by model.



### Feature descriptions and firmware downloads

**GenICam for CSI-2 Access:** Alvium Features Reference:

[www.alliedvision.com/en/support/technical-documentation/alvium-csi-2-documentation](http://www.alliedvision.com/en/support/technical-documentation/alvium-csi-2-documentation)

Other access modes: Alvium CSI-2 Register Controls Reference:

[www.alliedvision.com/en/support/technical-documentation/alvium-csi-2-documentation](http://www.alliedvision.com/en/support/technical-documentation/alvium-csi-2-documentation)

Firmware downloads: [www.alliedvision.com/en/support/firmware-downloads](http://www.alliedvision.com/en/support/firmware-downloads)

Image control	Monochrome models	Color models	Supported models
Adaptive noise correction	✓	✓	All 1800 C models, <b>except</b> for: 1800 C-507 Pol, -508 Pol
Auto exposure	✓	✓	All
Auto gain	✓	✓	All
Auto white balance	-	✓	All, <b>except</b> for:
Color transformation (including hue, saturation)	-	✓	1800 C-507 Pol, -508 Pol
Contrast	✓	✓	All 1800 C models, <b>except</b> for:
Custom convolution	✓	✓	1800 C-507 Pol, -508 Pol
De-Bayering up to 5×5	-	✓	All, <b>except</b> for:
<b>Digital</b> binning	✓	✓	1800 C-507 Pol, -508 Pol
DPC (defect pixel correction)	✓	✓	-508 Pol
FPNC (fixed pattern noise correction)	✓	✓	All, <b>except</b> for: 1800 C-030 VSWIR, -052, -130 VSWIR, -203, -234, -235, -291, -320 VSWIR, -507 Pol, -508 Pol, -530 VSWIR, -895, -2050

Table 107: Image control features by Alvium CSI-2 camera model (sheet 1 of 2)

Image control	Monochrome models	Color models	Supported models
Gamma	✓	✓	All
Lens shading correction	✓	✓	All 1800 C models
Look up table (LUT)	✓	✓	All 1800 C models, <b>except</b> for: 1800 C-507 Pol, -508 Pol
Reverse X/Y	✓	✓	All
<b>Sensor</b> binning	✓	-	1800 C-158m, -203m, -240m, -291m, -500m, -508m, -510m, -511m, -811m, -812 UV, -1242m, -1620m, -2040m, -2460m
Sharpness/Blur	✓	✓	All 1800 C models, <b>except</b> for: 1800 C-507 Pol, -508 Pol
Single ROI (region of interest)	✓	✓	All

Table 107: Image control features by Alvium CSI-2 camera model (sheet 2 of 2)

Camera control	Monochrome models	Color models	Supported models
Acquisition frame rate	✓	✓	All
Counters and timers	✓	✓	All 1800 C models
Firmware update in the field	✓	✓	All
Image chunk data	✓	✓	All 1800 C models
I/O and trigger control	✓	✓	All
Sensor ADC readout modes ( <b>SensorBitDepth</b> )	✓	✓	1800 C-030 VSWIR, -040, -052, -130 VSWIR, -158, -203, -234, -235, -240, -291, -320 VSWIR, -508, -508 Pol, 530 VSWIR
Serial I/Os	✓	✓	All 1800 C models

Table 108: Camera control features by Alvium CSI-2 camera model (sheet 1 of 2)

Camera control	Monochrome models	Color models	Supported models
Temperature monitoring (mainboard)	✓	✓	All
User sets	✓	✓	All 1800 C models

*Table 108: Camera control features by Alvium CSI-2 camera model (sheet 2 of 2)*

# Lenses: Focal length vs. field of view



This chapter includes:

About this chapter .....	230
Optical vignetting with certain lenses .....	230
About S-Mount lenses .....	231
Focal length vs. field of view .....	231

## About this chapter

This section presents tables that list selected fields of view (FOV) depending on sensor size, distance, and focal length of the lens.

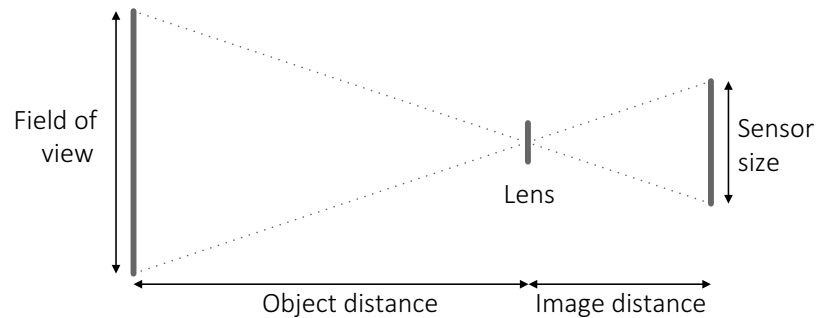

Figure 78: Parameters used in tables for focal length versus FOV



### Allied Vision S-Mount lenses

For technical data of Allied Vision S-Mount lenses with dedicated operating instructions, see the S-Mount Lenses User Guide at [www.alliedvision.com/fileadmin/content/documents/products/accessories/lenses/Allied\\_Vision/User\\_Guide/S-Mount-Lenses\\_User-Guide.pdf](http://www.alliedvision.com/fileadmin/content/documents/products/accessories/lenses/Allied_Vision/User_Guide/S-Mount-Lenses_User-Guide.pdf).

## Parameters in tables

The distance to the object is measured from the first principal the plane of the lens to the object. For some lenses, manufacturers do not define the principal plane position. Production spread causes tolerances for all values, including actual focal lengths. Calculations apply for image reproduction without distortion. Therefore, values do not apply for fisheye lenses.

Please ask your Allied Vision Sales representative in case you need more information.

## Optical vignetting with certain lenses

Lenses with short focal lengths may show optical vignetting at the edges of the image. Microlenses on the sensor pixels can increase the effect.

For demanding applications, we suggest testing camera and lens to find a suitable setup. If you have questions, please contact your Allied Vision Sales representative.

## About S-Mount lenses

Alvium CSI-2 models with S-Mount have no filter. For typical applications, we recommend using S-Mount lenses with an integrated IR cut filter for a better image quality.

Read [Mounting and focusing S-Mount lenses](#) on page 263 to avoid damage when using S-Mount lenses.

## Focal length vs. field of view

### Alvium 1500 C-050m/c

Values for 1500 C-050m/c cameras (aspect ratio 1:1.34) with Type 1/3.6 (4.9 mm diagonal) sensors:

Focal length [mm]	Field of view (H × V [mm])	
	Object distance = 500 mm	Object distance = 1000 mm
2.8	689 × 517	1381 × 1036
3.6	535 × 401	1073 × 805
4.8	400 × 300	804 × 603
6	319 × 239	643 × 482
8	239 × 179	481 × 361
12	158 × 118	319 × 239
16	117 × 88	239 × 179
25	74 × 55	151 × 113

Table 109: Focal length versus field of view for Alvium 1500 C-050m/c

## Alvium 1500 C-120m/c

Values for 1500 C-120m/c cameras with Type 1/3 (6.0 mm diagonal) sensors:

Focal length [mm]	Field of view (H × V [mm])	
	Object distance = 500 mm	Object distance = 1000 mm
2.8	852 × 639	1709 × 1282
3.6	662 × 496	1329 × 996
4.8	495 × 371	995 × 746
6	395 × 296	795 × 596
8	295 × 221	595 × 446
12	195 × 146	395 × 296
16	145 × 109	295 × 221
25	91 × 68	187 × 140

Table 110: Focal length versus field of view for Alvium 1500 C-120m/c

## Alvium 1500 C-210m/c

Values for 1500 C-210m/c cameras (aspect ratio 1:1.75) with Type 1/3.6 (4.9 mm diagonal) sensors:.

Focal length [mm]	Field of view (H × V in [mm])	
	Object distance = 500 mm	Object distance = 1000 mm
2.8	746 × 426	1496 × 855
3.6	579 × 331	1162 × 664
4.8	433 × 248	871 × 498
6	346 × 198	696 × 398
8	258 × 148	521 × 298
12	171 × 98	346 × 198
16	127 × 73	258 × 148
25	80 × 46	164 × 94

Table 111: Focal length versus field of view for Alvium 1500 C-210m/c



## Alvium 1500 C-500m/c, -501m/c NIR

Values for 1500 C-500m/c and -501m/c NIR cameras with Type 1/2.5 (7.1 mm diagonal) sensors:

Focal length [mm]	Field of view (H × V in [mm])	
	Object distance = 500 mm	Object distance = 1000 mm
2.8	1013 × 759	2031 × 1523
3.6	786 × 590	1578 × 1184
4.8	588 × 441	1182 × 887
6	469 × 352	945 × 709
8	351 × 263	707 × 530
12	232 × 174	469 × 352
16	172 × 129	351 × 263
25	108 × 81	222 × 167

Table 112: Focal length versus field of view for Alvium 1500 C-500m/c, -501m/c NIR

## Alvium 1800 C-030 VSWIR

Values for 1800 C-030 VSWIR cameras with Type 1/4 (4.1 mm diagonal) sensors:

Focal length [mm]	Field of view (H × V [mm])	
	Object distance = 500 mm	Object distance = 1000 mm
4	407 × 322	817 × 647
5	775 × 773	1557 × 1553
6	644 × 642	1296 × 1293
8	481 × 480	970 × 968
12	318 × 317	644 × 642
16	237 × 236	481 × 480
25	149 × 148	305 × 304
35	104 × 104	216 × 215
50	70 × 70	149 × 148

Table 113: Focal length versus field of view for Alvium 1800 C-030 VSWIR

## Alvium 1800 C-040m/c

Values for 1800 C-040m/c cameras with Type 1/2.9 (6.3 mm diagonal) sensors:

Focal length [mm]	Field of view (H × V [mm])	
	Object distance = 500 mm	Object distance = 1000 mm
2.8	892 × 667	1789 × 1337
3.6	693 × 518	1390 × 1039
4.8	518 × 387	1041 × 778
6	414 × 309	832 × 622
8	309 × 231	623 × 465
12	204 × 153	414 × 309
16	152 × 114	309 × 231
25	95 × 71	196 × 146

Table 114: Focal length versus field of view for Alvium 1800 C-040m/c

## Alvium 1800 C-052m/c

Values for 1800 C-052m/c cameras with Type 1/1.7 (9.2 mm diagonal) sensors:

Focal length [mm]	Field of view (H × V [mm])	
	Object distance = 500 mm	Object distance = 1000 mm
5	671 × 560	1348 × 1125
6	558 × 466	1122 × 937
8	417 × 348	840 × 701
12	275 × 230	558 × 466
16	205 × 171	417 × 348
25	129 × 107	264 × 221
35	90 × 75	187 × 156
50	61 × 51	129 × 107

Table 115: Focal length versus field of view for Alvium 1800 C-052m/c

## Alvium 1800 C-130 VSWIR

Values for 1800 C-130 VSWIR cameras with Type 1/2 (8.2 mm diagonal) sensors:

Focal length [mm]	Field of view (H × V [mm])	
	Object distance = 500 mm	Object distance = 1000 mm
5	671 × 560	1348 × 1125
6	558 × 466	1122 × 937
8	417 × 348	840 × 701
12	275 × 230	558 × 466
16	205 × 171	417 × 348
25	129 × 107	264 × 221
35	90 × 75	187 × 156
50	61 × 51	129 × 107

Table 116: Focal length versus field of view for Alvium 1800 C-130 VSWIR

## Alvium 1800 C-158m/c

Values for 1800 C-158m/c cameras with Type 1/2.9 (6.3 mm diagonal) sensors:

Focal length [mm]	Field of view (H × V [mm])	
	Object distance = 500 mm	Object distance = 1000 mm
2.8	892 × 667	1789 × 1337
3.6	693 × 518	1390 × 1039
4.8	518 × 387	1041 × 778
6	414 × 309	832 × 622
8	309 × 231	623 × 465
12	204 × 153	414 × 309
16	152 × 114	309 × 231
25	95 × 71	196 × 146

Table 117: Focal length versus field of view for Alvium 1800 C-158m/c

## Alvium 1800 C-203m/c

Values for 1800 C-203m/c cameras with Type 1/1.7 (9.2 mm diagonal) sensors:

Focal length [mm]	Field of view (H × V [mm])	
	Object distance = 500 mm	Object distance = 1000 mm
5	727 × 556	1461 × 1118
6	605 × 462	1217 × 930
8	452 × 345	911 × 696
12	299 × 228	605 × 462
16	222 × 170	452 × 345
25	140 × 107	286 × 219
35	98 × 75	202 × 155
50	66 × 51	140 × 107

Table 118: Focal length versus field of view for Alvium 1800 C-203m/c

## Alvium 1800 C-234m/c, -235m/c

Values for 1800 C-234m/c and -235m/c cameras with Type 1/1.2 (13.4 mm diagonal) sensors:

Focal length [mm]	Field of view (H × V in [mm])	
	Object distance = 500 mm	Object distance = 1000 mm
8	698 × 438 mm	1407 × 884 mm
12	461 × 290 mm	933 × 586 mm
16	343 × 215 mm	697 × 438 mm
25	215 × 135 mm	442 × 278 mm
35	150 × 94 mm	312 × 196 mm
50	102 × 64 mm	215 × 135 mm

Table 119: Focal length versus field of view for Alvium 1800 C-234m/c, -235m/c

## Alvium 1800 C-240m/c

Values for 1800 C-240m/c cameras with Type 1/2.3 (7.9 mm diagonal) sensors:

Focal length [mm]	Field of view (H × V in [mm])	
	Object distance = 500 mm	Object distance = 1000 mm
4.8	691 × 433	1389 × 871
6	552 × 346	1110 × 696
8	412 × 258	831 × 521
12	272 × 171	552 × 346
16	203 × 127	412 × 258
25	127 × 80	261 × 164
35	89 × 56	185 × 116
50	60 × 38	127 × 80

Table 120: Focal length versus field of view for Alvium 1800 C-240m/c

## Alvium 1800 C-291m/c

Values for 1800 C-291m/c cameras with Type 2/3 (10.8 mm diagonal) sensors:

Focal length [mm]	Field of view (H × V in [mm])	
	Object distance = 500 mm	Object distance = 1000 mm
6	644 × 642	1296 × 1293
8	481 × 480	970 × 968
12	318 × 317	644 × 642
16	237 × 236	481 × 480
25	149 × 148	305 × 304
35	104 × 104	216 × 215
50	70 × 70	149 × 148

Table 121: Focal length versus field of view for Alvium 1800 C-291m/c

## Alvium 1800 C-319m/c, -320 VSWIR

Values for 1800 C-319m/c cameras with Type 1/1.8 (8.9 mm diagonal) sensors:

Focal length [mm]	Field of view (H × V in [mm])	
	Object distance = 500 mm	Object distance = 1000 mm
4.8	735 × 550	1476 × 1104
6	586 × 439	1180 × 882
8	438 × 328	883 × 661
12	290 × 217	586 × 439
16	215 × 161	438 × 328
25	135 × 101	278 × 208
35	95 × 71	196 × 147
50	64 × 48	135 × 101

Table 122: Focal length versus field of view for Alvium 1800 C-319m/c, -320 VSWIR

## Alvium 1800 C-320 VSWIR

Values for 1800 C-320VSWIR cameras with Type 1/1.8 (8.9 mm diagonal) sensors:

Focal length [mm]	Field of view (H × V in [mm])	
	Object distance = 500 mm	Object distance = 1000 mm
6	591 × 439	1189 × 882
8	441 × 328	890 × 661
12	292 × 217	591 × 439
16	217 × 161	441 × 328
25	136 × 101	280 × 208
35	95 × 71	198 × 147
50	65 × 48	136 × 101
75	41 × 30	89 × 66

Table 123: Focal length versus field of view for Alvium 1800 C-320 VSWIR

## Alvium 1800 C-500m/c

Values for 1800 C-500m/c cameras with Type 1/2.5 (7.1 mm diagonal) sensors:

Focal length [mm]	Field of view (H × V in [mm])	
	Object distance = 500 mm	Object distance = 1000 mm
2.8	1013 × 759	2031 × 1523
3.6	786 × 590	1578 × 1184
4.8	588 × 441	1182 × 887
6	469 × 352	945 × 709
8	351 × 263	707 × 530
12	232 × 174	469 × 352
16	172 × 129	351 × 263
25	108 × 81	222 × 167

Table 124: Focal length versus field of view for Alvium 1800 C-500m/c

## Alvium 1800 C-507m/c, -507m/c Pol, -508m/c, -508m/c Pol

Values for 1800 C-507m/c, -507m/c Pol, -508m/c, and -508m/c Pol cameras with Type 2/3 (11.1 mm diagonal) sensors:

Focal length [mm]	Field of view (H × V in [mm])	
	Object distance = 500 mm	Object distance = 1000 mm
6	700 × 584	1408 × 1175
8	523 × 436	1054 × 880
12	346 × 288	700 × 584
16	257 × 215	523 × 436
25	162 × 135	332 × 277
35	113 × 94	234 × 196
50	77 × 64	162 × 135

Table 125: Focal length versus field of view for Alvium 1800 C-507m/c, -507m/c Pol, -508m/c, -508m/c Pol

## Alvium 1800 C-510m/c, -511m/c

Values for 1800 C-510m/c and -511m/c cameras with Type 1/1.8 (8.8 mm diagonal) sensors:

Focal length [mm]	Field of view (H × V in [mm])	
	Object distance = 500 mm	Object distance = 1000 mm
5	671 × 560	1348 × 1125
6	558 × 466	1122 × 937
8	417 × 348	840 × 701
12	275 × 230	558 × 466
16	205 × 171	417 × 348
25	129 × 107	264 × 221
35	90 × 75	187 × 156
50	61 × 51	129 × 107

Table 126: Focal length versus field of view for Alvium 1800 C-510m/c, -511m/c

## Alvium 1800 C-530 VSWIR

Values for 1800 C-530 VSWIR cameras with Type 1/1.4 (11.4 mm diagonal) sensors:

Focal length [mm]	Field of view (H × V in [mm])	
	Object distance = 500 mm	Object distance = 1000 mm
6	736 × 584	1481 × 1175
8	550 × 436	1109 × 880
12	364 × 288	736 × 584
16	271 × 215	550 × 436
25	170 × 135	349 × 277
35	119 × 94	247 × 196
50	80 × 64	170 × 135
75	51 × 40	110 × 87

Table 127: Focal length versus field of view for Alvium 1800 C-530 VSWIR



## Alvium 1800 C-811m/c, -812 UV

Values for 1800 C-811m/c and -812 UV cameras with Type 2/3 (11.0 mm diagonal) sensors:

Focal length [mm]	Field of view (H × V in [mm])	
	Object distance = 500 mm	Object distance = 1000 mm
5	773 × 773	1553 × 1553
6	642 × 642	1293 × 1293
8	480 × 480	968 × 968
12	317 × 317	642 × 642
16	236 × 236	480 × 480
25	148 × 148	304 × 304
35	104 × 104	215 × 215
50	70 × 70	148 × 148

Table 128: Focal length versus field of view for Alvium 1800 C-811m/c, -812 UV

## Alvium 1800 C-895m/c

Values for 1800 C-895m/c cameras with Type 1 (16.0 mm diagonal) sensors:

Focal length [mm]	Field of view (H × V in [mm])	
	Object distance = 500 mm	Object distance = 1000 mm
12	577 × 305	1168 × 618
16	429 × 227	873 × 462
25	270 × 143	553 × 293
35	189 × 100	391 × 286
50	128 × 68	270 × 143
100	57 × 30	128 × 68
135	38 × 20	91 × 48

Table 129: Focal length versus field of view for Alvium 1800 C-895m/c

## Alvium 1800 C-1236m/c

Values for 1800 C-1236m/c cameras with Type 1.1 (17.6 mm diagonal) sensors:

Focal length [mm]	Field of view (H × V in [mm])	
	Object distance = 500 mm	Object distance = 1000 mm
8	872 × 638	1759 × 1287
12	577 × 422	1168 × 854
16	429 × 314	872 × 638
25	270 × 197	553 × 405
35	188 × 138	391 × 286
50	128 × 93	270 × 197
75	80 × 59	175 × 128

Table 130: Focal length versus field of view for Alvium 1800 C-1236m/c

## Alvium 1800 C-1240m/c

Values for 1800 C-1240m/c cameras with Type 1/1.7 (9.3 mm diagonal) sensors:

Focal length [mm]	Field of view (H × V in [mm])	
	Object distance = 500 mm	Object distance = 1000 mm
4.8	763 × 578	1534 × 1161
6	609 × 461	1226 × 928
8	455 × 344	918 × 694
12	301 × 228	609 × 461
16	224 × 169	455 × 344
25	141 × 106	289 × 218
35	98 × 74	204 × 154
50	67 × 50	141 × 106

Table 131: Focal length versus field of view for Alvium 1800 C-1240m/c

## Alvium 1800 C-1242m/c

Values for 1800 C-1242m/c cameras with Type 1/1.1 (14.0 mm diagonal) sensors:

Focal length [mm]	Field of view (H × V in [mm])	
	Object distance = 500 mm	Object distance = 1000 mm
6	931 × 679	1874 × 1365
8	696 × 507	1403 × 1022
12	460 × 335	931 × 679
16	342 × 249	696 × 507
25	215 × 157	441 × 321
35	150 × 109	312 × 227
50	102 × 74	215 × 157
75	64 × 47	139 × 102

Table 132: Focal length versus field of view for Alvium 1800 C-1242m/c

## Alvium 1800 C-1620m/c

Values for 1800 C-1620m/c cameras with Type 1.1 (16.8mm diagonal) sensors:

Focal length [mm]	Field of view (H × V in [mm])	
	Object distance = 500 mm	Object distance = 1000 mm
5	1445 × 825	2905 × 1658
6	1202 × 686	2419 × 1380
8	898 × 512	1810 × 1033
12	594 × 339	1202 × 686
16	442 × 252	898 × 512
25	277 × 158	569 × 325
35	194 × 111	403 × 230
50	131 × 75	277 × 158
75	83 × 47	180 × 103

Table 133: Focal length versus field of view for Alvium 1800 C-1620m/c

## Alvium 1800 C-2040m/c

Values for 1800 C-2040m/c cameras with Type 1.1 (17.5 mm diagonal) sensors:

Focal length [mm]	Field of view (H × V in [mm])	
	Object distance = 500 mm	Object distance = 1000 mm
6	1018 × 1018	2048 × 2048
8	760 × 760	1533 × 1533
12	503 × 503	1018 × 1018
16	374 × 374	760 × 760
25	235 × 235	482 × 482
35	164 × 164	341 × 341
50	111 × 111	235 × 235
75	70 × 70	152 × 152
85	60 × 60	133 × 133

Table 134: Focal length versus field of view for Alvium 1800 C-2040m/c

## Alvium 1800 C-2050m/c

Values for 1800 C-2050m/c cameras with Type 1 (15.8 mm diagonal) sensors:

Focal length [mm]	Field of view (H × V in [mm])	
	Object distance = 500 mm	Object distance = 1000 mm
8	811 × 542	1636 × 1093
12	536 × 358	1086 × 726
16	399 × 267	811 × 542
25	251 × 167	514 × 344
35	175 × 117	364 × 243
50	119 × 79	251 × 167
75	75 × 50	163 × 109
85	64 × 43	142 × 95
100	53 × 35	119 × 79

Table 135: Focal length versus field of view for Alvium 1800 C-2050m/c

## Alvium 1800 C-2460m/c

Values for 1800 C-2460m/c cameras with Type 1.2 (19.3 mm diagonal) sensors:

Focal length [mm]	Field of view (H × V in [mm])	
	Object distance = 500 mm	Object distance = 1000 mm
8	898 × 776	1810 × 1566
12	594 × 513	1202 × 1040
16	442 × 382	898 × 776
25	277 × 240	569 × 492
35	194 × 168	403 × 348
50	131 × 114	277 × 240
75	83 × 72	180 × 156

Table 136: Focal length versus field of view for Alvium 1800 C-2460m/c

# Access modes





This chapter includes:

Overview .....	247
Notes on GenICam for CSI-2 Access .....	247
V4L2 controls and register controls .....	249
GenICam features .....	249

## Overview

The driver for Alvium CSI-2 cameras supports different access modes to suit the various requirements of individual applications:

CSI-2 access mode	Supported models	Description
<b>Direct Register Access</b> 	All	Controls the camera by reading from and writing to registers, using an embedded board or an FPGA. See the Alvium CSI-2 Register Controls Reference document at <a href="http://www.alliedvision.com/en/support/technical-documentation/alvium-csi-2-documentation">www.alliedvision.com/en/support/technical-documentation/alvium-csi-2-documentation</a> .
<b>Video4Linux Access</b> 	All	Controls the camera by V4L2 controls, using the Allied Vision driver for CSI-2 cameras directly.  Existing PC-based machine vision applications can be scaled down to V4L2 on lean embedded systems, reducing power consumption and costs.
<b>GenICam for CSI-2 Access</b> 	All 1800 C models <sup>1</sup>	Controls the camera by GenICam features, using the Allied Vision driver for CSI-2 cameras directly.  Alvium CSI-2 cameras can be used to replace other cameras on existing PC-based machine vision applications, reducing power consumption and costs.  See the Alvium Features Reference document at <a href="http://www.alliedvision.com/en/support/technical-documentation/alvium-csi-2-documentation">www.alliedvision.com/en/support/technical-documentation/alvium-csi-2-documentation</a> .

<sup>1</sup> Alvium 1500 C models are excluded from **GenICam for CSI-2 Access**.

Table 137: Access modes overview

Figure 79 on page 248 shows how cameras are controlled using the different access modes.

## Notes on GenICam for CSI-2 Access

Before using **GenICam for CSI-2 Access**, see [GenICam for CSI-2 Access- Camera operation](#) on page 250 for smooth operation.

# Data flow

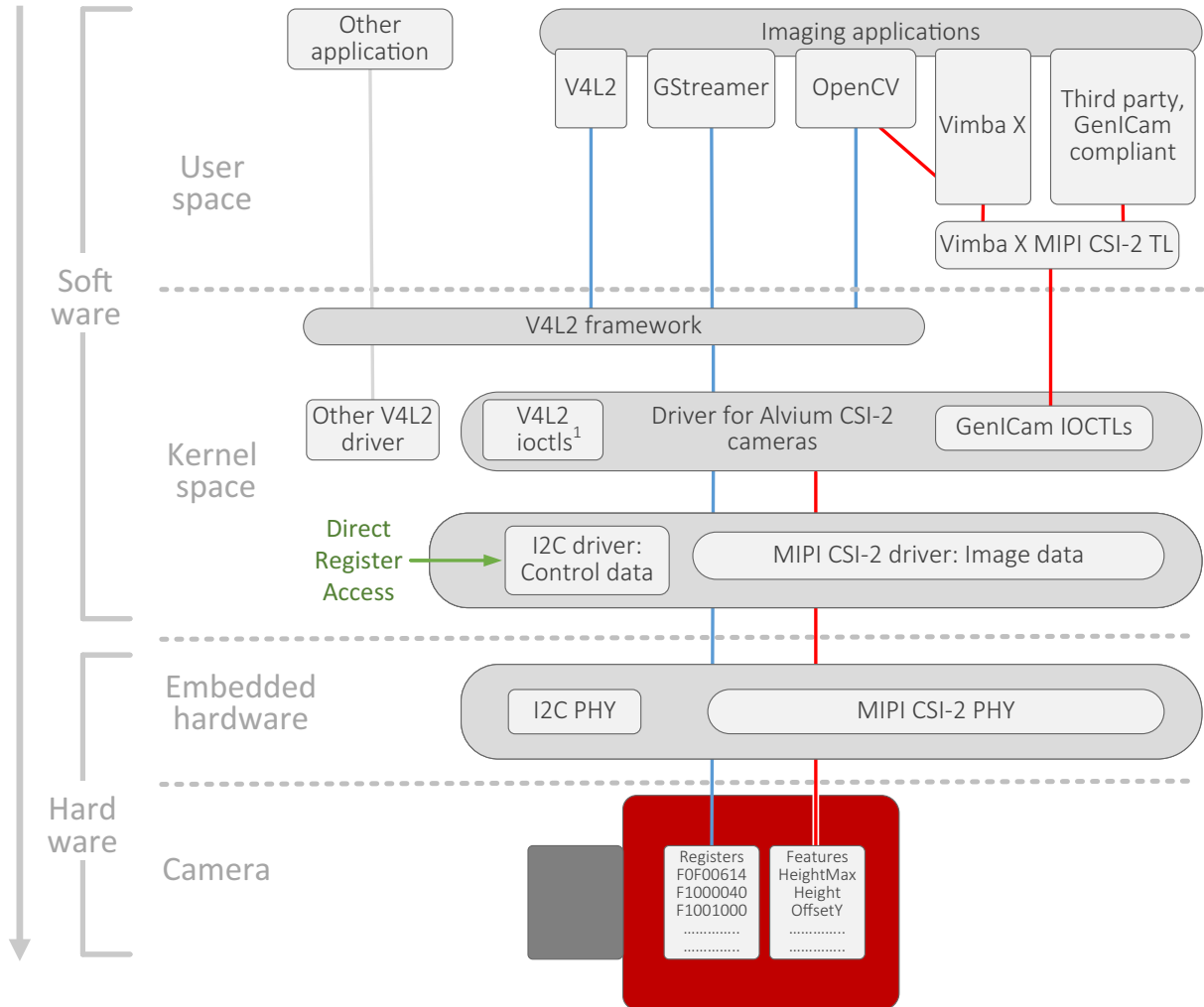

**Legend**

- Video4Linux Access
- GenICam for CSI-2 Access

<sup>1</sup> ioctls = ioctl() function

Figure 79: Camera control using the different access modes

**Direct Register Access:** Data is read from and written to registers directly.

**Video4Linux Access:** V4L2 controls registers are used.

**GenICam for CSI-2 Access:** GenICam features are used.



## V4L2 controls and register controls

**Embedded applications** often use V4L2 controls provided with the Linux kernel to operate and configure the camera.



### V4L2 controls - general information

Consider that V4L2 controls change through the Linux kernel development.

For information on such as supported Linux kernels, see <https://github.com/alliedvision>.

For a description of V4L2 controls related to the **current kernel version**, see <https://linuxtv.org>.

For embedded board adapters, see CSI-2 accessories at [www.alliedvision.com/en/support/technical-documentation/alvium-csi-2-documentation](http://www.alliedvision.com/en/support/technical-documentation/alvium-csi-2-documentation).



### V4L2 controls - reference for camera specific information

Almost every register control has an equivalent V4L2 control. For applications based on V4L2 Access, we recommend using the Direct Register Access Reference for camera specific information.

[www.alliedvision.com/en/support/technical-documentation/alvium-csi-2-documentation](http://www.alliedvision.com/en/support/technical-documentation/alvium-csi-2-documentation).

## GenICam features

**Machine vision applications** typically use GenICam SFNC features enabled by a transport layer communicating between a software development kit (SDK) and the interface driver. Selected Alvium 1800 C models support GenICam.



### GenICam features - descriptions

For GenICam feature descriptions, see the Alvium Features Reference at [www.alliedvision.com/en/support/technical-documentation/alvium-csi-2-documentation](http://www.alliedvision.com/en/support/technical-documentation/alvium-csi-2-documentation).

# GenICam for CSI-2 Access - Camera operation

## Need to restart the embedded board

**Whenever you change between different access modes:**

- You must restart the embedded board.
- Closing the application while the camera is streaming is not sufficient.

## Debouncer

If `LineDebounceMode` is enabled, an error is shown when changing the `LineDebounceDuration`. You must power cycle the camera to enable operation again.

## Device reset

The `DeviceReset` command does not work.

## User sets

Settings, including user sets are not transferred between the access modes.

Before you switch from **GenICam for CSI-2 Access** to another access mode, disable individual user sets. Set `UserSetDefault` and `UserSetSelector` to *Default* to enable factory settings.

# Installing the hardware



This chapter includes:

Touching hot cameras .....	252
Sensor damage by ESD.....	252
Scope of instructions .....	252
Bare board cameras .....	252
Connecting FPC cable and FPC connectors .....	254
Mounting the heat sink.....	256
Mounting the camera .....	257
Mounting the lens.....	262

## Touching hot cameras



### CAUTION

#### Risk of burns

A camera in operation can reach temperature levels which could cause burns.

- Wear protective gloves when you touch a camera that is heated up.
- Ensure proper cooling of the camera.

## Sensor damage by ESD



### NOTICE

#### Possible damage to the sensor

In Alvium CSI-2 cameras, sensors can be damaged by ESD. In the output image, this may become visible as bubbles or blobs, for example. For details, see [Possible damage to image sensors due to electrostatic charge](#) on page 60.

- Provide ESD protection measures in accordance with technical standards.
- Follow the instructions in [ESD](#) on page 57.

## Scope of instructions



### Software installation

#### Software downloads and documentation

This chapter describes hardware installation only. For information on supported Linux distributions and embedded boards, drivers, libraries, and programming examples, see [www.alliedvision.com/en/products/software/embedded-software-and-drivers](http://www.alliedvision.com/en/products/software/embedded-software-and-drivers).

### Hardware installation

This chapter instructs on using Alvium CSI-2 cameras safely and effectively. However, we cannot provide complete information. The MIPI CSI-2 standard does not specify electrical connections as extensively as USB or GigE standard. Therefore, instructions on camera connections can be general only.

## Bare board cameras

If you intend to design an application using bare board cameras, please consider:

- Alvium bare board cameras are not aligned. You must align these cameras into housings individually, which is extremely difficult and expensive. As a possible solution, Alvium Frame cameras provide alignment areas and holes to fit into individual housings, see [Alvium Frame- use your own optical mount](#) on page 21.

- Aligning the sensor to the lens is extremely difficult and expensive. Therefore, we recommend you to do evaluation with housed cameras first.
- Bare board cameras are specialized components. We cannot give all data needed for any application in advance.
- Please let us partner with you for bare board camera applications to ensure a successful design.

## Serial numbers of Alvium® chips and bare board cameras

Bare board cameras do not have enough space for a label with all the required information. Therefore, they are shipped with a 25 mm × 25 mm sandwich label on the blister pack. In [Figure 80](#), this label shows, for example:

- Product code: 11500 for a 1500 C-210c Bare Board camera
- Alvium® chip SN (serial number): 183603543
- Camera SN (serial number): R7QW5 as digits and 2D code.

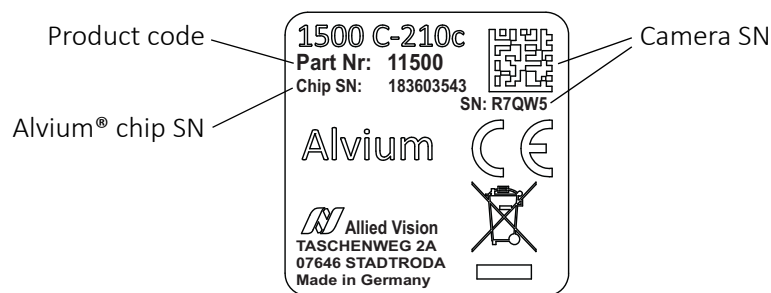

Figure 80: Sandwich label on blister packs shipped for bare board cameras

Before operating the camera, we recommend you to pull the sandwich label off the blister pack and stick it close to the camera.

If the label is lost, please read out with your smart phone the serial number of the Alvium® chip from the 2D code (a) shown in [Figure 81](#). With this number, we can look up the serial number of the camera in our database.

If your smart phone cannot read the 2D code: In [Figure 81](#), for example, the serial number (b) is 221406281.

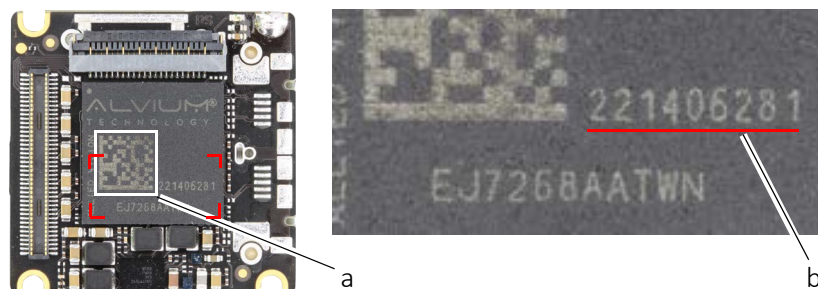

Figure 81: Alvium® chip imprint with detail view (right)

# Connecting FPC cable and FPC connectors



## Connecting Alvium CSI-2 cameras to embedded boards

- For evaluation, Allied Vision offers components to connect Alvium CSI-2 cameras to embedded boards. **Adapter boards** provide common pinning and voltage for connections to the camera using **FPC cables**. See [www.alliedvision.com/en/products/accessories](http://www.alliedvision.com/en/products/accessories).
- If you want to design your own components to connect Alvium CSI-2 cameras to embedded boards, contact your Allied Vision Sales representative or visit [www.alliedvision.com/en/support](http://www.alliedvision.com/en/support).

Figure 82 shows how the FPC cable connects to the FPC connector.

Follow the instructions to connect the FPC cable to the camera and to the embedded board.

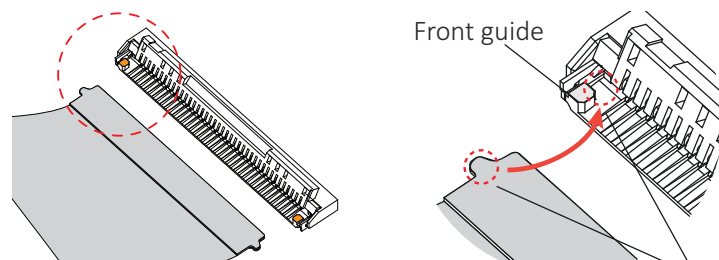

Figure 82: FPC cable and FPC connector (open position)

1. Opening the FPC connector:  
With your fingernail\*, flip the actuator to open position at 105 degrees to the PCB surface, see Figure 83.

\*Or a plastic tool, because metal tools can damage the actuator.

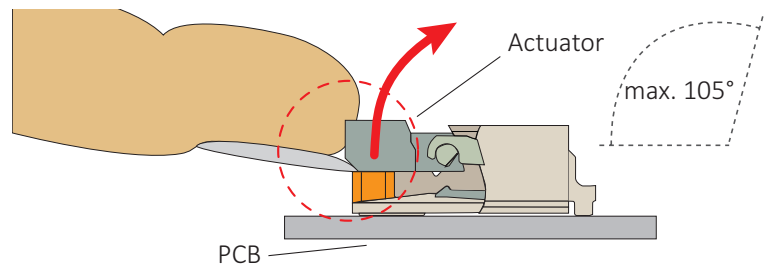

Figure 83: Opening the FPC connector

**NOTICE**
**Damage to the camera by reverse polarity**

If Alvium CSI-2 cameras are powered with reverse polarity, camera electronics is damaged.

- Before connecting camera power and I/O power, carefully read [Hirose FH55 connector pin assignment](#) on page 268.
- Connect the cable as shown in this section.

Embedded  
board or  
adapter board



Figure 84: FPC cable and image data direction

2. **Ensuring proper cable direction between host and camera**, take the FPC cable with conductors facing the FPC connector conductors (see [Figure 85](#)).

3. Inserting the FPC cable:  
At a horizontal angle of 90 degrees to the connector's rear (see [Figure 85](#)) and at a vertical angle of 12 degrees to the PCB (see [Figure 86](#)), slowly insert the FPC cable into the actuator...

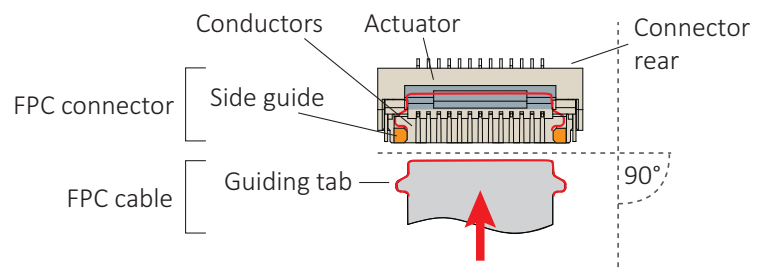

Figure 85: FPC cable and FPC connector

4. ...until cable guiding tabs are caught between connector rear and side guides (see [Figure 85](#)). Pull the cable slightly to ensure guiding tabs are properly engaged.
5. Holding the FPC cable in position, flap down the actuator to closed position (see [Figure 86](#)).

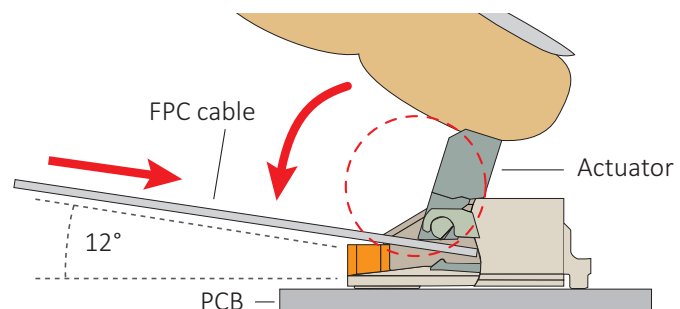

Figure 86: Engaging the FPC cable in the FPC connector

**NOTICE**
**Damage to FPC connectors**

A bended FPC cable can break the FPC connector's actuator.  
Provide sufficient strain relief at both ends of the cable.

## Mounting the heat sink

Keep the operating temperature in the specified range to enable best image quality and to protect the camera from damage. We recommend you to equip Alvium bare board and open housing cameras with heat sinks.



### Optimizing heat dissipation

For details, see the Optimum Heat Dissipation for Alvium Cameras application note at [www.alliedvision.com/en/support/technical-documentation/alvium-csi-2-documentation](http://www.alliedvision.com/en/support/technical-documentation/alvium-csi-2-documentation).



#### NOTICE

#### Damage to the camera by heat sinks mounted improperly

- Allow mechanical contact only at the cooling area.
- Avoid any mechanical stress to the sensor and electronics area.
- Avoid short circuits of the electronics components.



#### NOTICE

#### Damage to the sensor, filter, and lens by corrosive substances

Some conductive media for heat sinks contain corrosive substances that can damage optical surfaces of the sensor, filter, and lens.

- Cover the optical path of the camera when you apply heat sink compound or adhesive to prevent substances and fumes from damaging optical surfaces.
- Adhere to the instructions and safety notes provided by the manufacturer of the conductive media.



#### NOTICE

#### Damage to camera electronics

Heat sinks can cause short circuits if they are not electrically isolated.

Avoid electrical contact between electronic components by unsuitable heat sinks and thermal conductive media.

Connect components in the **cooling area** (blue area in [Figure 87](#)) to a heat sink, following the instructions of the manufacturer of the heat sink and the thermal conductive media.

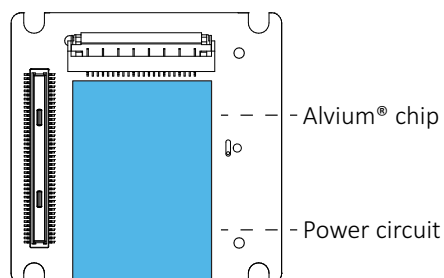

Figure 87: Cooling area for Alvium CSI-2 bare board cameras





### Heat sink compound

Because electronic parts vary in height, we have updated our recommendation:

- Use flexible heat sink compound to compensate for potential gaps between the electronic parts to be cooled and heat sinks.
- Consider 1 mm to cover for worst case scenarios.
- For details, see the Alvium STEP files at [www.alliedvision.com/en/support/alvium-step-file-downloads](http://www.alliedvision.com/en/support/alvium-step-file-downloads).

## Mounting the camera



### CAUTION

#### Injury by falling cameras or lenses

A falling camera or lens can cause injury.

- Ensure proper mounting of cameras and lenses, especially for dynamic applications.
- Mount cameras as described in the instructions.
- Always make sure the mounting threads are intact.
- Fasten screws with maximum torque, using the entire thread engagement. For less thread engagement, see [Adapting maximum torque values](#) on page 262.
- We recommend you to apply thread locking.
- Use a lens support for heavy lenses.

## Mounting bare board cameras



### Heat dissipation and electromagnetic compatibility for bare board cameras

For heat dissipation, see the Optimum Heat Dissipation for Alvium Cameras application note.

For initial guidance on electromagnetic compatibility, see the Electromagnetic Compatibility for Open Housing Alvium Cameras application note.

See [www.alliedvision.com/en/support/technical-documentation/alvium-csi-2-documentation](http://www.alliedvision.com/en/support/technical-documentation/alvium-csi-2-documentation).



### NOTICE

#### Damage to the camera by improper mounting

- Allow mechanical contact only at the mounting area.
- Avoid any mechanical stress to the sensor and the electronics area.
- Avoid short circuits of the electronics components.
- Give 2 mm minimum clearance above board components.
- Tighten screws at 0.1 Nm maximum torque.



**Sensor alignment for bare board cameras**

The sensors in Alvium bare board cameras are not aligned to a lens mount. You must align these cameras into housings individually, which can be difficult and expensive. As a possible solution, Alvium Frame cameras provide alignment areas and holes to fit into individual housings, see [Alvium Frame- use your own optical mount](#) on page 21.

Schematic drawings in [Figure 88](#) show the Alvium CSI-2 bare board camera. Only the mounting area (gray) can be used for mounting. The sensor and electronics area (red) must not be touched nor put at mechanical stress.

a = Mounting hole | b = Mounting hole and chassis ground

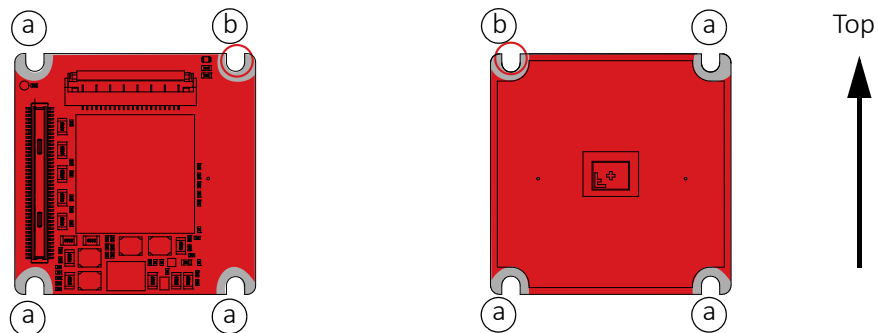

Figure 88: Mounting area of Alvium CSI-2 bare board cameras connector side (left); sensor side (right)

Mount the bare board with four M1.6 screws at 0.1 Nm maximum torque.

**Mounting open housing cameras**

**Bottom or top mounting**

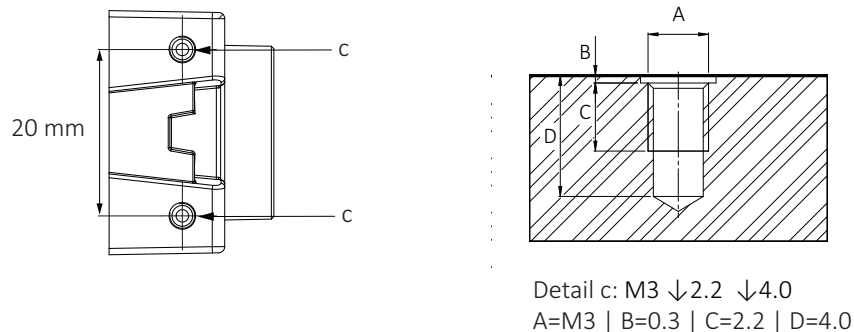

Figure 89: Top and bottom and mounting threads (c)

**The maximum torque value applies only if the entire thread engagement is used.** For other values, see [Adapting maximum torque values](#) on page 262.

1. Mount the camera to the base using suitable M3 screws at 0.51 Nm maximum torque for a thread engagement (C) of 2.2 mm between screws and mounting threads, see [Figure 89](#). For technical drawings, see [Standard Alvium: Dimensions and mass](#) on page 207.
2. Continue with [Mounting the lens](#) on page 262.

## Front mounting

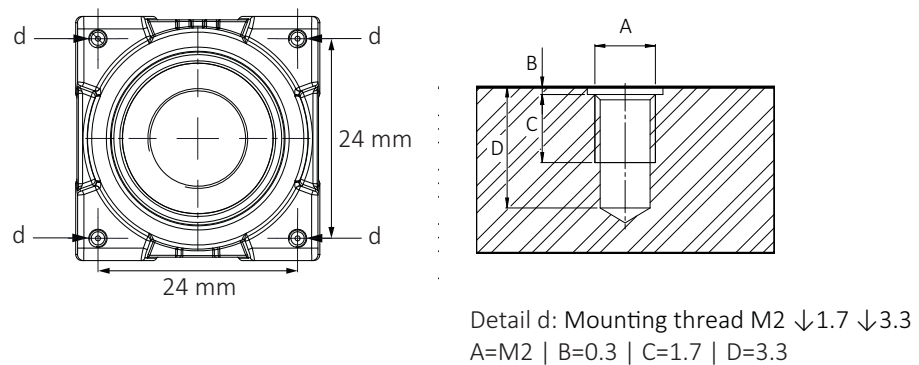

Figure 90: Camera front with mounting threads (d)

**The maximum torque value applies only if the entire thread engagement is used.** For other values, see [Adapting maximum torque values](#) on page 262.

1. Mount the camera to the base using suitable M2 screws at 0.17 Nm maximum torque for a thread engagement (C) of 1.7 mm between screws and mounting threads, see [Figure 90](#). For technical drawings, see [Standard Alvium: Dimensions and mass](#) on page 207.  
 We recommend you to additionally use bottom and top mounting threads for a more solid connection.
2. Continue with [Mounting the lens](#) on page 262.

## Mounting Alvium Frame



### CAUTION

#### Risk of cuts by sharp edges of the circular front opening

- Avoid touching these edges with your fingers.
- Wear protective gloves for handling Alvium Frame cameras with an open circular front opening.

**NOTICE**
**Damage to the sensor**

The sensor can be damaged if its surface is exposed to dirt or mechanical stress.

- Ensure that lenses or objects, such as optical elements do not exceed the specified maximum protrusion.
- Keep your fingers and tools outside the area inside the frame flange.
- Provide the following conditions to keep dirt and droplets out of the optical system of camera:
  - Dust-free environment
  - Low relative humidity
  - No condensation.

## Aligning the sensor with your optical system

Alvium Frame cameras are manufactured so that the sensor is aligned with your optical system with optimal precision. You can select between alignment methods:

**A:** Using the lateral alignment areas (1) and the front alignment area (2).

**B:** Using the front area (2) and the two alignment holes (3).

**A** Alignment by using the lateral alignment areas (1) and the front area (2)

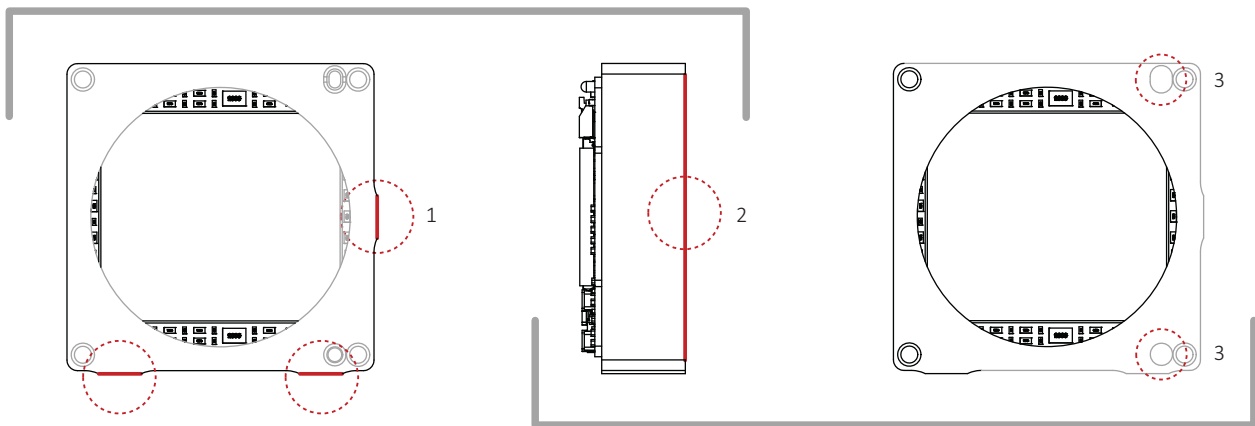

**B** Alignment by using the front area (2) and the alignment holes (3)

Figure 91: Alignment methods



### Dimensions and accuracy

For the dimensions and accuracy of the alignment areas and the alignment holes, see [Alvium Frame: Technical drawings](#) on page 218.

For the accuracy of the sensor position, see [Housed Alvium Frame: Sensor shift and rotation](#) on page 223 and [All housed Alvium CSI-2 cameras: Sensor tilt](#) on page 223.

When you design Alvium Frame cameras into your system, observe values for:

- Flange focal distance, optical: 3.576 mm
- Maximum protrusion of 1.5 mm into the frame measured from the front area (2).

## Mounting Alvium Frame

Especially for dynamic applications with high acceleration, mount the camera using all 4 mounting threads.

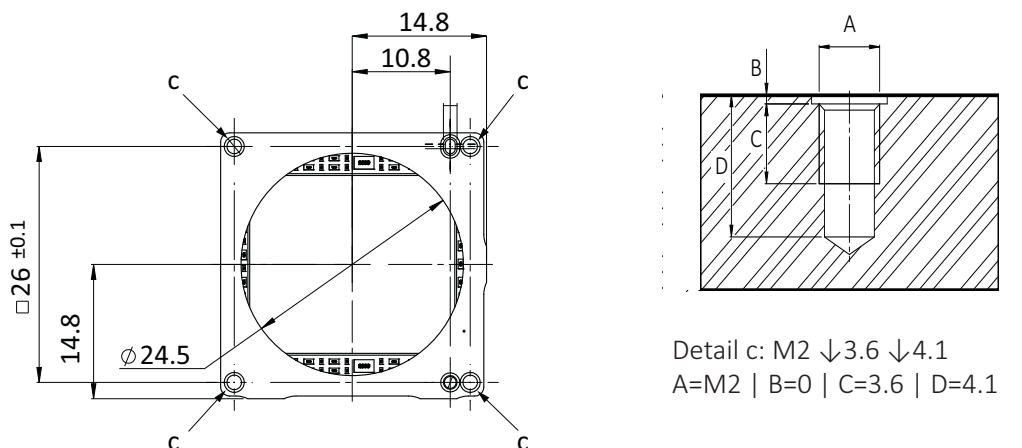

Figure 92: Mounting threads Alvium Frame

**The maximum torque value applies only if the entire thread engagement is used.** For other values, see [Adapting maximum torque values](#) on page 262. For technical drawings, with further values and tolerances, and references for alignment, see [Alvium Frame: Technical drawings](#) on page 218.

As shown in [Figure 92](#), mount the camera to the base using suitable M2 screws for the 4 mounting threads: At 0.4 Nm maximum torque for a thread engagement (C) of 3.6 mm between screws and mounting threads.

## Adapting maximum torque values

This is a general example. Use the corresponding values for your camera. The total screw length composes of the mounting holes length and the height of your mounting base. For using less than the recommended length of thread engagement, calculate maximum torque as follows:

$$\frac{\text{Current length of thread engagement}}{\text{Length of thread engagement in table}} \times \text{Torque in table} = \text{Current torque}$$

Example for a length of thread engagement of **1.4 mm** instead of 1.7 mm:  
**1.4 mm / 1.7 mm × 0.17 Nm = 0.14 Nm**

Thread group	Thread position	Thread type	Total protrusion	Length of thread engagement	Maximum torque
d	Front mounting	M2	2 mm	1.7 mm	0.17 Nm
d	Front mounting	M2	2 mm	<b>1.4 mm</b>	<b>0.14 Nm</b>

Table 138: Adjusting maximum torque values

To ensure that the screws do not become loose over time, we recommend you to use means for securing screws, such as screw locking varnish.



### Tripod adapter

For more information, see [www.alliedvision.com/en/products/accessories](http://www.alliedvision.com/en/products/accessories).

## Mounting the lens

Observe the following notes before you mount lenses to Alvim CSI-2 cameras.



### CAUTION

#### Injury by falling cameras or lenses

A falling camera or lens can cause injury.

- Ensure proper mounting of cameras and lenses, especially for dynamic applications.
- Mount cameras as described in the instructions.
- Use a lens support for heavy lenses.



### CAUTION

#### Risk of cuts by sharp edges of lens mounts

The threads of the lens mount can have sharp edges.

Be careful when mounting or unmounting lenses.

**NOTICE**
**Damage to sensor, optics, or electronics by unsuitable lenses**

The sensor, filter, lens, or electronics can be damaged if a lens exceeding maximum protrusion is mounted to the camera.

- Use lenses only up to the specified maximum protrusion, see [Maximum protrusion for front mounts](#) on page 220.
- S-Mount lenses must be screwed into the camera at less than maximum protrusion (11.0 mm), see [Mounting and focusing S-Mount lenses](#) on page 263.
- Avoid short S-Mount lenses falling into the camera.

## Mounting and focusing S-Mount lenses

**Allied Vision S-Mount lenses**

For technical data of Allied Vision S-Mount lenses with dedicated operating instructions, see the S-Mount Lenses User Guide at [www.alliedvision.com/fileadmin/content/documents/products/accessories/lenses/Allied\\_Vision/User\\_Guide/S-Mount-Lenses\\_User-Guide.pdf](http://www.alliedvision.com/fileadmin/content/documents/products/accessories/lenses/Allied_Vision/User_Guide/S-Mount-Lenses_User-Guide.pdf).

This section instructs how to use S-Mount lenses with your camera safely.

S-Mount lenses are screwed into the mount to adjust focus. Vibration moves lenses out of position. Several techniques can be used to fasten S-Mount lenses in focus. We recommend using fixing nuts. See instructions in this section.

**Drawings and fixing nuts**

Drawings in the instructions are schematic.

Several manufacturers offer various types of S-Mount fixing nuts. The type shown in the instructions drawings is an example.

We recommend using pinch nose pliers to tighten fixing nuts.

Figure 93 shows how fixing nuts lock S-Mount lenses. Follow the instructions to lock the lens in focus position.

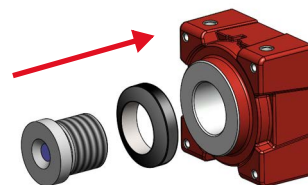

Figure 93: Fixing nut locking an S-Mount lens

**NOTICE**
**Damage to sensor, optics, or electronics by improper handling**

If an S-Mount lens is screwed against the sensor or electronics, sensor, lens, or electronics can be damaged.

- Screw in the lens at less than 11.0 mm maximum protrusion.
- Follow the instructions carefully.

**Determining the allowed range for the position of the lens**

1. Measure the length of the lens.
2. Calculate:  $a = c - b$   
 a: length of the mounted lens, measured from lens mount front flange  
 b: maximum protrusion (11.0mm)  
 c: length of the lens

See [Maximum protrusion for front mounts](#) on page 220.

3. Set a gauge to the length of (a).

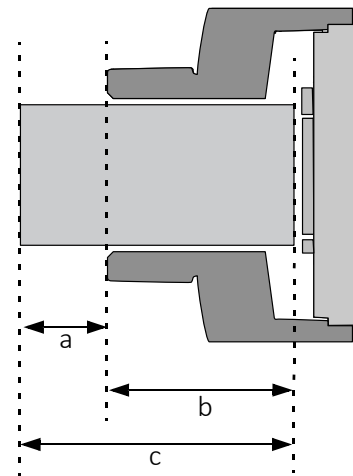

Figure 94: S-Mount lens and protrusion

**Mounting the fixing nut to the lens**

4. Screw the fixing nut clockwise onto the lens until you can hold the front part (d) of the lens with your finger tips.



Figure 95: Lens and fixing nut

**Focusing the lens**

5. **Checking (a) with a gauge**, slowly screw the lens clockwise into the lens mount until the image is roughly in focus.
6. Slowly screw in and unscrew the lens until you have found the most accurate focus.

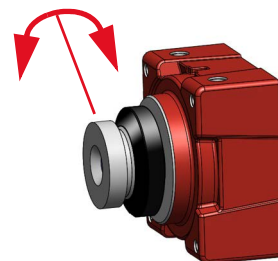

Figure 96: Adjusting focus



**NOTICE**
**Damage to lens threads and fixing nut by excessive force**

If the fixing nut is screwed with too much force, threads are worn out and the lens cannot be locked anymore.

Screw fixing nuts hand tight to keep the lens in a fixed position.

**Locking focus**

Pinch nose pliers are used to screw the fixing nut:

7. Holding the lens in position with one hand, screw the fixing nut clockwise against the lens mount until you feel the lens is locked.

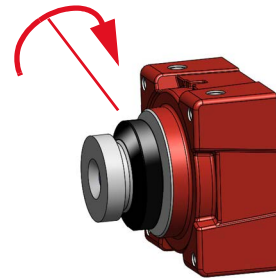

Figure 97: Tightening the fixing nut

**Checking focus is set and locked properly**

8. Check No.1: Try to rotate the lens with little force in both directions to ensure the lens is safely locked in position.

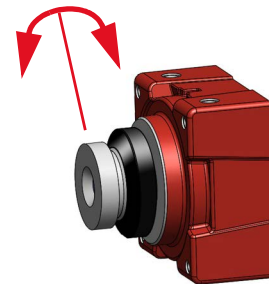

Figure 98: Checking lens is safely locked

9. Check No. 2: S-Mount thread allows a slightly tilted lens position. In this case, focus for a common object plane varies over the image plane.

**If focus is constant** over the image plane, you are done.

**If focus varies** over the image plane, the lens is tilted. Continue with 10.

10. Loosen the fixing nut.

11. Continue with 6.

The lens is locked in focus and ready for operation.

# Camera interfaces

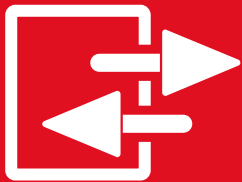

This chapter includes:

Standard Alvium and Alvium Frame: Connections .....	267
Alvium Flex: Connections .....	270
All Alvium CSI-2: Connections .....	273

# Standard Alvium and Alvium Frame: Connections

## Recommended accessories



### Compatible electronics accessories

For more information, see [www.alliedvision.com/en/products/accessories](http://www.alliedvision.com/en/products/accessories).

## Back panel

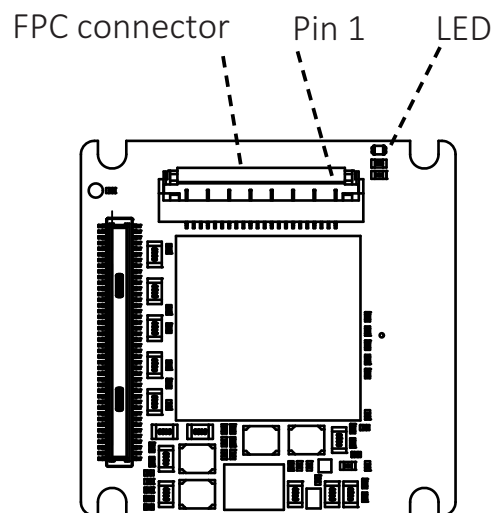

*Figure 99: Standard Alvium and Alvium Frame camera back panel*

For connector pin assignment, see [Hirose FH55 connector pin assignment](#) on page 268.

## Hirose FH55 connector pin assignment

Standard Alvium CSI-2 cameras have a 22-pin Hirose FH55-22S-0.5SH connector.



### NOTICE

#### Damage to the camera by reverse polarity

If Alvium CSI-2 cameras or camera I/Os are powered with reverse polarity, camera electronics can be damaged.

Observe polarity for camera and I/O power.



### NOTICE

#### Damage by serial communication voltage levels

If you are using serial communication (UART, similar to RS232), keep voltage levels in the range defined in [Table 139](#) on page 269. Typical RS232 voltage levels (such as  $\pm 10$  VDC) are not supported without external circuitry.



#### More information on Hirose FH55-22S-0.5SH connector

For technical data and more instructions on the Hirose FH55-22S-0.5SH connector, see the manufacturer data sheet at [www.hirose.com](http://www.hirose.com).

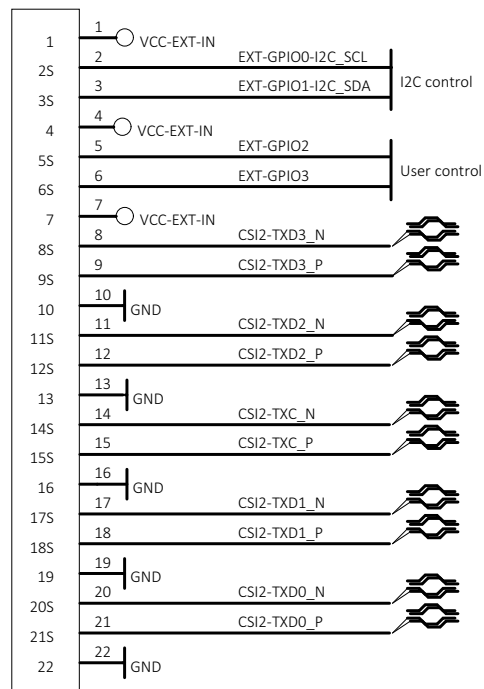

Figure 100: Standard Alvium and Alvium Frame - Hirose FH55-22S-0.5SH connector pin assignment

Pin	Signal	Direction	Level	Description
1	VCC-EXT-IN	PWR IN	4.5 to 5.5 VDC	Power supply voltage Maximum input current: 1.5 A
2	EXT-GPIO0-I2C_SCL	IN/OUT	$U_{in} (low) = -0.3$ to 0.8 VDC $U_{in} (high) = 2.0$ to 5.5 VDC $U_{out} (low) = 0$ to 0.4 VDC $U_{out} (high) = 2.4$ to 3.3 VDC at 12 mA	I2C Control Internal pull-up resistor: 33 to 63 k $\Omega$
3	EXT-GPIO1-I2C_SDA	IN/OUT	See Pin 2, EXT-GPIO0	
4	VCC-EXT-IN	PWR IN	4.5 to 5.5 VDC	Power supply voltage Maximum input current: 1.5 A
5	EXT-GPIO2	IN/OUT	$U_{in} (low) = -0.3$ to 0.8 VDC $U_{in} (high) = 2.0$ to 5.5 VDC $U_{out} (low) = 0$ to 0.4 VDC $U_{out} (high) = 2.4$ to 3.3 VDC at 12 mA	GPIO Internal pull-up resistor: 33 to 63 k $\Omega$
6	EXT-GPIO3	IN/OUT	See Pin 5, EXT-GPIO2	
7	VCC-EXT-IN	PWR IN	4.5 to 5.5 VDC	Power supply voltage Maximum input current: 1.5 A
8	CSI2-TXD3_N	OUT	According to MIPI CSI-2 D-PHY V1.1	CSI-2 TX data lane 3 negative rail
9	CSI2-TXD3_P	OUT	According to MIPI CSI-2 D-PHY V1.1	CSI-2 TX data lane 3 positive rail
10	GND	PWR	0 VDC	Power supply ground
11	CSI2-TXD2_N	OUT	According to MIPI CSI-2 D-PHY V1.1	CSI-2 TX data lane 2 negative rail
12	CSI2-TXD2_P	OUT	According to MIPI CSI-2 D-PHY V1.1	CSI-2 TX data lane 2 positive rail
13	GND	PWR	0 VDC	Power supply ground
14	CSI2-TXC_N	OUT	According to MIPI CSI-2 D-PHY V1.1	CSI-2 TX clock lane negative rail
15	CSI2-TXC_P	OUT	According to MIPI CSI-2 D-PHY V1.1	CSI-2 TX clock lane positive rail
16	GND	PWR	0 VDC	Power supply ground
17	CSI2-TXD1_N	OUT	According to MIPI CSI-2 D-PHY V1.1	CSI-2 TX data lane 1 negative rail
18	CSI2-TXD1_P	OUT	According to MIPI CSI-2 D-PHY V1.1	CSI-2 TX data lane 1 positive rail
19	GND	PWR	0 VDC	Power supply ground
20	CSI2-TXD0_N	OUT	According to MIPI CSI-2 D-PHY V1.1	CSI-2 TX data lane 0 negative rail
21	CSI2-TXD0_P	OUT	According to MIPI CSI-2 D-PHY V1.1	CSI-2 TX data lane 0 positive rail
22	GND	PWR	0 VDC	Power supply ground

Table 139: Standard Alvium and Alvium Frame - Hirose FH55-22S-0.5SH pin assignment

# Alvium Flex: Connections

## Observe for DF40C-50DP-0.4V connectors

Because using the Hirose DF40C-50DP-0.4V connector on Alvium Flex cameras is a novelty, no standard can be applied for the pinning. Therefore, connect your individual electronic parts only if you are an electronics expert. Otherwise, we recommend you to use boards and cables offered by Allied Vision for testing and evaluation, but also for final applications.



### Alvium Flex accessories

See the Alvium Flex Design and Accessory Guide at [www.alliedvision.com/en/support/technical-documentation/alvium-csi-2-documentation](http://www.alliedvision.com/en/support/technical-documentation/alvium-csi-2-documentation).

## Back panel

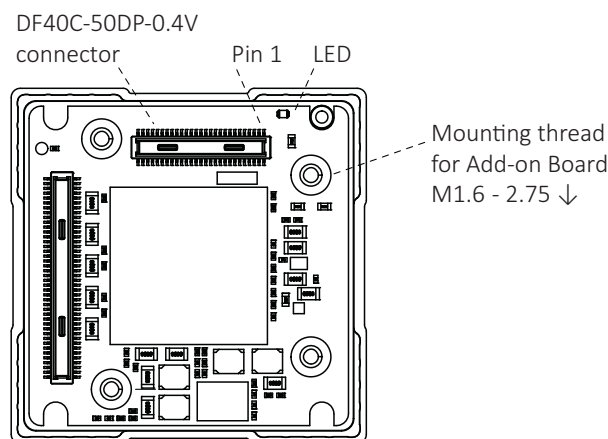

Figure 101: Alvium Flex camera back panel

## DF40C-50DP-0.4V connector details

Alvium CSI-2 Flex cameras have a 50-pin Hirose DF40C-50DP-0.4V connector.



### NOTICE

#### Damage to the camera by reverse polarity

If Alvium CSI-2 cameras or camera I/Os are powered with reverse polarity, camera electronics can be damaged.

- Use Alvium Flex accessories by Allied Vision.
- Observe polarity for camera and I/O power.

**NOTICE**
**Damage by serial communication voltage levels**

If you are using serial communication (UART, similar to RS232), keep voltage levels in the range defined in [Table 139](#) on page 269. Typical RS232 voltage levels (such as  $\pm 10$  VDC) are not supported without external circuitry.

**More information on Hirose DF40C-50DP-0.4V connector**

- For instructions and electronic specifications of Alvium Flex accessories, see the Alvium Flex Design and Accessory Guide at [www.alliedvision.com/en/support/technical-documentation/alvium-csi-2-documentation](http://www.alliedvision.com/en/support/technical-documentation/alvium-csi-2-documentation).
- For technical data and more instructions on the Hirose DF40C-50DP-0.4V connector, see the manufacturer data sheet at [www.hirose.com](http://www.hirose.com).

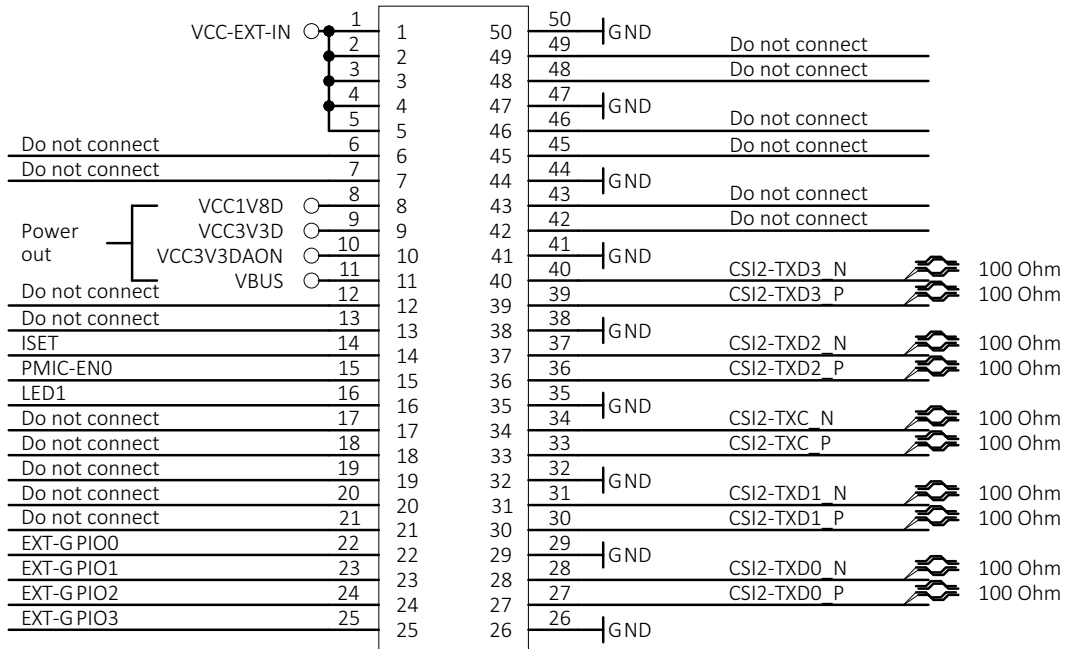

Figure 102: Hirose DF40C-50DP-0.4V connector pin assignment

Pin	Signal	Direction	Level	Description
1 to 5	VCC-EXT-IN	PWR IN	4.5 to 5.5 VDC	Power supply voltage Maximum input current: 1.5 A
6				Do not connect
7				Do not connect
8	VCC1V8D	PWR OUT	max. 1.8 VDC	Power output Please contact Allied Vision Support if you want to use PWR OUT.
9	VCC3V3D	PWR OUT	max. 3.3 VDC	
10	VCC3V3DAON	PWR OUT	max. 3.3 VDC	
Only signals shown in green must be connected for basic camera operation.				

Table 140: Hirose DF40C-50DP-0.4V connector pin assignment (sheet 1 of 3)

Pin	Signal	Direction	Level	Description
11	VBUS	PWR OUT	4.0 to 5.5 VDC	Power output Please contact Allied Vision Support if you want to use PWR OUT.
12	Do not connect			
13	Do not connect			
14	ISET	IN	Not applicable	To increase the camera's default internal current limit of 900 mA, connect an 820 Ω resistor to GND.
15	PMIC-ENO	IN	$U_{in} \text{ (low)} = -0.3 \text{ to } 0.4 \text{ VDC}$ $U_{in} \text{ (high)} = 1.4 \text{ to } 5.5 \text{ VDC}$	Camera power supply enable switch (active high, internal 100 kΩ pull-up resistor, default on)
16	LED1	OUT	3.3 VDC at 4 mA	Status LED output
17	Do not connect			
18	Do not connect			
19	Do not connect			
20	Do not connect			
21	Do not connect			
22	EXT-GPIO0- I2C_SCL	IN/OUT	$U_{in} \text{ (low)} = -0.3 \text{ to } 0.8 \text{ VDC}$ $U_{in} \text{ (high)} = 2.0 \text{ to } 5.5 \text{ VDC}$ $U_{out} \text{ (low)} = 0 \text{ to } 0.4 \text{ VDC}$ $U_{out} \text{ (high)} = 2.4 \text{ to } 3.3 \text{ VDC}$ at 12 mA	I2C Control Internal pull-up resistor: 33 to 63 kΩ
23	EXT-GPIO1- I2C_SDA	IN/OUT		See Pin 22, EXT-GPIO0
24	EXT-GPIO2	IN/OUT	$U_{in} \text{ (low)} = -0.3 \text{ to } 0.8 \text{ VDC}$ $U_{in} \text{ (high)} = 2.0 \text{ to } 5.5 \text{ VDC}$ $U_{out} \text{ (low)} = 0 \text{ to } 0.4 \text{ VDC}$ $U_{out} \text{ (high)} = 2.4 \text{ to } 3.3 \text{ VDC}$ at 12 mA	GPIO Internal pull-up resistor: 33 to 63 kΩ
25	EXT-GPIO3	IN/OUT		See Pin 24, EXT-GPIO2
26	GND	PWR	0 VDC	Power supply ground
27	CSI2-TXD0_P	OUT	According to MIPI CSI-2 D-PHY V1.1	CSI-2 TX data lane 0 positive rail
28	CSI2-TXD0_N	OUT		CSI-2 TX data lane 0 negative rail
29	GND	PWR	0 VDC	Power supply ground
30	CSI2-TXD1_P	OUT	According to MIPI CSI-2 D-PHY V1.1	CSI-2 TX data lane 1 positive rail
31	CSI2-TXD1_N	OUT		CSI-2 TX data lane 1 negative rail
32	GND	PWR	0 VDC	Power supply ground
33	CSI2-TXC_P	OUT	According to MIPI CSI-2 D-PHY V1.1	CSI-2 TX clock lane positive rail
34	CSI2-TXC_N	OUT		CSI-2 TX clock lane negative rail
35	GND	PWR	0 VDC	Power supply ground
36	CSI2-TXD2_P	OUT	According to MIPI CSI-2 D-PHY V1.1	CSI-2 TX data lane 2 positive rail
37	CSI2-TXD2_N	OUT		CSI-2 TX data lane 2 negative rail
38	GND	PWR	0 VDC	Power supply ground
39	CSI2-TXD3_P	OUT	According to MIPI CSI-2 D-PHY V1.1	CSI-2 TX data lane 3 positive rail
40	CSI2-TXD3_N	OUT		CSI-2 TX data lane 3 negative rail

Table 140: Hirose DF40C-50DP-0.4V connector pin assignment (sheet 2 of 3)





Pin	Signal	Direction	Level	Description
41	GND	PWR	0 VDC	Power supply ground
42				Do not connect
43				Do not connect
Only signals shown in green must be connected for basic camera operation.				
45				Do not connect
46				Do not connect
47	GND	PWR	0 VDC	Power supply ground
48				Do not connect
49				Do not connect
50	GND	PWR	0 VDC	Power supply ground
Only signals shown in green must be connected for basic camera operation.				

Table 140: Hirose DF40C-50DP-0.4V connector pin assignment (sheet 3 of 3)

## All Alvium CSI-2: Connections

Signal	LineSelector (GenICam)	UART line
EXT-GPIO 0	Line0	Not applicable
EXT-GPIO 1	Line1	Not applicable
EXT-GPIO 2	Line2	UART Tx
EXT-GPIO 3	Line3	UART Rx

Table 141: Value settings to control I/Os using the LineSelector feature

Feature descriptions
 <p>For more information in LineSelector and SerialHub features, see the Alvium Features Reference at <a href="http://www.alliedvision.com/en/support/technical-documentation/alvium-csi-2-documentation">www.alliedvision.com/en/support/technical-documentation/alvium-csi-2-documentation</a>.</p> 

## Non-isolated, programmable GPIOs



### Available GPIOs

From four GPIOs, I2C uses two GPIOs for control traffic. Therefore, only two GPIOs are available for user control of the camera.



### I/O cables maximum length

The maximum length for I/O cables must not exceed 30 m.

## GPIOs description

The camera has four non-isolated GPIOs that can be configured by software to act as inputs or outputs.

Alvium GPIOs use the push-pull technology to switch the signal level between low and high. For low levels, the signal is "pulled" down towards ground level. For high levels, the signal is "pushed" up towards VCC level.

Alvium GPIOs feature the CMOS push-pull output drivers and Schmitt trigger inputs with an internal pull-up resistor and a filter circuit, shown in [Figure 103](#). The push-pull GPIOs are able to source or sink current from an external pin.

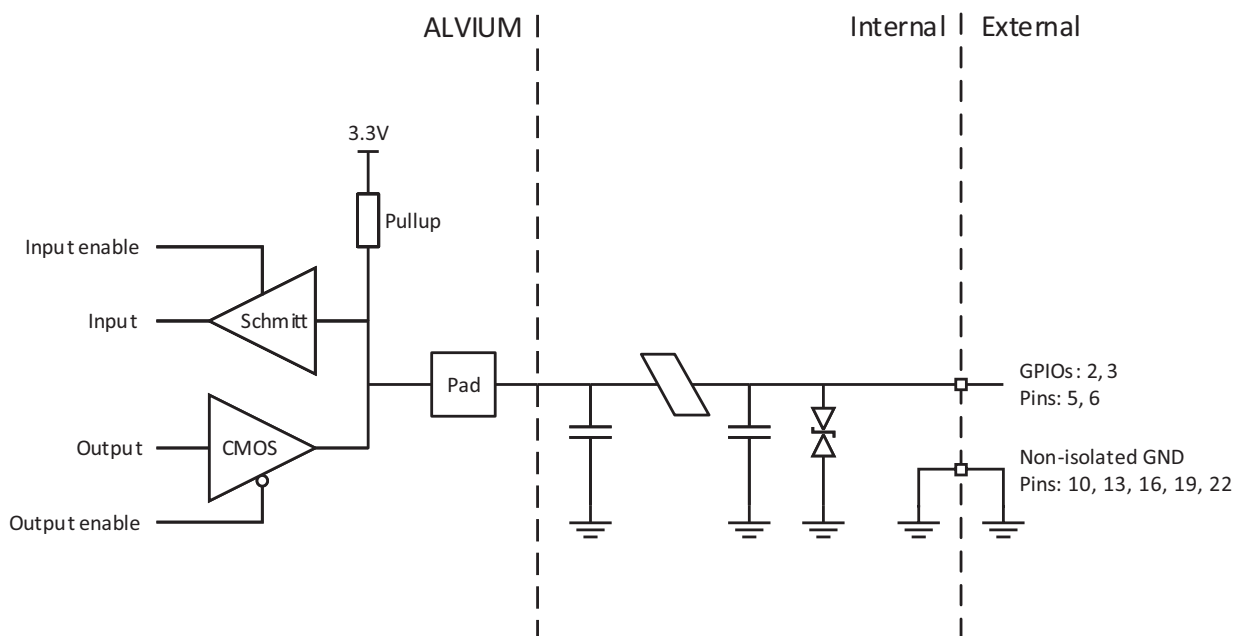

Figure 103: GPIOs block diagram

## Input levels

The GPIOs can be connected directly to the system controlling the camera for voltages up to 5.5 VDC. An external resistor is not necessary.



### NOTICE

#### Damage to the camera by high input voltage

Exceeding maximum input voltage can damage the camera.  
Keep maximum input voltage below 5.5 VDC.

Parameter	Value
$U_{in}$ (low)	-0.3 to 0.8 VDC
$U_{in}$ (high)	2.0 to 5.5 VDC
Undefined levels	0.8 to 2.0 VDC

Table 142: GPIOs as input, voltage levels

## Output levels



### NOTICE

#### Damage to the camera by high output current or voltage

The camera can be damaged when connected to a device that exceeds the specified maximum current or voltage. Consider maximum values:

- Max. current = 12 mA per output
- Max. Out VCC = 3.3 VDC

Parameter	Value
External output voltage $U_{out}$ (low)	0 to 0.4 VDC
External output voltage $U_{out}$ (high)	2.4 to 3.3 VDC
Undefined levels	0.4 to 2.4 VDC
Maximum external output voltage	3.3 VDC
Maximum output current	12 mA

Table 143: GPIOs as output, current and voltage levels



#### Output voltage for $U_{Out}$ (high) = On state

The voltage level in the On state depends on the load current. Higher currents yield lower voltage.

## Status LED

Alvium CSI-2 cameras have a green status LED. The following table describes the flashing pattern indicating different events. Inverse flashing: If the LED is already on, it is switched off for a short time.

### Normal operation



LED codes	Behavior	Status
	Continuously active	Power on or idle state
	Irregular flashing	Command or image traffic, such as for camera startup
	Four short flashes and code sequence	Error state

Table 144: LED codes for normal operation

### Error conditions

Four short flashes followed by another sequence indicate errors. In this case, try the following to get the camera back to normal operation:

1. Restart the camera.
2. If the LED again indicates error state after restart, please contact support at [www.alliedvision.com/en/about-us/contact-us/technical-support-repair/-rma](http://www.alliedvision.com/en/about-us/contact-us/technical-support-repair/-rma).

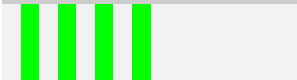
# Triggering and timings



This chapter includes:

Availability of triggering controls for CSI-2 .....	278
Trigger signal flow .....	278
Trigger latency .....	279
Triggering with rolling shutter cameras .....	279

## Availability of triggering controls for CSI-2

Alvium CSI-2 cameras can be triggered by all embedded boards supported by Alvium CSI-2 cameras.



### Downloads

Some boards have limitations. For more information, go to the examples repository on <https://github.com/alliedvision>.

Use the NVIDIA Jetson driver provided at [https://github.com/alliedvision/linux\\_nvidia\\_jetson](https://github.com/alliedvision/linux_nvidia_jetson)



### Trigger controls description

For more information on triggering controls, see the Alvium CSI-2 Register Controls Reference at [www.alliedvision.com/en/support/technical-documentation/alvium-csi-2-documentation](http://www.alliedvision.com/en/support/technical-documentation/alvium-csi-2-documentation).

The current firmware supports Frame Start Trigger controls by software or external line signals. Other trigger controls known from GenICam features are not supported.

Some controls may not be supported by all camera models.

## Trigger signal flow

Figure 104 shows an ideal diagram for the trigger signal flow for Alvium CSI-2 cameras. The external signal can be a physical source, such as light barrier as hardware trigger or a software trigger. This external signal starts the exposure of a frame. The end of exposure starts the readout. High levels show the active state of a signal. The different **signals display the workflow**, not user controls.

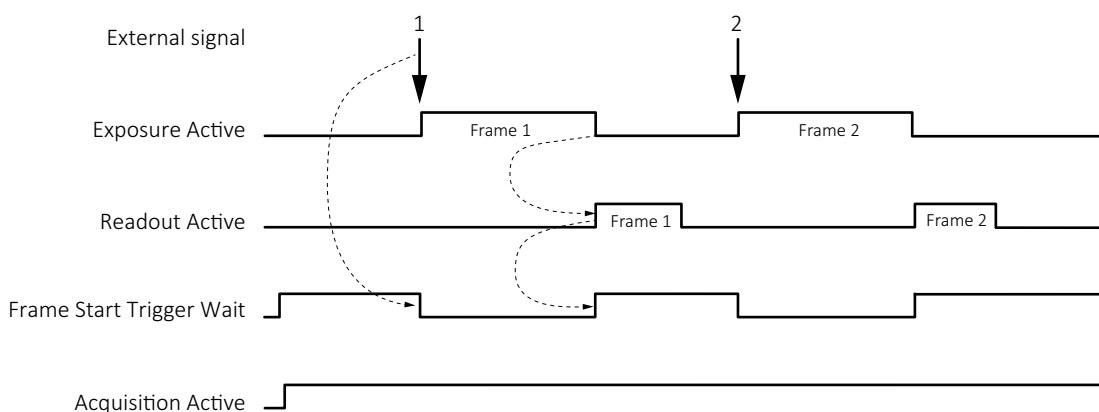

Figure 104: Trigger signal flow

Term	Description
External signal	Electrical trigger signal starting the signal flow
Exposure Active	Exposing a frame
Readout Active	Reading out a frame
Frame Start Trigger Wait	Waiting for a trigger
Acquisition Active	Enables frame acquisition: Expose, read out data, or wait for triggers.

Table 145: Trigger signal flow, legend

## Trigger latency

In theory, a trigger creates an immediate response of the camera, depending on the cable length. In practice, the computer may add a delay that is mostly unpredictable. In addition, camera electronics and sensors have a delay.

Rolling shutter (RS) cameras in this document also have exposure delay, depending on camera settings, see [Triggering with rolling shutter cameras](#) on page 279.



## Trigger features and UserSetDefault

See [Trigger features and UserSetDefault](#) on page 225.

## Triggering with rolling shutter cameras

This section describes triggering behavior for **1500 C-210m/c** and **C-500m/c**, and for **1800 C-1240m/c** and **C-2050m/c**. [Figure 105](#) shows how an external signal triggers exposure and readout for cameras with rolling shutter (RS) sensors. Like for global shutter (GS) sensors, readout has a constant duration, acquisition must be active to enable exposure, the end of exposure starts readout.

Rolling shutter (RS) sensors run in cycles where [readout area](#) equals [exposure area](#). Overlapping triggering is not supported. If exposure time is shorter than readout time, exposure starts with a delay:

Exposure start delay = exposure area – exposure time.



**Signals and controls**

The signals displayed in Figure 105 represent logical states, not user controls.

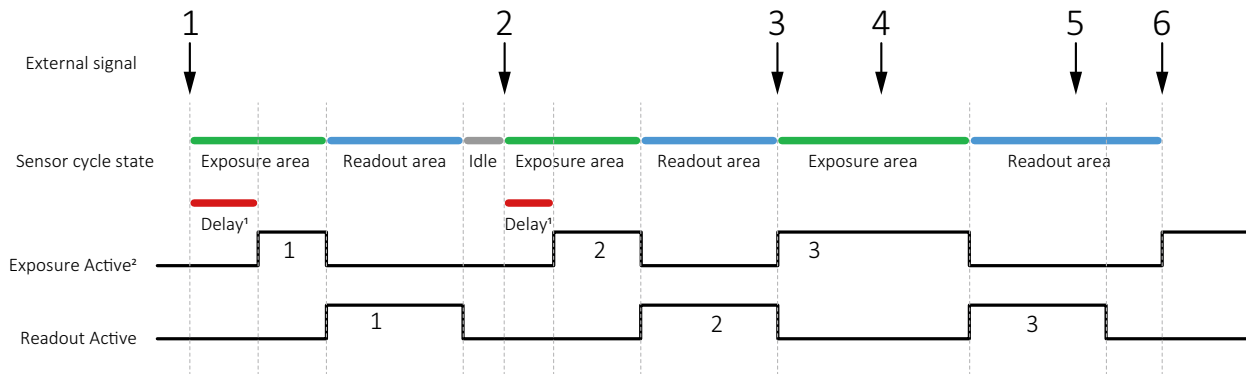

<sup>1</sup>Exposure start delay

<sup>2</sup>Active when all lines are exposing simultaneously. Therefore, Exposure Active is shorter than Exposure Time.

Figure 105: Triggering rolling shutter (RS) cameras

No	Conditions	Results
1	Exposure time is shorter than readout time.	Trigger 1 starts exposure 1 with a delay
2	Exposure time is shorter than readout time, but <b>longer</b> than for exposure 1.	Trigger 2 starts exposure 2 with a delay <b>shorter</b> than for exposure 1.
3	Exposure time is longer than readout time	Trigger 3 starts exposure time without a delay. Because the <b>exposure area</b> is longer, also the <b>readout area</b> is longer than for triggers 1 and 2
4	<b>Exposure area</b> is ongoing.	Trigger 4 is ignored.
5	<b>Readout area</b> is ongoing	Trigger 5 is ignored.
6	<b>Readout area</b> is finished. Exposure time is longer than readout time.	Trigger 6 starts exposure 6 without a delay

Table 146: Triggering conditions and results

**TriggerSelector values for rolling shutter (RS) cameras**

Cameras with rolling shutter (RS) **can** be triggered using *AcquisitionStart*, *AcquisitionEnd*, or *FrameStart* for TriggerSelector.

Cameras with rolling shutter (RS) **cannot** be triggered using *ExposureStart* or *ExposureEnd* for TriggerSelector.





#### Frame rates in triggered mode

When rolling shutter cameras are operated in triggered mode, the values for maximum frame rate reached in free run mode are cut in half.

### Ignored triggers

Alvium 1500 C-210m/c, C-500m/c, 1800 C-1240m/c, 1800 C-2050m/c

Changing parameters while acquisition is active leads to ignored triggers until the parameters get active.

## Trigger delay with 1500 C-120 cameras

If sensor related parameters are changed **directly before** sending an external trigger, the trigger delay can be increased. This relates to [Frame rate jitter](#) on page 291.

# Firmware update



This chapter describes how firmware is updated on Alvium CSI-2 cameras:

Please note.....	283
Preparing firmware updates .....	283
Updating the firmware.....	284
Error handling .....	286

## Please note

You should update firmware only to change camera functions or fix known issues.

**Consider:** Any firmware update may not only add new features to a camera or fix known issues. It may also replace previous features or change camera characteristics. See firmware release notes for details.



### Keep the camera connected

- Keep the camera and the computer running while you are executing a firmware update.
- If the camera is powered down during firmware update, the camera firmware may get into a non-functional state.



### Use only suitable firmware

If unsuitable firmware is used, the camera may get into a non-functional state.

- Only update to newer versions. Do not downgrade firmware to an older version, unless this has been explicitly communicated.
- We recommend updating the firmware to the next increment version only. Skipping versions may cause issues.

## Preparing firmware updates

1. Download and install **Vimba X**.  
The download includes **Vimba X** documentation.
2. Download the firmware (AVF file).



### Downloads

- For **Vimba X**, see [www.alliedvision.com/en/products/software/vimba-x-sdk](http://www.alliedvision.com/en/products/software/vimba-x-sdk).
- For firmware updates, see [www.alliedvision.com/en/support/firmware](http://www.alliedvision.com/en/support/firmware).

3. Connect your Alvim camera to the embedded board.
4. Execute ELF file of the firmware updater.  
The **Vimba X Firmware Updater** window opens, displaying your camera and the installed firmware version.
5. Continue with [Updating the firmware](#) on page 284.

# Updating the firmware



### Screenshots

The following instruction shows the firmware update on a **Linux** system. On **Linux** systems with other skins and on **Windows**, the GUI will look different.

If you are using command lines, you can derive the workflow from this instruction.

1. Click **Open** to select the firmware for the update.

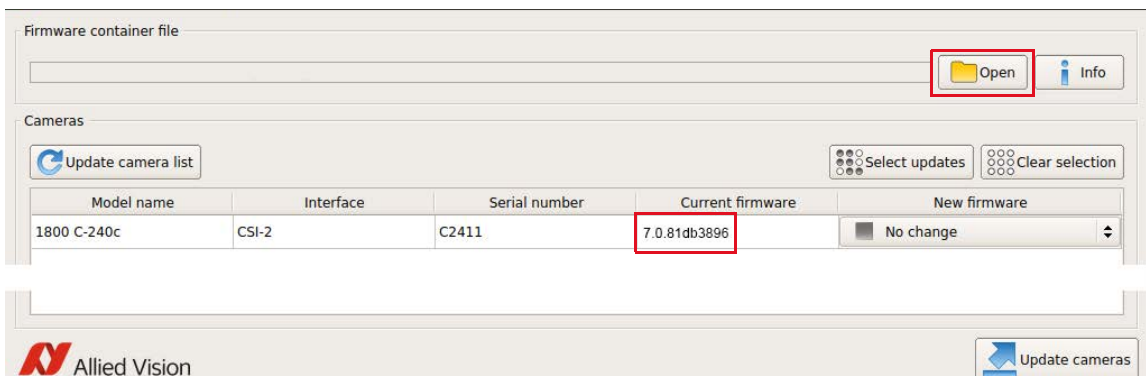

Figure 107: The camera and installed firmware are displayed

2. Select the firmware for the update from the drop-down menu.

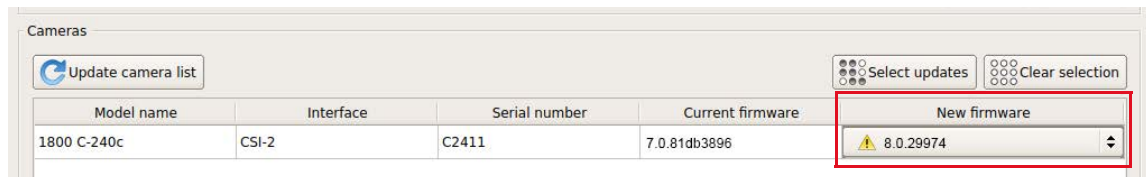

Figure 108: The firmware version is selected

3. Click **Update cameras**.

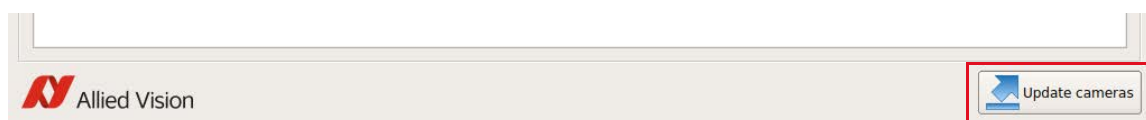

Figure 109: The update is being prepared

- Click **OK** to confirm.



Figure 110: The command to update the firmware is confirmed

The update progress is displayed.

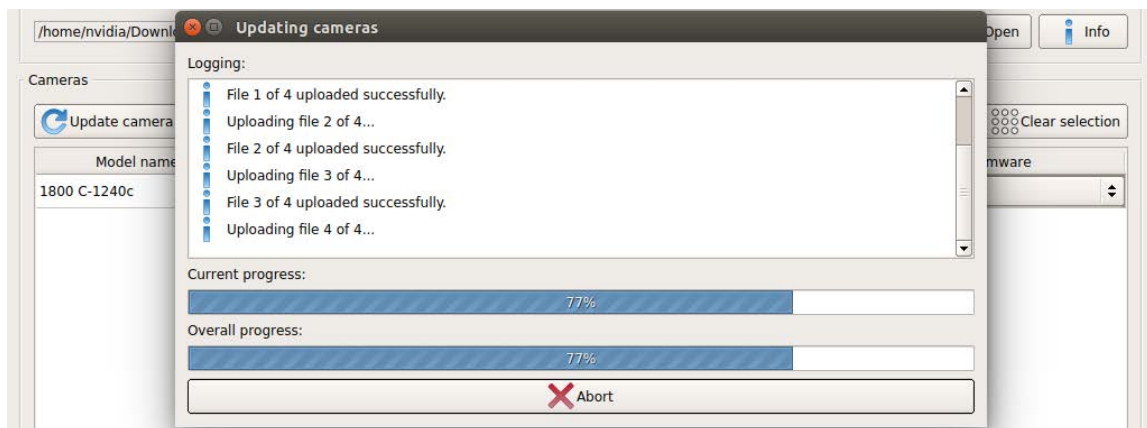

Figure 111: The update progress is displayed

- Click **Close** to confirm the completion of the update.

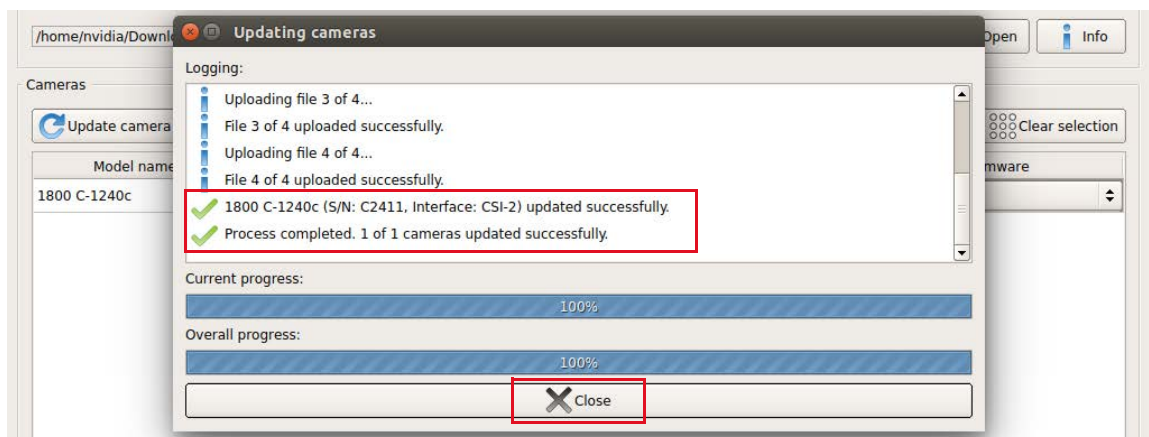

Figure 112: The update has been successfully completed

The camera is displayed with the updated firmware version.

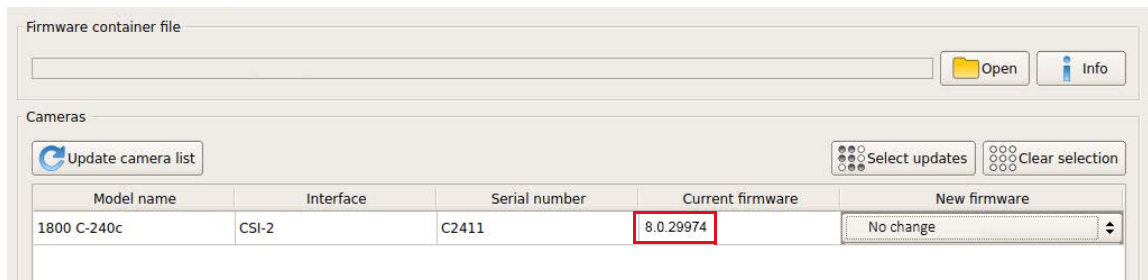

Figure 113: The updated firmware version is displayed

## Error handling

If firmware update fails,

- The camera is shown as “Fallback” on the CSI-2 interface.
- The camera is recognized by viewer applications but can not be used for streaming.
- You can repeat the firmware update.

Should the firmware update not succeed, please contact support at [www.alliedvision.com/en/about-us/contact-us/technical-support-repair-/-rma](http://www.alliedvision.com/en/about-us/contact-us/technical-support-repair-/-rma).

# Image data flow



This chapter includes:

Image data flow diagram .....	288
FPNC support .....	289

# Image data flow diagram

Figure 114 shows image data processing in Alvium CSI-2 cameras in general.

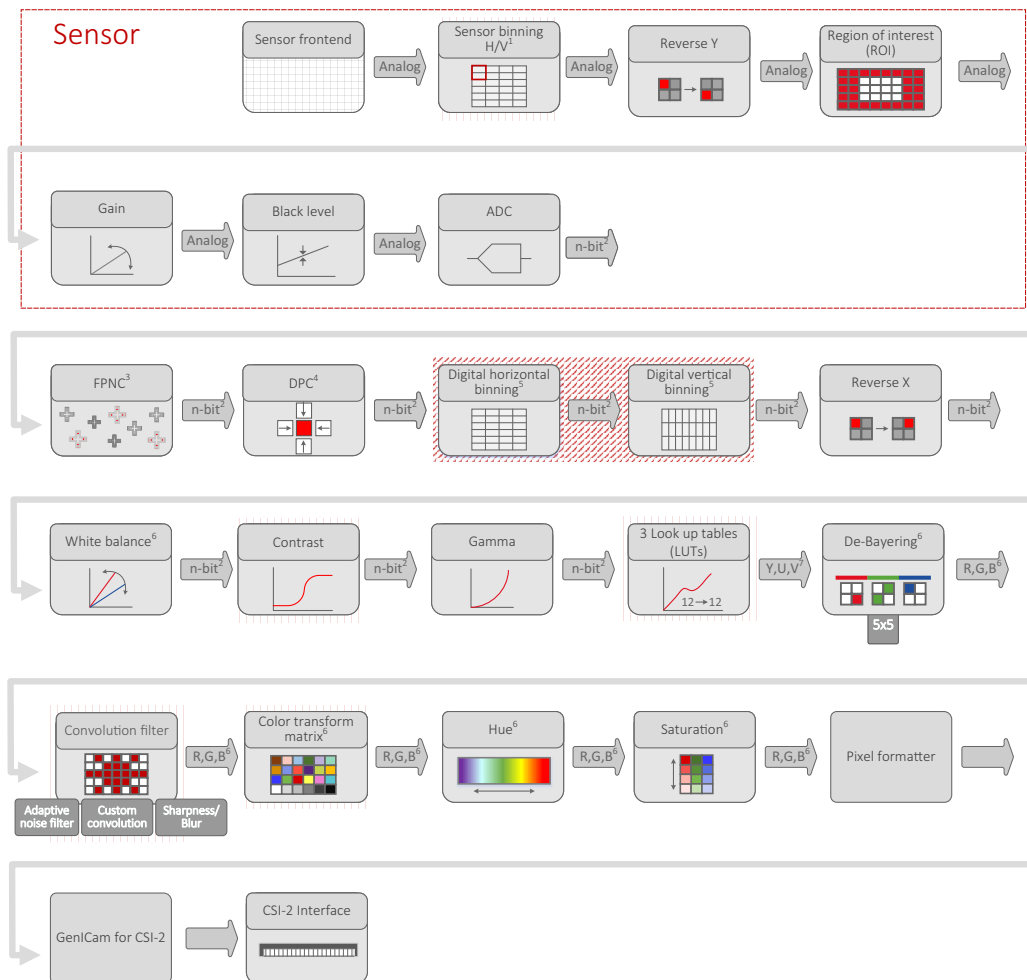

||| **GenICam for CSI-2 Access** only (all Alvium 1800 C models)

/// **GenICam for CSI-2 Access / Direct Register Access:** Different behavior

<sup>1</sup> Selected models only: See tables in [Specifications](#) on page 64

<sup>2</sup> Model dependent: See ADC bit depths in [Specifications](#) on page 64.

<sup>3</sup> Factory preset for FPNC = Fixed Pattern Noise Correction.  
See [FPNC support](#) on page 289 for supported models.

<sup>4</sup> Factory preset for DPC = Defect pixel correction

<sup>5</sup> For **Direct Register Access**: Values for H and V are commonly adjusted.

<sup>6</sup> Color models only

<sup>7</sup> For monochrome models: Y only

Figure 114: Image data flow of Alvium CSI-2 cameras





### Descriptions for controls and features

The shown functionalities represent controls or groups of controls:

- For V4L2 controls, see [www.linuxtv.org](http://www.linuxtv.org).
- For register controls, see the Alvium CSI-2 Register Controls Reference. See [www.alliedvision.com/en/support/technical-documentation/alvium-csi-2-documentation](http://www.alliedvision.com/en/support/technical-documentation/alvium-csi-2-documentation) for details.
- For GenICam features, see the Alvium Features Reference. See [www.alliedvision.com/en/support/technical-documentation/alvium-csi-2-documentation](http://www.alliedvision.com/en/support/technical-documentation/alvium-csi-2-documentation) for details.

## FPNC support

Table 147 shows which Alvium CSI-2 models support FPNC (Pixeled pattern noise correction):

Alvium model	Sensor	FPNC support	Alvium model	Sensor	FPNC support
X-030 VSWIR	IMX991	-	X-501 NIR	AR0522	✓
X-040	IMX287	✓	X-507	IMX264	✓
X-050	P480	✓	X-507 Pol	IMX264	-
X-052	IMX426	-	X-508	IMX250	✓
X-120	AR0135	✓	X-508 Pol	IMX250	-
X-130 VSWIR	IMX990	-	X-510	IMX548	✓
X-131	EV76C560	✓	X-511	IMX547	✓
X-158	IMX273	✓	X-530 VSWIR	IMX992	-
X-192	EV76C570	✓	X-811	IMX546	✓
X-203	IMX422	-	X-812 UV	IMX487	✓
X-210	AR0521	✓	X-895	IMX267	-
X-234	IMX249	-	X-1236	IMX304	✓
X-235	IMX174	-	X-1240	IMX226	✓
X-240	IMX392	✓	X-1242	IMX545	✓
X-291	IMX421	-	X-1620	IMX542	✓
X-319	IMX265	✓	X-2040	IMX541	✓
X-320 VSWIR	IMX993	-	X-2050	IMX183	-
X-500	AR0521	✓	X-2460	IMX540	✓

Table 147: FPNC availability by camera model

# Performance



This chapter includes:

Image transfer with rolling shutter cameras .....	291
Parameter changes .....	291
Value changes by control interdependencies.....	292
Dark current compensation .....	293
Shutter types affecting image readout .....	296

# Image transfer with rolling shutter cameras

Alvium X-210m/c, X-500m/c, X-501m/c NIR, X-1240m/c, and X-2050m/c

If acquisition is started and stopped in a short sequence, no image is transferred to the host. The duration cannot be predicted, because it depends on various factors.

## Parameter changes

Alvium X-210m/c, X-500m/c, X-501m/c NIR, X-1240m/c, and X-2050m/c

If parameters are changed while these cameras are streaming, the following effects can occur.

### Stopped streaming

When `AcquisitionMode` set to `MultiFrame`: If cameras are triggered by `AcquisitionStart`, the streaming stops when parameters are changed.

For `MultiFrame` acquisition, we recommend to you stop streaming before you change parameters.

### Frame rate jitter

Generally, some parameters can be changed during exposure without affecting the timing. For models with ON Semiconductor AR sensors and rolling shutter sensors, a different behavior must be considered for **camera operation in freerun mode without triggering**:

Changing parameters during exposure leads to frame rate jitter. When parameters are entered, the next frame starts only after readout and sensor reconfiguration delay are finished. When the camera is run in `ExposureAuto` mode, the actual frame rate is less than the calculated value for the corresponding exposure time. Consider frame rate jitter for your application, including a gap between `ExposureActive` signals.

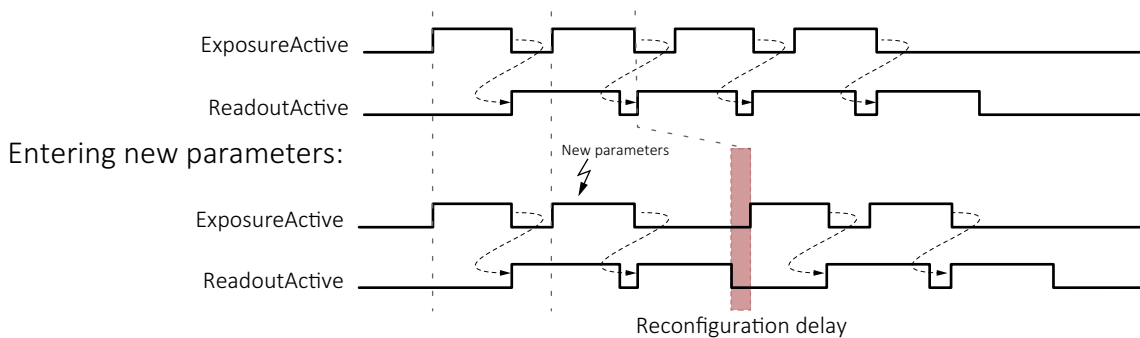

Figure 115: Delayed exposure due to parameter changes



**Parameter changes in triggered mode**

See [Ignored triggers](#) on page 281 for more information.

## Value changes by control interdependencies

The conversion between time and clock cycles affects control values. Controls for pixel format, bandwidth, ROI, and exposure time are related to each other. Changing values for one control can change values for another control. For example, frame rates can be reduced when MIPI Data Format is changed subsequently. [Figure 116](#) shows the interdependencies.

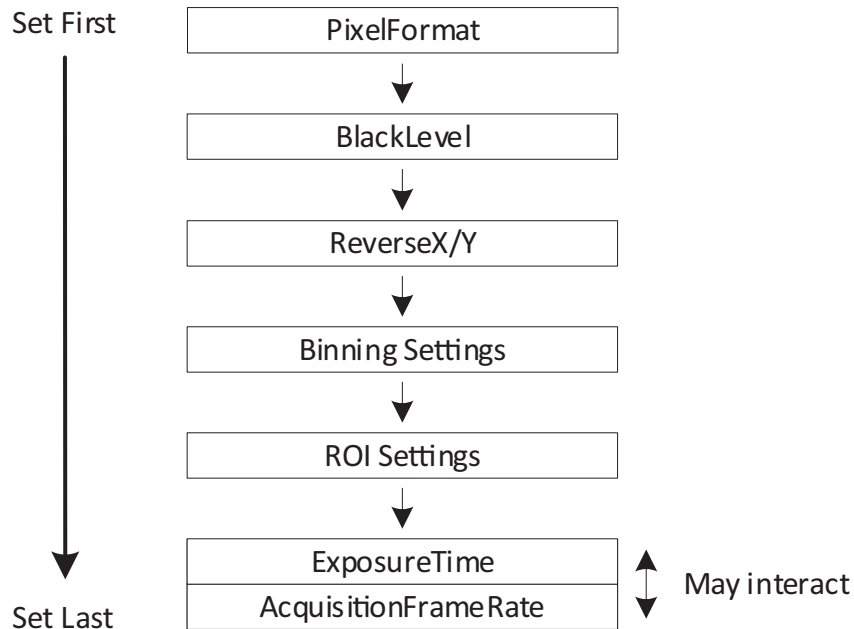

*Figure 116: Interdependencies between controls*

## Effects for the interdependent controls

Changing one control's value affects other control's values, such as:

If: **Height** value is changed.

Then: Other values may be affected, such as for **ExposureTime**.

We recommend you to consider:

- The more controls you adjust, the more current values deviate from previously set values.
- The same effects that apply to **ExposureTime**, also apply to **ExposureAuto**.
- To avoid readjustments, apply settings in the order shown in [Figure 116](#).

## Impact by other controls

Input	Output	
	Exposure time values	Frame rate
ExposureTime	Affected as expected	Affected
CSI-2LaneCount	Affected	Affected
Height	Not affected	Affected
Width	May be affected	May be affected

Table 148: Impact by other controls

### Exposure times and frame rates with Sony IMX rolling shutter cameras

Alvium 1800 C-1240 m/c and C-2050m/c

Generally, long exposure times result in low frame rates because one is roughly the inverse of the other. With Alvium IMX RS cameras

- The range of available frame rates depends on the exposure time.
- The exposure time must be increased when low frame rates are used.
- The available range for frame rate values depends on the exposure time. If by changing the exposure time, the previous frame rate is moved out of the available range, the frame rate is adjusted automatically.

## Dark current compensation

All sensors accumulate dark current in the pixels. Dark current increases the signal level and black level. Most sensors in Alvium CSI-2 cameras compensate for this.

For **Alvium 1500 C-050m/c** with the ON Semi PYTHON 480 sensor, see [Black level compensation for 1500 C-050m/c](#) on page 295.

If cameras are operated at high temperatures or exposure times, compensation reaches its limits. The typical compensation mechanism uses a **margin** to compensate for dark current. This works only until dark current reaches the size of the margin. The following table shows the relation of the margin and accumulated dark current for a pixel in 8-bit mode with a maximum value of 255.

Effective signal versus noise	Description
 <p>Saturation = 255</p> <p>Black level = 0</p>	<p>The pixel has accumulated no dark current, the margin has maximum size.</p>
 <p>Saturation = 255</p> <p>Black level = 0</p>	<p>The pixel has accumulated some dark current, reducing the size of the margin.</p>
<p>The following images show a pixel that has accumulated a higher dark current than the margin.</p>	
 <p>Saturation = 255</p> <p>Black level &gt; 0</p> <p>0</p>	<p>The pixel has accumulated dark current, the margin reduces to 0.</p> <p><b>Type 1 compensation</b></p> <ul style="list-style-type: none"> <li>• Dark current compensation is stopped.</li> <li>• Dark current increases the black level.</li> <li>• Fixed pattern noise increases.</li> </ul>
 <p>Saturation &lt; 255</p> <p>Black level = 0</p>	<p>The pixel has accumulated dark current, the margin reduces to 0.</p> <p><b>Type 2 compensation</b> (Typically used for sensor-internal compensation, often in the analog domain.)</p> <ul style="list-style-type: none"> <li>• Dark current compensation stays active.</li> <li>• Maximum saturation signal decreases.</li> <li>• Fixed pattern noise increases.</li> </ul>

Table 149: Accumulated dark current affecting the effective image signal

## Additional compensation

If compensation limits are reached and you cannot decrease operating temperature or exposure time, what can you do to keep signal quality high?

### Measures for type 1 compensation

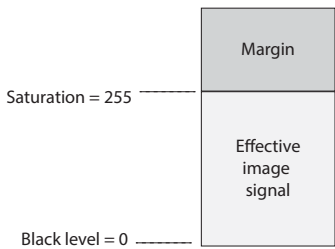
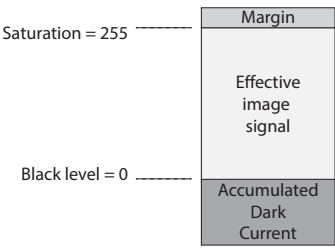
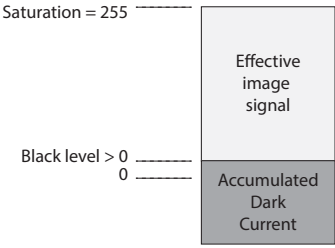
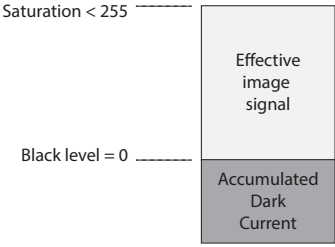
**Alvium 1500 C-050m/c** supports compensation type 1. For additional compensation, see [Black level compensation for 1500 C-050m/c](#) on page 295.

Typically, there is no measure to improve the image signal. The rising black level shifts black and dark gray values to gray.

### Measures for type 2 compensation

All other Alvium camera models support compensation type 2.

You can increase the margin size by using gain, with the following side effects:

- To give space to a larger margin, the effective pixel capacity decreases.
- White and light gray values are shifted down to gray.

## Black level compensation for 1500 C-050m/c



Because the ON Semi PYTHON 480 sensor does not have a dark current compensation, **Alvium 1500 C-050m/c** cameras have a typical black level value drift, depending on exposure time and **DeviceTemperature** (measured at the mainboard). [Table 150](#) shows the effect of the black level compensation. Should additional compensation be needed, we recommend cooling the camera.

Temperature [°C]	ExposureTime [ms]							
	1	10	50	100	250	500	750	1,000
35	Full	Full	Full	Full	Full	Full	Full	Full
40	Full	Full	Full	Full	Full	Full	Full	Full
45	Full	Full	Full	Full	Full	Full	Full	Full
50	Full	Full	Full	Full	Full	Full	Full	Full
55	Full	Full	Full	Full	Full	Full	Full	Full
60	Full	Full	Full	Full	Full	Partial	Partial	Partial
65	Full	Full	Full	Full	Partial	Partial	Partial	Partial
70	Full	Full	Full	Partial	Partial	Partial	Partial	Partial
75	Full	Full	Partial	Partial	Partial	Partial	Partial	Partial
Full compensation	Full compensation							
Partial compensation	Partial compensation							

Table 150: Exposure time and temperature affecting black level compensation

# Shutter types affecting image readout

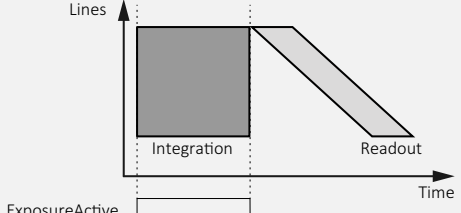
Most Alviium CSI-2 camera models are operated using global shutter (GS).

Property	Line readout	Moving image
Global shutter (GS)		

Alvium 1500 C-210, -500, and 1800 C-500 models use rolling shutter (RS).

Alvium 1800 C-1240 and -2050 models offer global reset shutter (GRS) in addition:



Property	Rolling shutter (RS)	Global reset shutter (GRS)
Line readout		
Line exposure start	Deferred from line to line	Common for all lines
Line exposure time	Common for all lines	Increases from line to line
Image acquisition of moving objects		
Image brightness	Constant over the image	Varying over the image
Moving objects	Distorted shape	Shape without distortion
Typical application	Static objects	Moving objects
Compensation	Use an additional mechanical shutter or	use a strobe light:
		

Table 151: Shutter types affecting image readout

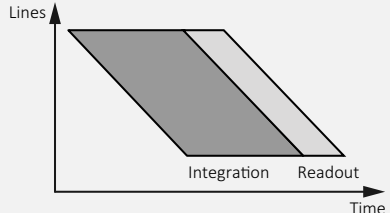
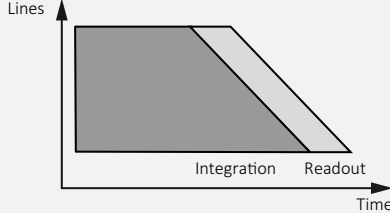

# Index

## A

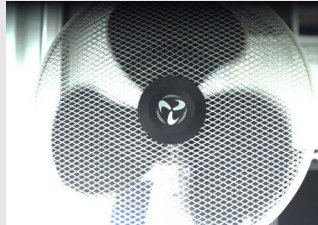
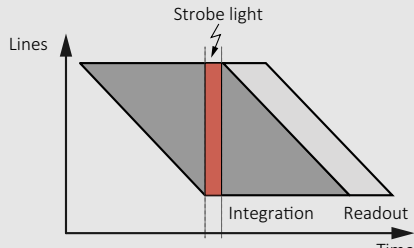
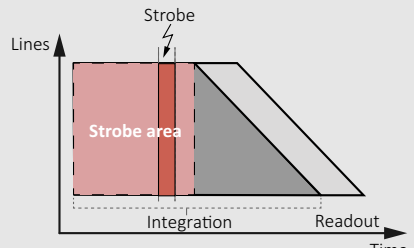
access modes .....	247
Allied Vision contact .....	23
Alvium Flex	
dimensions and mass .....	213
interface connection .....	270
overview .....	19
technical drawings .....	213
Alvium Frame	
aligning .....	260
camera mounting .....	261
dimensions and mass .....	218
overview .....	21
sensor position accuracy .....	223
technical drawings .....	218
Alvium Frame Flex	
dimensions and mass .....	219
technical drawings .....	219

## B

black level compensation .....	295
--------------------------------	-----

## C

camera identification	
model ID .....	52
serial numbers .....	253
CE .....	52
China RoHs .....	52
compliance .....	52
connectors .....	266
control interdependencies .....	292

## D

dark current compensation .....	293
digital binning .....	75
dimensions and mass	
Alvium Flex .....	213
Alvium Frame .....	218
Alvium Frame Flex .....	219
standard Alvium .....	207
Direct Register Access .....	247
document	
conventions .....	46
history .....	34

overview .....	15
terms .....	48
driver installation .....	252

## E

ESD .....	57
ExposureMode and exposure times .....	73

## F

feature availability .....	226
field of view	
vs. focal length .....	231
firmware update .....	282
flange focal distance .....	207
focal length	
vs. field of view .....	231
FPC connectors, pin assignment .....	268
frame rate	
jitter .....	291
reference settings .....	73
rolling shutter sensors .....	74
Sony IMX rolling shutter .....	293
frame rate jitter .....	291

## G

GenICam .....	65
GenICam features .....	249
GenICam for CSI-2 Access .....	247
global shutter (GS) .....	296
GPIOs	
input levels .....	275
output levels .....	275
ground .....	268
ground loops .....	58

## H

hardware assembly	
aligning Alvium Frame .....	260
camera mounting - Alvium Frame .....	261
camera mounting - bare board .....	257
camera mounting - open housed .....	258
FPC cable and FPC connectors .....	254
heat sink mounting .....	256
lens mounting .....	262
heat dissipation .....	55
Hirose F40C-50DP-0.4V description .....	270
Hirose FH55-22S-0.5SH description .....	268

I	
image data flow .....	288
image transfer with RS cameras .....	291
intended use .....	53
interfaces .....	266
IR cut filter .....	221
L	
lanes .....	268
LED .....	276
lenses .....	229
focal length vs. field of view .....	231
maximum protrusion .....	62
mounting .....	262
vignetting .....	230
M	
maximum protrusion	
safety .....	220
MIPI CSI-2 .....	65
N	
naming .....	48
P	
parameter changes	
frame rate jitter .....	291
stopped streaming .....	291
pin assignment .....	268
power consumption	
reference settings .....	75
Q	
quantum efficiency .....	68
R	
readout modes .....	72
register controls .....	249
rolling shutter (RS) .....	296
S	
safety .....	2, 8, 54
bare board cameras .....	60
camera power .....	58
electrical connections .....	57
embedded systems .....	56
FPC cables .....	59
ground loops .....	58
heat dissipation .....	55
heat sinks .....	62
Hirose FH55 and DF40C-50DP-0.4V .....	58
Hirose FH55 FPC connectors .....	59
lens mounts .....	54
maximum protrusion .....	62
optical components .....	60
PCBAs .....	57
sensor .....	61
sensor binning .....	75
sensor cleanliness (definition) .....	61
sensor handling .....	61
sensor position accuracy .....	222
shift and rotation with Alvium Frame ....	223
standard and Alvium Flex .....	222
SensorBitDepth .....	72
shock and vibration .....	65
S-Mount lenses	
focal length versus FOV .....	231
mounting .....	263
software installation .....	252
specifications .....	64
streaming is stopped .....	291
support .....	23
T	
technical drawings	
Alvium Flex .....	213
Alvium Frame .....	218
Alvium Frame Flex .....	219
standard Alvium .....	208
term definitions .....	48
triggering .....	277
troubleshooting .....	290
typical operation .....	75
U	
UART .....	273
user sets .....	225
V	
V4L2 controls .....	249
Video4Linux Access .....	247
W	
WEEE .....	52
white balance default .....	206