



GIGE VISION CAMERAS

Alvium G1 User Guide

This user guide applies to Alvium G1 cameras, and it is the basic reference for Alvium G1 OEM cameras. For individual information on Alvium G1 OEM cameras, please see the corresponding documents.

Note: Lenses are not part of this product.

V2.0.0

FW 00.13.01.794391f9

**Quick links**

- [Alvium G1 at a glance](#) on page 15
- [Contact us](#) on page 15
- [Contents](#) on page 16

Read before use

EN - English

Safety

Before using the product, read these safety instructions. Observe the warnings at all times. Use the camera only as stated in the [Intended use](#) on page 45.

**WARNING**

This product can expose you to chemicals including Carbon Black and Lead Acetate, which is known to the State of California to cause cancer. For more information go to: www.P65Warnings.ca.gov

**CAUTION****Risk of burns**

A camera in operation can reach temperature levels which could cause burns.

**CAUTION****Injury by falling cameras or lenses**

A falling camera or lens can cause injury.

**CAUTION****Risk of cuts by sharp edges**

The product can have sharp edges.

Intended use

Intended use of Allied Vision product is the integration into vision systems by professionals. All Allied Vision product is sold in a B2B setting.

DA - Dansk

Sikkerhed

Læs sikkerhedsanvisningerne, før kameraet bruges. Overhold alle advarsler. Brug kun kameraet som anført i [Intended use](#) på side 45.



FORSIGTIG

Forbrændingsfare

Når kameraet bruges, kan det blive meget varmt og forårsage forbrændinger.



FORSIGTIG

Kvæstelser, hvis kameraet eller linser falder ned

Falder kameraet eller linsen ned, kan dette forårsage kvæstelser.



FORSIGTIG

Fare for skarpe kanter

Produktet kan have skarpe kanter.

Tilsluttet brug

Allied Vision produktets tilsluttede brug er en indbygning i et visionssystem, udført af fagfolk. Alle Allied Vision produkter sælges i B2B.

DE - Deutsch

Sicherheit

Bevor Sie die Kamera benutzen, lesen Sie diese Sicherheitshinweise. Beachten Sie diese Hinweise immer. Verwenden Sie die Kamera nur wie beschrieben in [Intended use](#) auf Seite 45.



VORSICHT

Gefahr von Verbrennungen

Im Betrieb kann die Kamera Temperaturen erreichen, die zu Verbrennungen führen.



VORSICHT

Verletzung durch fallende Kameras oder Objektive

Eine fallende Kamera oder ein fallendes Objektiv kann Verletzungen verursachen.



VORSICHT

Schnitte durch scharfe Kanten

Das Produkt kann scharfe Kanten haben.

Bestimmungsgemäßer Gebrauch

Allied Vision Produkte sind bestimmt für die Integration in Bildverarbeitungssysteme durch Fachpersonal. Alle Allied Vision Produkte werden in einer B2B-Umgebung verkauft.

ES - Español

Seguridad

Antes de utilizar la cámara lea estas instrucciones de seguridad. Observe las advertencias en todo momento. Utilice la cámara solo tal y como se estipula en el [Intended use](#) en la página 45.



ADVERTENCIA

Este producto puede exponerle a sustancias químicas, como el carbono negro (Carbon Black) y acetato de plomo (Lead Acetate), que el Estado de California considera cancerígenas. Más información disponible en: www.P65Warnings.ca.gov



ATENCIÓN

Riesgo de quemaduras

Una cámara en funcionamiento puede alcanzar temperaturas que podrían provocar quemaduras.



ATENCIÓN

Lesiones en caso de que las cámaras o las lentes se caigan

Si una cámara o una lente se cae puede provocar lesiones.



ATENCIÓN

Riesgo de cortes por bordes afilados

El producto puede tener bordes afilados.

Uso previsto

El uso previsto del producto Allied Vision es la integración en el sistema de visión por parte de profesionales. Todos los productos Allied Vision se venden dentro de una relación B2B.

FI - Suomi

Turvallisuus

Lue nämä turvallisuusohjeet ennen kameran käyttöä. Noudata varoituksia joka hetki. Käytä kameraa ainoastaan kohdassa [Intended use](#) sivulla 45 kuvatulla tavalla.



HUOMIO

Palovammojen vaara

Käytössä olevan kameran saavuttamat lämpötilatasot voivat aiheuttaa palovammoja.



HUOMIO

Putoavien kameroiden tai linssien aiheuttamat vammat

Putoava kamera tai linssi voi aiheuttaa vammoja.



HUOMIO

Terävien reunojen aiheuttama viiltovaara

Tuotteessa voi olla teräviä reunoja.

Käyttötarkoitus

Allied Vision-tuotteen käyttötarkoitus on integrointi kuvajärjestelmiin ammattilaisten toimesta. Kaikki Allied Vision-tuotteet myydään B2B-ympäristössä.

FR - Français

Sécurité

Veillez lire ces consignes de sécurité avant d'utiliser la caméra. Respectez continuellement les avertissements. Utilisez la caméra uniquement comme indiqué sous [Intended use](#), page 45.



ATTENTION

Risque de brûlures

Une caméra en service peut atteindre des niveaux de température susceptibles d'entraîner des brûlures.



ATTENTION

Blessures en cas de chute de caméras ou d'objectifs

La chute d'une caméra ou d'un objectif peut entraîner des blessures.



ATTENTION

Risque de coupures sur des bords tranchants

Le produit peut présenter des bords tranchants.

Utilisation prévue

L'utilisation prévue du produit Allied Vision est son intégration dans des systèmes de vision par le soin de professionnels. Tout produit Allied Vision est vendu dans un cadre B2B.

עברית - HE

בטיחות

לפני השימוש במצלמה, עליך לקרוא את הוראות הביטחון האלו. עליך לממש הוראות ביטחון אלו תמיד. השימוש במצלמה הוא רק לפי מה שכתוב ב"כוונת השימוש" (Intended use) בעמוד 45.

זהירות

סכנת כווייה

בזמן הפערת המצלמה עלולות טמפרטורות גבוהות לעלות, שיכולות לגרום לכוויות.



זהירות

פגיעה מנפילת מצלמות או עדשות

מצלמה או עדשה שנופלות עלולות לגרום לפגיעה.



זהירות

סכנת חתכים על ידי קצוות חדים

למוצר יכולים להיות קצוות חדים..



שימוש מיועד

מוצרי AlliedVision מיועדים לשילוב במערכות ממוחשבת לעיבוד צילומים ע"י אנשי מקצוע. כל מוצרי AlliedVision נמכרים לשימוש בסביבת B2B.

IT - Italiano

Sicurezza

Leggere queste istruzioni per la sicurezza prima di utilizzare la telecamera. Osservare sempre tutte le avvertenze. Utilizzare la telecamera come descritto alla sezione [Intended use](#) a pagina 45.



ATTENZIONE

Pericolo di ustioni

Durante il funzionamento una telecamera può raggiungere temperature elevate che possono essere causa di ustioni.



ATTENZIONE

Lesioni dovute alla caduta di telecamere o lenti

La caduta di una telecamera o di una lente può causare delle lesioni.



ATTENZIONE

Pericolo di tagliarsi sui bordi affilati

I bordi del prodotto lente possono essere affilati.

Uso previsto

Il prodotto Allied Vision è concepito per essere integrato in sistemi di monitoraggio in campo professionale. Tutti i prodotti Allied Vision sono venduti in uno scenario B2B.

JA - 日本語

安全性

本カメラを使用する前に、この安全の手引きをお読みください。常に、警告事項を守ってください。必ず、[Intended use 45](#) ページの通りに、本カメラを使用してください。



注意

やけどの危険性

作動中のカメラは、やけどを引き起こす温度まで熱くなる恐れがあります。



注意

カメラまたはレンズの落下によるけが

カメラまたはレンズが落下すると、けがをする恐れがあります。



注意

な端部で切り傷の危険性

本製品には鋭利な部分がある場合があります。

用途

Allied Vision製品は、専門家が視覚装置に統合することを意図したものです。すべてのAllied Vision製品は、企業間取り引き用に販売されています。

NL - Nederlands

Veiligheid

Lees deze veiligheidsinstructies voordat u de camera gaat gebruiken. Neem deze waarschuwingen altijd in acht. Gebruik de camera uitsluitend, zoals aangegeven in het [Intended use](#) op pagina 45.



VOORZICHTIG

Risico van verbranding

Een camera die gebruikt wordt, kan temperatuurwaarden bereiken die brandwonden kunnen veroorzaken.



VOORZICHTIG

Letsel door vallende camera's of lenzen

Een vallende camera of lens kan letsel veroorzaken.



VOORZICHTIG

Risico van snijwonden door scherpe randen

Het product kan scherpe randen hebben.

Beoogd gebruik

Het beoogde gebruik van het Allied Vision-product is de integratie in optische systemen door professionals. Alle Allied Vision-producten worden verkocht in de B2B-markt.

NO - Norsk

Sikkerhet

Les disse sikkerhetsinstruksene før du bruker kameraet. Følg advarslene til en hver tid. Bruk kun kameraet i samsvar med [Intended use](#) på side 45.



FORSIKTIG

Risiko for brannskader

Et kamera i bruk kan nå temperaturnivåer som kan forårsake brannskader.



FORSIKTIG

Skade ved fallende kameraer eller linser

Et fallende kamera eller en fallende linse kan forårsake skade.



FORSIKTIG

Risiko for kutt fra skarpe kanter

Produktet kan ha skarpe kanter.

Tiltenkt bruk

Den tiltenkte bruken av Allied Vision-produktet er integrering i visjonssystemer av profesjonelle. Alle Allied Vision-produkter selges i en forretning til forretning-situasjon.

SV - Svenska

Säkerhet

Läs igenom säkerhetsinstruktionerna innan du använder kameran. Var hela tiden särskilt uppmärksam på varningarna. Använd enbart kameran på det sätt som anges i [Intended use](#) på sida 45.



VARNING

Risk för brännskada

En kamera i drift kan komma upp i temperaturer som kan orsaka brännskador.



VARNING

Risk för skador från fallande kameror eller objektiv

Fallande kameror eller objektiv kan förorsaka skador.



VARNING

Risk för skärsår från vassa kanter

Produkten kan ha vassa kanter.

Avsedd användning

Den avsedda användningen av Allied Vision-produkter är integrering i visionssystem av fackmän. Samtliga Allied Vision-produkter säljs i en B2B-miljö.

ZH - 简体中文版

安全需知

使用本相机前，请阅读本安全说明书。请务必遵守相关警告 和 [Intended use](#) 于第 45 页。



注意事项

烫伤风险

相机操作过程中温度可能上升并导致烫伤风险。



注意事项

相机或者镜头跌落造成伤害

相机或者镜头可能会跌落并造成伤害。



注意事项

镜锋利边缘割伤的风险

产品可能有锋利的边缘。

预期用途

Allied Vision 产品的预期用途是由专业人士整合到视觉系统中。所有 Allied Vision 的产品均通过 B2B 渠道销售。

Alvium G1 at a glance



Get an overview of Alvium G1 documentation:

Consider for Alvium G1 cameras	16
Shipping contents.....	16
What else do you need?	16
Alvium G1 BL (Board Level)- more flexibility	17
Alvium G1 BL Frame - use your own optical mount	18
Alvium Pol- using polarization (coming soon)	19

Consider for Alvium G1 cameras

For a smooth product experience, we suggest you to:

- Build up general knowledge: [Tips and tricks to connect 1000BASE-T](#) on page 238.
- Set up a quick running test: [Installing the camera](#) on page 188.
- Find solutions for issues: [Troubleshooting common issues](#) on page 254.
- Data for standard Alvium G1 Closed Housing cameras applies to Alvium G1 BL cameras as well, unless otherwise stated.

Shipping contents

- Alvium G1 camera
- Download Instructions for First Camera Operation document

What else do you need?

This is a selection of helpful downloads:

Download	Link
Alvium Cameras Features Reference	
Application notes	www.alliedvision.com/en/support/technical-documentation/alvium-gige-documentation
Alvium Modular Concept for extended hardware options, such as G1 BL	
Vimba X SDK for Windows, Linux, and Linux/ARM, including Vimba X Viewer , Driver Installer , and Firmware Updater	www.alliedvision.com/en/products/software/vimba-x-sdk
Firmware downloads	www.alliedvision.com/en/support/firmware-downloads
STEP files	Downloads for your Alvium G1 Closed Housing models: www.alliedvision.com/en/camera-selector Downloads for Alvium G1 BL (Board Level) or BL Frame: www.alliedvision.com/en/support/alvium-step-file-downloads
Assembling Alvium Cameras from CAD Component (application note)	www.alliedvision.com/en/support/technical-documentation/alvium-gige-documentation
Accessories , such as interface cables and cards, power and I/O cables, power supplies, lenses, and tripod and mounting adapters	www.alliedvision.com/en/products/accessories

Table 1: Downloads for Alvium G1 cameras

Alvium G1 BL (Board Level) - more flexibility

Hardware options for standard Alvium G1 Closed Housing cameras offer C-Mount, CS-Mount, and S-Mount. You want to change the position of the GigE and I/O connectors to expand the flexibility for your application? Or you want to mount Alvium G1 cameras in a housing with your own lens mount?

Alvium G1 BL (Board Level) cameras are available as

- **Alvium G1 BL C-Mount** (CS-Mount or S-Mount correspondingly)
- **Alvium G1 BL No Mount** (sensor unit without a housing)
- **Alvium G1 BL Frame**
(see [Alvium G1 BL Frame - use your own optical mount](#) on page 18).

See [Camera model naming](#) on page 38 for additional information.

The sensor unit connects to the interface unit through 110 mm or 200 mm FPC cables as shown in [Figure 1](#):

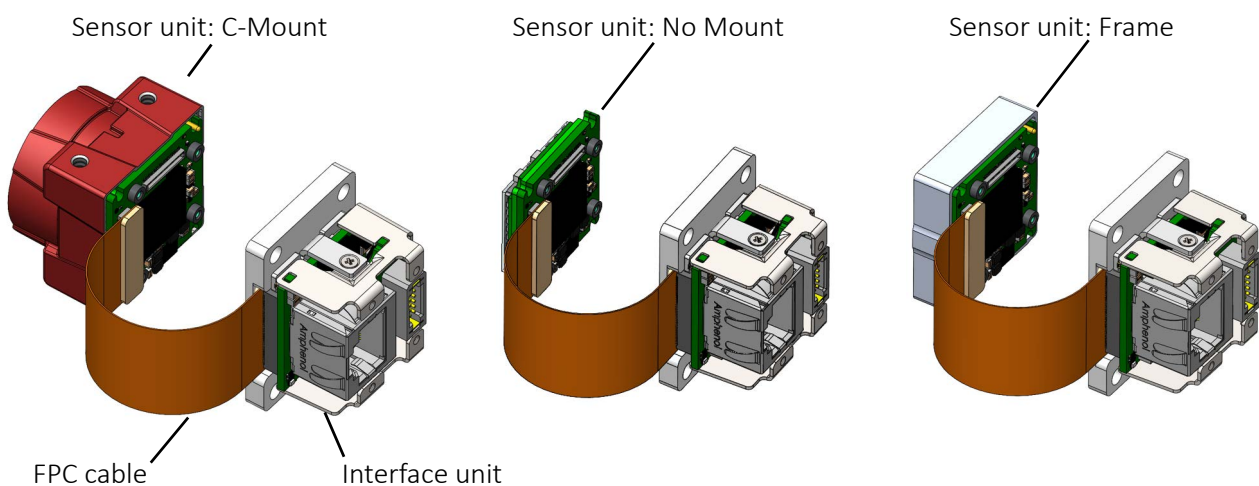

Figure 1: Alvium G1 BL hardware options and components

Contents in this user guide

- [Compliance, safety, and intended use](#) on page 41
- [Specifications](#) on page 54
- [Installing the camera](#) on page 188
- [Camera interfaces](#) on page 214.



Ordering Alvium G1 BL cameras

See the Alvium Modular Concept at www.alliedvision.com/en/support/technical-documentation/alvium-gige-documentation.

Alvium G1 BL Frame - use your own optical mount

You want to design your own lens mount for Alvium G1 cameras or your application does not need a lens mount? In this case, Alvium G1 BL Frame adds more flexibility. The square front flange with only 10.1 mm depth aligns to your individual housing with an extremely high accuracy.

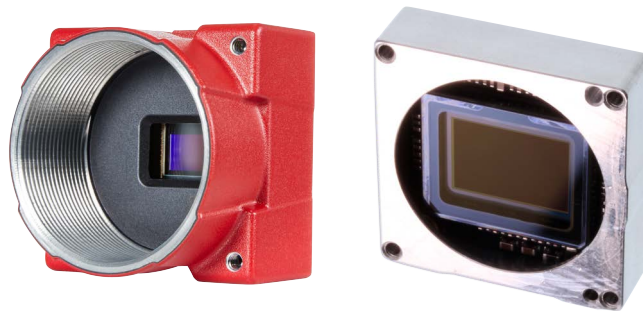

Figure 2: Alvium G1 BL sensor units > C-Mount (left), Frame (right)

Contents in this user guide

- [Compliance, safety, and intended use](#) on page 41
- [Specifications](#) on page 54
- [Mounting Alvium G1 BL Frame](#) on page 197
- [Camera interfaces](#) on page 214.



Alvium G1 BL overview

See [Alvium G1 BL \(Board Level\)- more flexibility](#) on page 17.



Ordering Alvium G1 BL Frame cameras

See the Alvium Modular Concept at www.alliedvision.com/en/support/technical-documentation/alvium-gige-documentation.

Alvium Pol - using polarization (coming soon)

Alvium polarizer cameras are equipped with Sony IMX Polarsens sensors that support four-directional polarization using filters directly in front of the sensor. With these cameras, you can replace additional polarizer filters on the lens used in typical applications. In many cases, polarizer sensors can adapt easily to setups with varying polarization angles; there is no need to change or rotate optical polarization filters anymore.

You can use polarized light imaging, for example, to reduce reflections or for surface analysis regarding stress and defects. [Figure 3](#) shows how the orientation of the polarization filters affects brightness values for the sub-images:



Figure 3: Polarization angle versus image brightness in sub-images

Current model: [Alvium G1-507m/c Pol \(coming soon\)](#) on page 108



Please observe

For first series models, pixel processing has not been adjusted to enable the complete functionality available with non-polarizer models:

- Only raw pixel formats are supported, but no formats for polarizer sensors.
- Features based on pixel processing are available but cannot be used to generate a proper output. For example, color processing, binning, convolution filter, DPC, or FPNC are not supported.



More information

See the Pixel based polarizer application note at www.alliedvision.com/en/support/technical-documentation/alvium-usb-documentation.

Contact us

Website, email

General

www.alliedvision.com/en/contact
info@alliedvision.com

Distribution partners

www.alliedvision.com/en/avt-locations/avt-distributors

Support

www.alliedvision.com/en/support
www.alliedvision.com/en/about-us/contact-us/technical-support-repair-/-rma

Offices

Europe, Middle East, and Africa (Headquarters)

Allied Vision Technologies GmbH
Taschenweg 2a
07646 Stadtroda, Germany
T// +49 36428 677-0 (Reception)
T// +49 36428 677-230 (Sales)
F// +49 36428 677-28

Asia-Pacific

China

Allied Vision Technologies
(Shanghai) Co., Ltd.
2-2109 Hongwell Int. Plaza
1602# ZhongShanXi Road
Shanghai 200235, China
T// +86 21 64861133

Singapore

Allied Vision Technologies Asia Pte. Ltd
82 Playfair Rd, #07-01 D'Lithium
Singapore 368001
T// +65 6634 9027

North, Central, and South America

Canada

Allied Vision Technologies Canada Inc.
300 – 4621 Canada Way
Burnaby, BC V5G 4X8, Canada
T// +1 604 875 8855

USA

Allied Vision Technologies, Inc.
102 Pickering Way- Suite 502
Exton, PA 19341, USA
Toll-free// +1-877-USA-1394
T// +1 978 225 2030

Contents

Read before use	2
EN - English	2
DA - Dansk	3
DE - Deutsch	4
ES - Español	5
FI - Suomi	6
FR - Français	7
HE - עברית	8
IT - Italiano	9
JA - 日本語	10
NL - Nederlands	11
NO - Norsk	12
SV - Svenska	13
ZH - 简体中文版	14
Alvium G1 at a glance	15
Consider for Alvium G1 cameras	16
Shipping contents	16
What else do you need?	16
Alvium G1 BL (Board Level) - more flexibility	17
Alvium G1 BL Frame - use your own optical mount	18
Alvium Pol - using polarization (coming soon)	19
Contact us	20
Document history and conventions	26
Document history	27
Conventions used in this user guide	36
Typographic styles	36
Symbols and notes	37
Camera model naming	38
Acronyms and terms	39
Compliance, safety, and intended use	41
Camera identification	42
Compliance notifications	42
For customers in the US	43
For customers in Canada	44
Pour utilisateurs au Canada	44
Alvium G1 BL cameras	44
Avoid electromagnetic interferences	44
Intended use	45
Copyright and trademarks	45
Your safety	45
Handling lens mounts and Alvium G1 BL Frame	45

Handling hot cameras	46
Providing optimum heat dissipation	46
Heat dissipation with Alvium G1 BL	46
Camera mounting	47
Product safety	48
Electrical connections	48
Optical components	51
Mechanical components	53
Specifications	54
Applied standards	55
GenICam	55
IP class	55
Shock and vibration	55
Notes on specifications	58
Sensor	58
Exposure time and frame rates	59
Triggering and sensor shutter types	61
Sensor shutter types	62
Brightness with G1-812 UV cameras	62
Digital binning	62
Sensor binning	62
Multiple regions	63
Operation for typical power consumption	65
Dimensions and mass	65
Alvium G1 model specifications	66
Alvium G1-030 VSWIR	66
Alvium G1-040m/c	70
Alvium G1-130 VSWIR	74
Alvium G1-131m/c (coming soon)	78
Alvium G1-158m/c	81
Alvium G1-192m/c (coming soon)	85
Alvium G1-234m/c	88
Alvium G1-240m/c	92
Alvium G1-319m/c	96
Alvium G1-500m/c	100
Alvium G1-507m/c	104
Alvium G1-507m/c Pol (coming soon)	108
Alvium G1-510m/c	111
Alvium G1-811m/c	115
Alvium G1-812 UV	119
Alvium G1-895m/c	123
Alvium G1-1236m/c	126
Alvium G1-1240m/c	130
Alvium G1-1242m/c	134
Alvium G1-1620m/c	138
Alvium G1-2040m/c	142
Alvium G1-2050m/c	146
Alvium G1-2460m/c	150

White balance default.	154
G1 Closed Housing: Dimensions and mass	155
G1 Closed Housing: Technical drawings	155
G1 Closed Housing C-Mount	156
G1 Closed Housing CS-Mount	157
G1 Closed Housing S-Mount	158
Alvium G1 BL: Dimensions and mass	159
G1 BL with mount	159
G1 BL Frame	159
G1 BL No Mount	159
Alvium G1 BL: Technical drawings	160
Alvium G1 BL C-Mount	160
Alvium G1 BL CS-Mount	161
Alvium G1 BL S-Mount	162
Alvium G1 BL Frame	163
Alvium G1 BL No Mount.	164
Alvium G1 BL interface unit	166
Lens mounts and maximum protrusion.	167
IR cut filter	168
Sensor position accuracy	169
Housed Alvium G1 cameras: Sensor shift and rotation.	169
Housed Alvium G1 BL Frame: Sensor shift and rotation	170
All housed Alvium G1 cameras: Sensor tilt.	170
User sets.	171
Supported features.	171
Trigger features and UserSetDefault.	172
Camera feature availability.	172
Lenses: Focal length vs. field of view	175
About this chapter.	176
Parameters in tables.	176
Optical vignetting with certain lenses	176
About S-Mount lenses.	177
Focal length versus field of view	177
Alvium G1-030 VSWIR	177
Alvium G1-040m/c	178
Alvium G1-130 VSWIR	178
Alvium G1-131m/c	179
Alvium G1-158m/c	179
Alvium G1-192m/c	180
Alvium G1-234m/c	180
Alvium G1-240m/c	181
Alvium G1-319m/c	181
Alvium G1-500m/c	182
Alvium G1-507m/c, -507 m/c Pol	182
Alvium G1-510m/c	183
Alvium G1-811m/c, -812 UV	183
Alvium G1-895m/c	184
Alvium G1-1236m/c	184

Alvium G1-1240m/c	185
Alvium G1-1242m/c	185
Alvium G1-1620m/c	186
Alvium G1-2040m/c	186
Alvium G1-2050m/c	187
Alvium G1-2460m/c	187
Installing the camera	188
Touching hot cameras.	189
Sensor damage by ESD	189
Alvium G1 BL No Mount cameras	189
Serial numbers of Alvium® chips of G1 BL No Mount and Frame cameras	190
Using heat sinks	191
Heat dissipation for all Alvium G1 cameras	191
Heat dissipation for Alvium G1 BL	192
Mounting Alvium G1 cameras	193
Instructions by Alvium G1 hardware option	193
Mounting G1 housed cameras	194
Mounting G1 BL cameras with mount	196
Mounting Alvium G1 BL Frame	197
Mounting G1 BL No Mount cameras	199
Mounting the G1 BL interface unit	201
Adapting maximum torque values	203
Mounting the lens	204
Mounting and focusing S-Mount lenses	205
Configuring the host computer	208
Installing the NIC driver	208
IP settings	209
Adjusting the NIC driver settings	210
Connecting the camera to the host	211
Configuring IP settings	211
Powering up the camera	212
Powering the camera via I/O port	212
Powering the camera via PoE	212
Software for your Alvium G1	213
Allied Vision software	213
Third-party software	213
Camera interfaces	214
I/Os: Precautions	215
Interface back panel	216
I/O connector pin assignment	217
I/Os and GPIOs	218
Isolated input description	218
I/O use for UART	218
Isolated output description	219
Non-isolated GPIOs description	221
G1 BL sensor unit back panel	223
Status LEDs	224

LED codes	224
Error state	224
Triggering and timings	225
Trigger signal flow	226
Trigger latency	226
Triggering with rolling shutter cameras	227
Ignored triggers	228
Trigger features and UserSetDefault	228
Image data flow	229
Image data flow diagram	230
FPNC support	231
Firmware update	232
Please note	233
Firmware update with Vimba X	233
Updating the firmware	234
Error handling	236
Performance and troubleshooting	237
Tips and tricks to connect 1000BASE-T	238
Hardware selection	238
NIC hardware installation	239
NIC firmware and drivers	239
NIC driver settings	239
Operation system settings	240
Vimba X TL settings	241
Optimizing performance	245
Image transfer with rolling shutter cameras	245
Parameter changes	245
Value changes by feature interdependencies	246
Dark current compensation	248
Shutter types affecting image readout	249
DevicePowerSavingMode	250
Operating systems and bandwidth	250
Reference system	252
Feature values	253
Troubleshooting common issues	254
Camera is not powered	254
Camera is not detected in the viewer	254
Camera cannot acquire images	255
Packets are dropped	256
Index	257

Document history and conventions



This chapter includes:

Document history	27
Conventions used in this user guide.....	36
Camera model naming.....	38
Acronyms and terms	39

Document history

Version	Date	Remarks
V2.0.0	2024-Mar-22	<p>Release: Firmware version: 00.13.01.794391f9</p> <ul style="list-style-type: none"> Added Available subregion resolutions on page 64. Added QE curve for Alvium G1-812 UV on page 119. Added DevicePowerSavingMode on page 250. Applied editorial changes.
V1.9.0	2024-Mar-05	<p>Firmware version: 00.13.00.71d891fe</p> <ul style="list-style-type: none"> Added note about documents for Alvium G1 OEM cameras on the title page. Added safety notes for handling sharp edges of Alvium Frame cameras in Read before use on page 2. Added introduction for Alvium Pol- using polarization (coming soon) on page 19. Added contents for Alvium G1 BL Frame in: <ul style="list-style-type: none"> - Alvium G1 at a glance on page 15 - Compliance, safety, and intended use on page 41 - Specifications on page 54 - Mounting Alvium G1 BL Frame on page 197. Added contents for manufacturing conditions regarding Sensor cleanliness on page 52. Added notes that bare board cameras must be aligned by the user in Specifications on page 54 and in Installing the camera on page 188. Added a note that the output bit depth affects the minimum available exposure times in Sensor ADC readout modes for maximum frame rates on page 60. Added contents for Sensor shutter types on page 62 and Brightness with G1-812 UV cameras on page 62. Updated exposure time ranges in Alvium G1 model specifications on page 66. <p>Continued on next page.</p>

Table 2: Document history

Version	Date	Remarks
V1.9.0	2024-Feb-15	<p>Continued from previous page.</p> <ul style="list-style-type: none"> • Added power consumption for G1-131 and -192 in Alvium G1 model specifications on page 66. • Changes to Specifications on page 54 and in Lenses: Focal length vs. field of view on page 175: <ul style="list-style-type: none"> - Added G1-507 Pol models (coming soon). - Aligned sensor size values to 1 decimal place • Updated contents in IP settings on page 209. • Added instructions for Configuring IP settings on page 211. • Added a note for Cognex VisionPro in Third-party software on page 213. • Extended the name of the camera's I/O connector from TFM-105-02-L-D to TFM-105-02-L-D-WT in Interface back panel on page 216. • Added information on FPNC support on page 231 and updated corresponding data in Camera feature availability on page 172. • Renamed chapter Frame rate jitter to Parameter changes on page 245 and added contents for stopped streaming. • Applied editorial changes.
V1.8.0	2023-Dec-04	<p>Release: Firmware version: 00.13.00.71d891fe</p> <ul style="list-style-type: none"> • Updated table for Frame rates with rolling shutter sensors on page 61. • Updated data in Alvium G1 model specifications on page 66: <ul style="list-style-type: none"> - Updated frame rates . - Changed width resolution for G1-510 from 2472 to 2464 pixels. (The width resolution for G1-510 is 2464 with all firmware versions. In earlier versions of this user guide, 2472 pixels were specified incorrectly.) - Separated Raw color pixel formats from RGB color pixel formats. - Added support for sensor binning for G1-158m and -240m models. • Updated Camera feature availability on page 172.

Table 2: Document history

Version	Date	Remarks
V1.7.0	2023-Oct-30	<p>Firmware version: 00.12.00.00611a22</p> <ul style="list-style-type: none"> Added data for the South Korean KC Safety Certification in Compliance notifications on page 42. Added contents to avoid possible damage to the sensor by ESD: <ul style="list-style-type: none"> Extended the note for ESD on page 48. Added a note in Possible damage to image sensors due to electrostatic charge on page 51 in the product safety chapter. Added a warning in Sensor damage by ESD on page 189 in the installation chapter. Added G1-131m/c and 192m/c models (both are coming soon) in Specifications on page 54 and in Lenses: Focal length vs. field of view on page 175. In order to avoid misunderstandings, truncated the name of the camera's I/O connector to TFM-105-02-L-D in Interface back panel on page 216. Applied editorial changes.
V1.6.0	2023-Sep-18	<p>Firmware version: 00.12.00.00611a22</p> <ul style="list-style-type: none"> Added contents for Alvium G1 BL (Board Level) in: <ul style="list-style-type: none"> Alvium G1 at a glance on page 15, Camera model naming on page 38, Acronyms and terms on page 39, Compliance, safety, and intended use on page 41, Technical data and drawings in Specifications on page 54, Notes and instructions in Installing the camera on page 188, Camera interfaces on page 214. Added notes against using external power and PoE at the same time in Product safety on page 48, Powering up the camera on page 212. Applied editorial changes.
V1.5.4	2023-Aug-10	<p>Firmware version: 00.12.00.00611a22</p> <p>Increased mass by 5 g in G1 Closed Housing: Dimensions and mass on page 155 to include thermal compound.</p>

Table 2: Document history

Version	Date	Remarks
V1.5.3	2023-Jul-12	Firmware version: 00.12.00.00611a22 <ul style="list-style-type: none"> Added safety notes for Proposition 65 by the State of California in Read before use on page 2. For all models, increased the maximum housing temperature for operation to 65 °C in Alvium G1 model specifications on page 66. Added Global reset shutter (GRS) as shutter type for Alvium G1-2050m/c on page 146.
V1.5.2	2023-Jul-05	Firmware version: 00.12.00.00611a22 Changed horizontal resolution for G1-510 in Alvium G1 model specifications on page 66.
V1.5.1	2023-Jun-15	Firmware version: 00.12.00.00611a22 Updated compliance with GigE Vision standard to V2.2 in Applied standards on page 55.
V1.5.0	2023-Jun-14	Firmware version: 00.12.00.00611a22 <ul style="list-style-type: none"> Added 12-bit pixel formats in Alvium G1 model specifications on page 66. Added G1-895m/c models in Specifications on page 54 and in Lenses: Focal length vs. field of view on page 175. Completed contents in Camera feature availability on page 172. Applied editorial changes.

Table 2: Document history

Version	Date	Remarks
V1.4.0	2023-Jun-06	<p>Release: Firmware version: 00.12.00.00611a22</p> <ul style="list-style-type: none"> • Updated Hebrew contents in Read before use on page 2. • Updated contents in Operation for typical power consumption on page 65. • Updates data in Alvium G1 model specifications on page 66: <ul style="list-style-type: none"> - Added data on multiple regions and sensor binning for selected models. - Changed minimum operating temperature value for Mainboard from +5 °C to -20 °C. - Updated QE curves for G1-030 VSWIR and G1-130 VSWIR. • Updated maximum resolution values and the according frame rates for Alvium G1-1620m/c on page 138 to 5328 (H) × 3040 (V). • Reduced value for sensor shift with G1-2050 models to 150 µm in Sensor position accuracy on page 169. • Added multiple regions and sensor binning to Camera feature availability on page 172. • Corrected data in table for I/O use for UART on page 218. • Added multiple regions and sensor binning to Image data flow on page 229. • Updated contents in Firmware update on page 232. • Updated contents for Intel I219LM chipset in Hardware selection on page 238. • Updated contents for Vimba X. • Applied editorial changes.

Table 2: Document history

Version	Date	Remarks
V1.3.0	2023-Jan-09	Firmware version: 00.11.00.9cf0c21e <ul style="list-style-type: none"> Added G1-030 VSWIR, G1-130 VSWIR, G1-812 UV, and G1-1240m/c models in Specifications on page 54 and in Lenses: Focal length vs. field of view on page 175. Corrected the width value in the specifications for Alvium G1-1620m/c on page 138. Added values for minimum bandwidth to reach maximum frame rates in Alvium G1 model specifications on page 66. Correct contents in Operating systems and bandwidth on page 250. Applied editorial changes.
V1.2.2	2022-Nov-14	Firmware version: 00.11.00.9cf0c21e <ul style="list-style-type: none"> Updated the title image. Added note that lenses are not part of the product. Updated values for the operating temperature range of Alvium G1-510m/c on page 111.

Table 2: Document history

Version	Date	Remarks
V1.2.1	2022-Oct-27	<p>Release: Firmware version: 00.11.00.9cf0c21e</p> <ul style="list-style-type: none"> • Updated standard references in Applied standards on page 55. • Added note on deviations from stated frame rates in Operation for maximum frame rates on page 59. • Replaced previous calculated values for ROI frame rates by measured values in Alvium G1 model specifications on page 66. • Changed maximum gain of Sony IMX global shutter cameras in Alvium G1 model specifications on page 66 from 24 dB to 48 dB. • Changed status for Alvium G1-510 models in Alvium G1 model specifications on page 66 to available. • Changes to Camera feature availability on page 172: <ul style="list-style-type: none"> - Added Burst Mode for image acquisition - Removed Image Chunk Data. - Added Sequencer. - Added Burst Mode for image acquisition. - Removed Image Chunk Data. - Added Sequencer. • Added contents for Ethernet Flow Control to avoid dropped frames in NIC driver settings on page 239. • Added Reference system on page 252 for measurements of ROI frame rates. • Applied editorial changes.

Table 2: Document history

Version	Date	Remarks
V1.2.0	2022-Sep-19	Firmware version: 00.10.00.2cf3b22e <ul style="list-style-type: none"> Added Hebrew contents to Read before use on page 2. Changed units KB to KByte, MB to MByte, and MBps to MByte/s for clarity. Updated notes for PoE power in Product safety on page 48, Powering up the camera on page 212, and I/Os: Precautions on page 215. Updated data in Alvium G1 model specifications on page 66: <ul style="list-style-type: none"> Changed status for Alvium G1-234 models to available and adjusted pixel formats. Added values for the power consumption and ROI frame rates for Alvium G1-510 models. Added Alvium G1-1240 models to Alvium G1 model specifications on page 66 and Lenses: Focal length vs. field of view on page 175.
V1.1.2	2022-Aug-08	Firmware version: 00.10.00.2cf3b22e <ul style="list-style-type: none"> Removed data for Alvium G1-235 models from Specifications on page 54 and Lenses: Focal length vs. field of view on page 175. Reverted change for the maximum gain of Sony IMX global shutter cameras in Alvium G1 model specifications on page 66 from 48 dB back to 24 dB.
V1.1.1	2022-Jul-22	Firmware version: 00.10.00.2cf3b22e <p>Added values for minimum and maximum exposure times in Alvium G1 model specifications on page 66.</p>

Table 2: Document history

Version	Date	Remarks
V1.1.0	2022-Jul-20	<p>Release: Firmware version: 00.10.00.2cf3b22e</p> <ul style="list-style-type: none"> Replaced notes to inquire with Allied Vision Sales representatives by download links to the Allied Vision website. Removed notes for early production cameras from Consider for Alvium G1 cameras on page 16. Added G1-235m/c model in Specifications on page 54 and in Lenses: Focal length vs. field of view on page 175. Updated data in Alvium G1 model specifications on page 66: <ul style="list-style-type: none"> Values for operating temperature ROI frame rates and exposure time ranges Maximum gain for Sony IMX global shutter cameras increased to 48 dB. Added new functionalities to Camera feature availability on page 172. Added I/O use for UART on page 218. Added support for DPC and FPNC in Image data flow on page 229. Removed the sections “Feature validation status” and “Feature value changes on a streaming camera” from Performance and troubleshooting on page 237. Applied editorial changes.
V1.0.4	2022-Jun-08	<p>Firmware version: 00.09.00.e23cb4e8</p> <ul style="list-style-type: none"> Added Camera identification on page 42, including Model ID for DoC assignment. Replaced calculated values for power consumption in Alvium G1 model specifications on page 66 by measured values. Updated data for Alvium G1-234m/c in Alvium G1 model specifications on page 66. Added warning against voltage levels of serial communication and wrong polarity of external power in I/Os: Precautions on page 215. Applied editorial changes.

Table 2: Document history

Version	Date	Remarks
V1.0.3	2022-May-19	Firmware version: 00.09.00.e23cb4e8 <ul style="list-style-type: none"> Rounded values in G1 Closed Housing: Dimensions and mass on page 155 from 62 g to 65 g in order to match conventions for Alvium cameras. Adapted descriptions in Table 110: TFM I/O connector pin assignment on page 217 to ease the comparison with previous Allied Vision GigE cameras. Applied editorial changes.
V1.0.2	2022-May-09	Firmware version: 00.09.00.e23cb4e8 Added advice in ESD on page 48.
V1.0.1	2022-Apr-28	Firmware version: 00.09.00.e23cb4e8 <ul style="list-style-type: none"> Reversed maximum operation temperature in Alvium G1 model specifications on page 66 from concreted values to “tbd”. Added notes against material damage for GPIOs with PoE power in I/Os and GPIOs on page 218. Added Tips and tricks to connect 1000BASE-T on page 238. Applied editorial changes.
V1.0.0	2022-Apr-12	Release: Firmware version: 00.09.00.e23cb4e8 Release version

Table 2: Document history

Conventions used in this user guide

To give this manual an easily understood layout and to emphasize important information, the following typographical styles and symbols are used.

Typographic styles

Style (example)	Function
Emphasis	Programs, or highlighting important things
Feature names	GenICam features names
<i>Feature options</i>	Features options and register’s options that are selectable by the user

Table 3: Typographic styles (sheet 1 of 2)

Style (example)	Function
UI Element	Text that is displayed, or output, by the system for the user, like parts of the GUI, dialog boxes, buttons, menus, important information, windows titles.
Reference	Links to webpages and internal cross references

Table 3: Typographic styles (sheet 2 of 2)

Symbols and notes



Warning

Risk is described



CAUTION

Risk of burns

Precautions are described



CAUTION

Injury by falling cameras or lenses

Precautions are described



CAUTION

Risk of cuts by sharp edges

Precautions are described



NOTICE

Material damage or violation of data security

Precautions are described.



Practical Tip

Additional information helps to understand or ease handling the camera.



Avoiding malfunctions

Precautions are described.

Additional information

Web link or reference to an external source with more information is shown.

Camera model naming

Alvium cameras are named to identify model properties.

Standard **Alvium G1-500c Closed Housing C-Mount** model:

	Alvium	G1	500	c	Closed Housing	C-Mount
Content element	Camera series	Interface	Resolution ¹	Chroma	Hardware option	Lens mount
Examples	Alvium	G1: GigE	500: 5.0 MP 811: 8.1 MP	c: color m: monochrome	Closed Housing BL: Board Level	C-Mount No Mount

¹Model resolutions may slightly deviate from model naming.

Table 4: Camera model naming for a standard G1 Closed Housing camera

Alvium G1-500c BL C-Mount model with extended hardware options:

	Alvium	G1	500	c	BL	C-Mount
Content element	Camera series	Interface	Resolution ¹	Chroma	Hardware option	Lens mount
Examples	Alvium	G1: GigE	500: 5.0 MP 811: 8.1 MP	c: color m: monochrome	Closed Housing BL: Board Level	C-Mount Frame

¹Model resolutions may slightly deviate from model naming.

Table 5: Camera model naming for a G1 BL camera

Ordering Alvium G1 BL cameras

See the Alvium Modular Concept at www.alliedvision.com/en/support/technical-documentation/alvium-gige-documentation.

Acronyms and terms

The following table provides a list of acronyms and terms used in this document.

Acronym or term	Description
ADC	Analog to digital converter
AIA	Automated Imaging Association
BL	Board Level Alvium G1 BL hardware options use this acronym.
board level camera	Camera consisting of the sensor unit connected by the FPC cable to the interface unit
Closed Housing	Hardware used with standard Alvium G1 cameras
CRA	Chief ray angle
EMVA	European Machine Vision Association
ERS	Electronic rolling shutter also known as “rolling shutter”
ESD	Electrostatic discharge
FCC	Federal Communications Commission
FOV	Field of view
FPC cable	Flat printed circuit cable, used to connect the sensor unit to the interface unit of Alvium G1 BL cameras
FPNC	Pixed pattern noise correction
fps	Frames per second
GenICam	Generic Interface for Cameras, EMVA
GND	Ground (power)
GPIOs	General purpose inputs and outputs (non-isolated)
GRRS	Global reset release shutter, see GRS
GRS	Global reset shutter, see GRRS
GS	Global shutter
H × V	Horizontal × vertical (sensor resolution)
interface unit	Component of an Alvium G1 BL camera including the RJ 45 connector for GigE and the TFM I/O connector
KByte	Kilobyte
MByte	Megabyte
MByte/s	Megabyte per second
MP	Megapixels (see P)
N.a.	Not applicable (in tables)
NIC	Network interface card

Table 6: Acronyms and terms (sheet 1 of 2)

Acronym or term	Description
No Mount	Variant of Alvium G1 BL cameras using a sensor unit without a housing
P	Pixels (see MP)
PSE	Power sourcing equipment
QE	Quantum efficiency
RoHS	Restriction of Hazardous Substances Directive
ROI	Region of interest
RS	Rolling shutter
sensor unit	Component of an Alvium G1 BL camera including the sensor and the electronics
SFNC	Standard Feature Naming Convention (GenICam)
shutter mode	Value of the ShutterMode feature to select between rolling shutter (RS) and global release shutter (GRS)
shutter type	Sensor specific readout, such as rolling shutter (RS) or global shutter (GS)
S-Mount	M12-Mount

Table 6: Acronyms and terms (sheet 2 of 2)

Compliance, safety, and intended use



This chapter includes:

Camera identification.....	42
Compliance notifications	42
Intended use	45
Copyright and trademarks	45
Your safety.....	45
Product safety	48

Camera identification

You can identify your Alvium G1 camera like this:

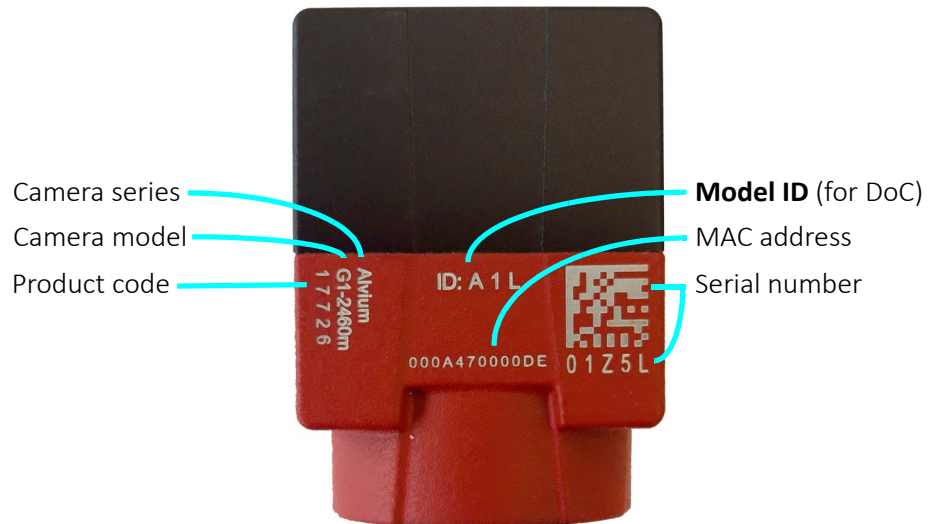

Hardware option	Model ID
Alvium G1 Closed Housing C-Mount / CS-Mount / S-Mount	A 1 L
Alvium G1 BL C-Mount / CS-Mount / S-Mount	A 1 T
Alvium G1 BL Frame	A 1 S

Table 7: Hardware options and model IDs

The variants of Alvium G1 Closed Housing cameras (model ID: A 1 L) are **KC certified**. Alvium G1 BL (Board Level) cameras with C-Mount / CS-Mount / S-Mount (A 1 T), with Frame (A 1 S), and G1 BL without mount are unfinished devices that require housing by the customer for EMC compliance and hence cannot be KC certified.

Compliance notifications



National regulations on disposal must be followed.



For customers in the US

Closed Housing cameras only: FCC Class B digital device

This equipment has been tested and found to comply with the limits for a Class B digital device, pursuant to part 15 of the FCC Rules. These limits are designed to provide reasonable protection against harmful interference in a residential installation. This equipment generates, uses and can radiate radio frequency energy and, if not installed and used in accordance with the instructions, may cause harmful interference to radio communications. However, there is no guarantee that interference will not occur in a particular installation. If this equipment does cause harmful interference to radio or television reception, which can be determined by turning the equipment off and on, the user is encouraged to try to correct the interference by one or more of the following measures:

- Reorient or relocate the receiving antenna.
- Increase the separation between the equipment and receiver.
- Connect the equipment into an outlet on a circuit different from that to which the receiver is connected.
- Consult the dealer or an experienced radio/TV technician for help.

Supplier Declaration of Conformity

Alvium G1 cameras comply with Part 15 of the FCC Rules. Operation is subject to the following two conditions:

1. This device may not cause harmful interference, and
2. This device must accept any interference received, including interference that may cause undesired operation.

Party issuing Supplier's Declaration of Conformity

Allied Vision Technologies GmbH
Taschenweg 2a
07646 Stadtroda, Germany
T// +49 (36428) 677-106
quality@alliedvision.com

Responsible party - US contact information

Allied Vision Technologies, Inc.
102 Pickering Way – Suite 502
Exton, PA 19341, USA
T// +1 978 225 2030

Note: changes or modifications not expressly approved by the party responsible for compliance could void the user's authority to operate the equipment.

For customers in Canada

Closed Housing cameras only

This apparatus complies with the Class B limits for radio noise emissions set out in the Radio Interference Regulations.

CAN ICES-3 (B) / NMB-3 (B)

Pour utilisateurs au Canada

Boîtier de caméra fermé (Closed Housing) seulement

Cet appareil est conforme aux normes classe B pour bruits radioélectriques, spécifiées dans le Règlement sur le brouillage radioélectrique.

CAN ICES-3 (B) / NMB-3 (B)

Alvium G1 BL cameras

Alvium G1 BL cameras are unfinished devices that are not EMC compliant in themselves. To meet EMC requirements, they must be appropriately housed in the customer's device and under the customer's responsibility.



Requirements for EMC housings

For initial guidance on electromagnetic compatibility, see the Electromagnetic Compatibility for Open Housing Alvium Cameras application note at www.alliedvision.com/en/support/technical-documentation/alvium-gige-documentation.

Avoid electromagnetic interferences

Interface cables, power cables, and I/O cables are sensitive to electromagnetic interference.

- Use shielded cables only.
- We recommend using cables offered by Allied Vision.
- Avoid coiling.
- We recommend using GPIOs only in environments with low electromagnetic interference.

Moreover, avoid unnecessary bending to prevent damage to the cables.

Intended use

Allied Vision's objective is the development, design, production, maintenance, servicing and distribution of digital cameras and components for image processing. We are offering standard products as well as customized solutions.

Intended use of Allied Vision product is the integration into Vision systems by professionals. All Allied Vision product is sold in a B2B setting.

Allied Vision isn't a legal manufacturer of medical product. Instead, Allied Vision cameras and accessories may be used as components for medical product after design-in by the medical device manufacturer and based on a quality assurance agreement (QAA) between Allied Vision (supplier) and medical device manufacturer (customer). Allied Vision's duties in that respect are defined by ISO 13485, clause 7.2 (customer-related processes, equivalent to ISO 9001, clause 8.2).

Copyright and trademarks

All text, pictures, and graphics are protected by copyright and other laws protecting intellectual property. All content is subject to change without notice.

All trademarks, logos, and brands cited in this document are property and/or copyright material of their respective owners. Use of these trademarks, logos, and brands does not imply endorsement.

Copyright © 2024 Allied Vision GmbH. All rights reserved.

Your safety

This section informs about issues related to your personal safety. Descriptions explain how to avoid hazards and operate Alvium G1 cameras safely.

Handling lens mounts and Alvium G1 BL Frame

The lens mount thread can have sharp edges. Be careful these edges do not cut your skin when mounting or unmounting lenses.

The circular front opening of Alvium G1 BL Frame cameras has sharp edges.

- Avoid touching these edges with your fingers.
- Wear protective gloves for handling Alvium Frame cameras with an open circular front opening.

Follow the instructions in [Mounting Alvium G1 BL Frame](#) on page 197.

Handling hot cameras

Depending on the individual setup, Alvium G1 cameras can exceed the specified maximum operating temperature. In many cases, mounting the camera on a metal surface or using a lens will be sufficient to cool the camera effectively. However, especially when operated in higher ambient temperatures, additional measures for heat dissipation, such as using a heat sink, should be considered.

If you have doubts or questions, please feel free to contact your Allied Vision Sales representative for support!

If the mainboard temperature exceeds the specified maximum for more than two seconds, the camera is powered off automatically. The current value for mainboard temperature is output by **DeviceTemperature**. You can use this value to control cooling by software, for example, to control a fan.

However, if you hold the camera in your hands during operation, your skin may get hurt. If you touch the camera when it is heated up, we recommend wearing protective gloves.

Providing optimum heat dissipation

Keep the operating temperature in the specified range to enable best image quality and to protect the camera from damage.

For your safety and to improve image quality, we recommend operating the camera, **including the G1 BL interface unit**:

- Mounted to a base with a high thermal conductivity
- With lens or other optical components mounted
- With a heat sink mounted that has large surface areas
- Using conductive media for camera and heat sink mounting
- With active cooling of the camera, mounting base, and heat sink, such as by ventilation.
- Reduce high ambient temperature. For example, in outdoor applications with direct sunlight, provide shading by an enclosure.

Heat dissipation with Alvium G1 BL

In addition to the instructions in [Providing optimum heat dissipation](#) on page 46, observe the following:

Design Alvium G1 BL and G1 BL Frame cameras into a heat dissipative housing with a high thermal conductivity. See also [Cooling area for the Alvium G1 BL sensor unit](#) on page 192 and [Mounting the G1 BL interface unit](#) on page 201.

Keep the operating temperature in the specified range to enable best image quality and to protect the camera from damage. Temperature values apply to a relative humidity of 0 to 80 percent that is non-condensing.

Hardware option	Housing	Components in the cooling area ¹	Mainboard ²
Without mount ³	Not applicable	-20 °C to +85 °C	See model Specifications on page 64.
With mount ⁴	-20 °C to +65 °C		

¹See [Heat dissipation for Alvium G1 BL](#) on page 192.

²Output by `DeviceTemperature`, using Direct Register Access.

³Ensure that the sensor is operated in the temperature range specified by the manufacturer. For any questions, please visit www.alliedvision.com/en/support.

⁴Temperature values must be observed for the housing **and** for the cooling area.

Table 8: Operating temperature ranges for Alvium G1 BL cameras

Observe that not only the sensor unit must be cooled, but also the interface unit as shown in [Figure 4](#).

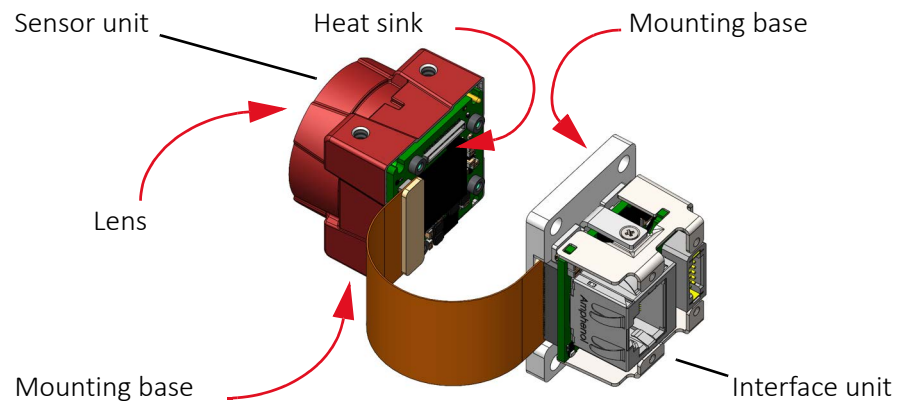

Figure 4: Heat dissipation for Alvium G1 BL cameras



More information

For more information on heat dissipation, see the [Optimum Heat Dissipation for Alvium Cameras](#) application note at www.alliedvision.com/en/support/technical-documentation/alvium-csi-2-documentation.

Camera mounting

Cameras must be mounted using the mounting threads. If vibration is higher than specified, cameras can disconnect from the mounting. Falling cameras can hurt you. To avoid personal injury:

- Mount the camera according to the instructions in [Mounting Alvium G1 cameras](#) on page 193.
- Ensure, shock and vibration do not exceed the specified range, see [Shock and vibration](#) on page 55.
- Use a lens support if you want to use [Heavy lenses](#).

Heavy lenses

For non-static applications, use lenses with a mass less than 140 grams and a length less than 38 mm, where the center of gravity is 20 mm, measured from the lens mount front flange. For heavier or longer lenses, use a lens support and apply additional tests. For more information, please contact support at www.alliedvision.com/en/about-us/contact-us/technical-support-repair-/-rma.



Applied mechanical tests

See [Shock and vibration](#) on page 55 for standards compliance.

Product safety

To prevent material damage, read the following and understand how to safely handle and operate the camera. Get helpful details about electrical connections and learn how to optimize camera performance.

Electrical connections

ESD

Follow these instructions to avoid damage to the camera, including possible **damage to the sensor**, see the note in [Sensor](#) on page 51. ESD is dangerous for electronic devices, especially when tools or hands get in contact with connectors and electronic components. We recommend measures to avoid damage by ESD:

- Unpacking: Remove the camera from its anti-static packaging only when your body is grounded.
- Workplace: Use a static-safe workplace with static-dissipative mat and air ionization.
- Wrist strap: Wear a static-dissipative wrist strap to ground your body.
- Clothing: Wear ESD clothing. Keep components away from your body and clothing. Even if you are wearing a wrist strap, your body is grounded but your clothes are not.
- Screw-locks: Tighten screw locks of all cabling prior powering the camera. Do not touch locking screws during operation to prevent camera malfunction.

Cable connections

Provide sufficient strain relief for all cable connections to avoid short circuits and malfunctions.

Camera power

Operating the camera beyond the specified range damages the camera.

Cameras can be powered using the I/O connector at an input range of 12 to 24 VDC, using a limited power source (LPS), according to IEC 62368-1 with minimum 2.0 A. The camera is not intended to be connected to a DC distribution network.

Alternatively, cameras can be powered over Ethernet. However, power consumption and heat generation are higher than with external power, using the I/O connector.

- **Never use PoE and external power at the same time.** Otherwise, the camera is damaged.
- Make sure that PoE power sourcing equipment is at least compliant to IEEE 802.3af.
- Only use power supplies that meet the insulation requirement according to PELV or SELV. For details, please refer to IEC 61140.
- If using external power supplies by third-party manufacturers, observe polarity to avoid damage to the camera electronics.



PoE versus external power

Powering the camera via PoE results in higher power consumption and heat generation than external power, resulting in higher energy costs and requiring more efficient heat dissipation.



External power supply

For the 13870 10-pin TFM power supply, see www.alliedvision.com/en/support/accessory-documentation.

PoE Power Sourcing Equipment (PSE)

Damage to the camera or connected peripherals can occur if PSE is not galvanically isolated from mains and other electrical connections towards the camera (other than Ethernet signals and shield ground).

To avoid damage

- **Never use PoE and external power at the same time.** Otherwise, the camera is damaged.
- Only use IEEE802.3af/at compliant PSE equipment to power the camera via PoE.
- Ensure the PSE is galvanically isolated from mains and all other electrical connections towards the camera.

I/Os and power supply by PoE

The PoE implementation is non-isolated. Therefore, when the camera is connected to a PoE-capable Ethernet port:

- Only connect the pins 3, 4, 5, 6 and 10 (isolated I/Os) of the TFM connector.
- **Do not** connect any other pins of the TFM connector.

See [Camera interfaces](#) on page 214 for details.

I/Os

To avoid damage to the camera, keep the maximum values for

- Isolated I/Os: Input voltage below 24 VDC, output current below 20 mA per output.
- Non-isolated GPIOs: Input voltage below 5.5 VDC, output current below 12 mA.

See [Alvium G1 model specifications](#) on page 66 for details. The maximum length for I/O cables must not exceed 30 meters.



Power supply via I/O cables

If you power the camera via an I/O cable, consider the voltage drop to meet the minimum supply voltage for the camera.

GigE connection

GigE NICs

To avoid damage to GigE NICs and injectors, make sure that PoE power sourcing equipment is at least compliant to IEEE 802.3af.



GigE accessories

For GigE interface cables, NICs, switches, and more, see www.alliedvision.com/en/support/accessory-documentation.

Ethernet cables

Proper cable handling enables reliable performance:

- We recommend Category 6 (CAT6) or higher rated Ethernet cables for Alvium G1 cameras. A different rating may not sustain peak interface bandwidth; leading to lost connectivity or dropped frames coming from the camera. .
- Use only shielded cables to avoid electromagnetic interferences.
- Please use cables recommended by Allied Vision.
- Avoid unnecessary bending to prevent damage to the cables.
- Avoid coiling to prevent electromagnetic interference.

Optical components

Provide the following conditions to keep dirt and droplets out of the optical system of camera and lens:

- Dust-free environment
- Low relative humidity
- No condensation.

When camera or lens are stored:

- Cover the lens mount with a protection foil or cap.
- Cover front and back lens with caps.

Sensor

Sensors are sensitive to excessive radiation: focused sunlight, UV light, lasers, and X-rays can damage the sensor. Dirt and scratches can damage the sensor as well.

Alvium G1 cameras do not need additional cleaning. Cameras are cleaned before shipping. Incorrect cleaning can damage the sensor or the filter. Therefore, never clean the sensor or the filter.

Protect the camera filter and the sensor from dirt, because dirt becomes more visible the closer it gets to the sensor. In addition, keep the back lens clean. Hold the camera with the lens mount facing the ground to keep dirt out of the lens mount. When no lens is mounted, protect the sensor and filter by a dust cap.

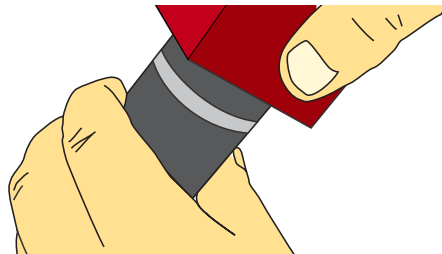

Figure 5: Holding the camera with the lens mount facing the ground

Possible damage to image sensors due to electrostatic charge

Generally, bare board cameras and cameras with incomplete housings are very sensitive to electrostatic discharge (ESD) as electronics components are not protected.

In some rare cases, electrostatic charge occurring on the surface of the image sensor may cause damages to particular pixel groups, which may become visible as bubbles or blobs in the image generated by the sensor.

Therefore, it is very important to comply with ESD protection measures in accordance with technical standards.

Follow the instructions in [ESD](#) on page 48.

Sensor cleanliness

Definitions for Alvium cameras are shown in [Table 9](#):

Sensor family	Aperture*	Visible particles quantity	Max. cluster size	Max. cluster quantity
			Pixels at f1/8.0	At f1/8.0
e2v	f1/4.0	0	30	2
ON Semi	f1/4.0	0	30	2
Sony	f1/8.0	0	0	0

* The incident beam (not related to the lens' angle of view) is $\geq 7^\circ$ for f1/8.0 and $\geq 14^\circ$ for f1/4.0.

Table 9: Sensor cleanliness definitions

Alvium cameras are manufactured to match the requirements of typical machine vision applications. This enables a clean image for typical monitor view. Particles may become visible when the image is viewed critically, such as with contrast enhancement or edge detection.



Advanced sensor cleanliness

If standard definitions for Alvium do not fulfill the requirements of your application, please contact your Allied Vision Sales representative or visit www.alliedvision.com/en/about-us/contact-us/technical-support-repair-/rma.

Lenses

Maximum protrusion

The sensor, filter, or lens can be damaged if a lens exceeding maximum protrusion is mounted to the camera. Use lenses with a maximum protrusion within camera specifications. [Figure 6](#) shows schematics for maximum protrusion. For details, see [Lens mounts and maximum protrusion](#) on page 167.

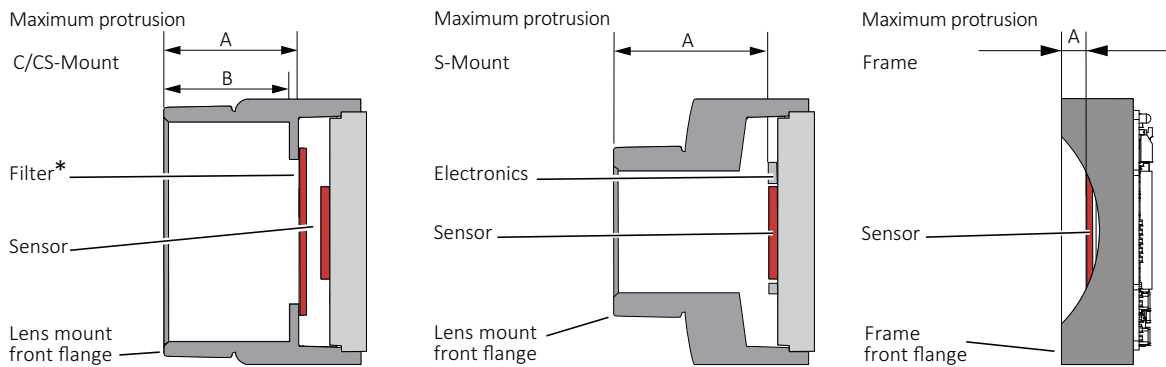

*Only color models are equipped with an IR cut filter

Figure 6: Maximum protrusion CS-Mount and C-Mount, S-Mount, Frame

For S-Mount lenses, read [Mounting and focusing S-Mount lenses](#) on page 205 to avoid damage to the sensor, the electronics, and lens.

Mechanical components

Heat sinks

Heat sinks can be used to cool the camera for safety and to improve image quality. Adhere to the instructions provided by the manufacturer of the heat sink.

Conductive media

Some conductive media for heat sinks contain corrosive substances that can damage optical surfaces of the sensor, filter, and lens.

- Cover the optical path of the camera when you apply heat sink compound or adhesive to prevent substances and fumes from damaging optical surfaces.
- Adhere to the instructions and safety notes provided by the manufacturer of the conductive media.
- Ensure that the conductive media is correctly positioned: covering only the components to be cooled.

Specifications



This chapter includes:

Applied standards	55
Notes on specifications.....	58
Alvium G1 model specifications.....	66
White balance default.....	154
G1 Closed Housing: Dimensions and mass.....	155
G1 Closed Housing: Technical drawings	155
Alvium G1 BL: Dimensions and mass.....	155
Alvium G1 BL: Technical drawings	155
Lens mounts and maximum protrusion.	167
IR cut filter.....	168
Sensor position accuracy	169
User sets.....	171
Camera feature availability	172

Applied standards

GenICam

GenICam provides a generic access to cameras and devices that is independent of the interface. This enables operating cameras with USB3 Vision, GigE Vision, or CoaXPress interfaces with a common software.

GenICam consists of multiple modules for different tasks. Allied Vision cameras and software use these modules, such as the SFNC that standardizes feature names and types via an XML file.

Alvium G1 cameras comply to:

- GigE Vision Standard Version 2.2
- GenICam Standard Document Version 2.1.1
- GenAPI Schema Version 1.1
- GenAPI Version 3.1
- GenICam Standard Features Naming Convention (SFNC) Version 2.7
- GenICam Pixel Format Naming Convention (PFNC) Version 2.2

GigE Vision

The GigE Vision standard specifies a UDP based protocol for machine vision and imaging products. It provides control over compliant devices by GenICam Applications Programming Interface (API). The GigE Vision standard is administered by the Automated Imaging Association (AIA).

IP class

Equipped with a lens as intended, Alvium G1 cameras comply with IP30 class according to IEC 60529.

Shock and vibration



Alvium G1 BL cameras

Shock and vibration tests were done only for standard Alvium G1 Closed Housing cameras. Please do your own testing for Alvium G1 BL cameras, depending on the individual setup.

Standard Alvium G1 Closed Housing cameras were tested successfully according to the following standards:

- IEC 60068-2-6, sinusoidal vibration testing
- IEC 60068-2-27, shock testing
- IEC 60068-2-64, random vibration testing.

Cameras were inspected before and after the tests. All tests were passed successfully:

Condition	Passed
Mechanics	<ul style="list-style-type: none"> The camera housings showed no deformations. The connections between camera components had not come loose. The sensor position was within the specified tolerances of a new camera.
Camera behavior	Camera functionalities were not affected, no deviations occurred.
Image streaming	Images were streamed without errors.

Table 10: Conditions for passed tests

The conditions for cameras and lenses were the same for all tests. Solid aluminum tubes were used to represent real lenses:

Parameter	Value
Lens dummy length	22 mm
Lens dummy mass	70 g
Center of gravity (CoG) ¹	17 mm

¹For camera and lens dummy assemblies, measured from the lens mount front flange

Table 11: Conditions for lenses

IEC 60068-2-6: Sinusoidal vibration

Frequency	Acceleration	Displacement
10 Hz to 58.1 Hz	Not applicable	1.5 mm
58.1 Hz to 500 Hz	20 g	Not applicable

Table 12: Frequency, acceleration, and displacement for IEC 60068-2-6 tests

Parameter	Value
Axis ¹	x, y, z
Sweep rate	1 oct/min
Sweep duration per axis [hh:mm:ss]	03:45:40
Number of sweeps	10

¹For technical reasons, all three axes are tested with the shaker in the upright position without a sliding table.

Table 13: Other parameters for IEC 60068-2-6 tests

IEC 60068-2-27: Shock

Parameter	Value
Axis	x, y, z
Acceleration	20 g
Number of shocks per axis	10
Duration per axis	11 ms
Waveform	Half sine

Table 14: Parameters for IEC 60068-2-27 tests

IEC 60068-2-64: Random vibration

Frequency	Acceleration
15 Hz to 500 Hz	0.05 g ² /Hz

Table 15: Frequency and acceleration for IEC 60068-2-64 tests

Parameter	Value
Axis	x, y, z
Acceleration RMS (Sigma)	4.9 g
Acceleration peak (Sigma)	14.8 g
Duration per axis [hh:mm:ss]	00:30:00

Table 16: Other parameters for IEC 60068-2-64 tests

Notes on specifications

This section defines the conditions for specifications stated in this chapter.

Sensor

Absolute QE plots

Measurements for color cameras were done with IR cut filter. Measurements for monochrome and S-Mount cameras were done without optical filters. With protection glass or filters, QE decreases by approximately 10 percent.

The uncertainty in measurement of the QE values is ± 10 percent. This is mainly due to uncertainties in the measuring apparatus itself (such as Ulbricht sphere and optometer).

Manufacturing tolerance of the sensor increases overall uncertainty.

ON Semiconductor sensors

The curve in the absolute QE plots shown in this chapter is taken from the sensor manufacturer data sheet. The information was correct at the time of publishing.

Sony sensors

Sony provides relative response curves in their sensor data sheets. To create the absolute QE plots shown in this chapter, the relative response was converted to a normalized QE response and then adjusted as per three measured QE values (at 448 nm, 529 nm, 632 nm) for color sensors and one measured QE value (at 529 nm) for monochrome sensors.

Wavelength

The wavelength range in the absolute QE plots reflects the information available in the sensor manufacturer data sheet at the time of publishing. Many color sensors are documented by the sensor manufacturer only for wavelengths from 400 nm to 700 nm.

Spectral response plots

The curves in the spectral response plots shown in this chapter were calculated from measured quantum efficiencies at 448 nm, 529 nm, and 632 nm. The shape of the curve is taken from the sensor data sheet, but the values have been adjusted based on these measured values. The uncertainty in measurement of the spectral response values is ± 10 percent.

Exposure time and frame rates



Exposure time values

Values for exposure time ranges were measured with FW V00.12.00.00611a22. Minimum exposure times with FW V00.13.00.71d891fe have been reduced for all Alvium G1 models, except for Alvium G1-500, G1-1240, and G1-2050. Measurements will be published in a future version of this document.

Specified values

Stated values were calculated (see [Operation for maximum frame rates](#)), then verified with the [Reference system](#) on page 252.

Operation for maximum frame rates

Values for maximum frame rates and for minimum and maximum exposure time in the specification tables were measured, based on following parameters:

- Factory settings (camera after power up)
- Minimum exposure time
- Full resolution
- Mono8 pixel format or 8-Bit Bayer pixel format
- Camera operation in freerun mode
- Minimum value for `SensorBitDepth` (8-bit sensor ADC readout mode if available)
- Bandwidth required for the corresponding frame rate, as stated in the tables for ROI frame rates.

Bandwidth: Values were measured for 12 MByte/s and 122 MByte/s.

Bit depth: Values are measured for Mono8. If you are using color formats or 10-bit or 12-bit pixel formats, frame rates fall below values for Mono8.

If `DeviceLinkThroughputLimit` is enabled, you can increase the `DeviceLinkThroughputLimit` value to increase maximum frame rates.

Triggering: See [Frame rates with rolling shutter sensors](#) on page 61.

Deviations from stated frame rates can occur, especially when:

- The camera is operated in triggered mode
- Low bandwidth is used
- Small ROIs are used.

Factors for exposure time and frame rates

- The **default bandwidth** for Alvium G1 cameras is 115 MByte/s. For some models, you can achieve higher frame rates by increasing values for `DeviceLinkThroughputLimit`. See [Operating systems and bandwidth](#) on page 250.
- Available values and increments for **exposure time** depend on other controls, such as `DeviceLinkThroughputLimit`. See [Value changes by feature interdependencies](#) on page 246.

- For **delays**, see [Exposure start delay = exposure area – exposure time](#). on page 227.
- Calculation of maximum **frame rates for different ROIs** for Alvium G1 cameras does not allow to give a formula. [Operation for maximum frame rates](#) on page 59 defines the conditions for measuring ROI frame rates.

Sensor ADC readout modes for maximum frame rates

If you are using pixel formats that do not require 12-bit sensor ADC readout and you want to achieve higher frame rates, you can select between readout modes for 12-bit, 10-bit, and 8-bit with some Alvium G1 camera models. See your model's specifications.

By default, Alvium G1 models use the maximum bit depth for **SensorBitDepth**. For selected models, *Adaptive* mode switches automatically between 12-bit and 10-bit sensor ADC readout, depending on the bit depth of the selected pixel format. This allows to reduce bandwidth and increase frame rates when only 10-bit is required.

To enable the 8-bit sensor readout mode, you must switch manually, using **SensorBitDepth**. Please observe that the image brightness changes when you switch between 8-bit sensor ADC readout mode and the other readout modes.

Keep in mind that changing the output bit depth of the sensor also affects the minimum available exposure time of the camera.

Exposure time behavior regarding ExposureMode

This section informs about how exposure time behaves in the different exposure modes. All Alvium cameras have an exposure time offset. The exposure time offset and the exposure time increment depend on sensor and camera characteristics. Both, the exposure time offset and the exposure time increment, can change if **Width**, **PixelFormat**, or **DeviceLinkThroughputLimit** are changed. See [Value changes by feature interdependencies](#) on page 246.

ExposureMode = Timed

For all Alvium cameras, exposure time can be set by **ExposureTime** or **ExposureAuto**. For this, **ExposureMode** is set to *Timed*.

The selected exposure time is extended automatically:

- If the selected exposure time does not match the available increment, the camera automatically extends the exposure time to the next increment.
- The **exposure time offset is included** in the selected exposure time.

ExposureMode = TriggerWidth or TriggerControlled

In addition, most global shutter (GS) cameras can control exposure time by the trigger signal, with the **ExposureMode** set to *TriggerWidth* or *TriggerControlled* (using **ExposureStart** and **ExposureStop**).

The trigger controlled exposure time is extended automatically:

- If the trigger controlled exposure time does not match the available increment, the camera automatically extends the exposure time to the next increment.
- Subsequently, the **exposure time offset is added**.

You can use *ExposureActive* to determine the duration of the exposure time offset.

Triggering and sensor shutter types

Triggering behavior differs between cameras with global shutter (GS) and electronic rolling shutter (ERS).

Frame rates with rolling shutter sensors

The following table shows how the shutter mode impacts available frame rates. Reducing the area for ROI reduces readout time. The values in [Table 17](#) apply only if exposure time is shorter than readout time.

Sensor type	Shutter mode	Trigger mode	Frame rates at full resolution*	ROI frame rates
All models, except for...	Global shutter (GS)	Freerun	100%	Increased values
	Global shutter (GS)	External trigger	100%	
G1-500	Rolling shutter (RS)	Freerun	100%	Increased values
	Rolling shutter (RS)	External trigger	>50%	
G1-1240	Rolling shutter (RS)	Freerun	100%	No increase
	Rolling shutter (RS)	External trigger	>99%	
	Global reset shutter (GRS)	Freerun	>99%	
	Global reset shutter (GRS)	External trigger	>99%	
G1-2050	Rolling shutter (RS)	Freerun	100%	Increased values
	Rolling shutter (RS)	External trigger	>99%	
	Global reset shutter (GRS)	Freerun	>99%	
	Global reset shutter (GRS)	External trigger	>99%	

*Related to the values for maximum frame rates stated in the specification tables for each model.

Table 17: Frame rates depending on shutter modes and trigger modes



Achieved frame rates may not match specified values

- Some sensors have an exposure start jitter that may reduce maximum frame rates.
- Your individual setup may cause delays in data transmission.



Bandwidth adjustments

Consider the bandwidth available for camera payload depends on your individual hardware, the operating system, software and drivers, and your application. We recommend you to adjust `DeviceLinkThroughputLimit` to your requirements.



Interdependencies between ROI and ExposureTime values

Changing parameters for ROI can affect values for `ExposureTime`, such as minimum, maximum, and increments, but `ExposureTime` itself as well. We recommend you to set:

- ROI values
- `DeviceLinkThroughputLimit`

before you set values for `ExposureTime`.

See [Value changes by feature interdependencies](#) on page 246 for details.

Sensor shutter types

Differences between global shutter (GS), rolling shutter (RS), and global reset shutter (GRS) sensors are explained in [Shutter types affecting image readout](#) on page 249. Triggering behavior differs between cameras with global shutter (GS) and rolling shutter (RS). See [Triggering and timings](#) on page 225 for details.

Brightness with G1-812 UV cameras

When the sensor is exposed to light above 400 nm wavelength, the PLS (parasitic light sensitivity) effect occurs: The brightness level increases from the bottom to the top of the image.

Digital binning

Alvium G1 cameras combine digital horizontal binning and digital vertical binning, for integer values 1 to 8.



Alvium G1 models ≥ 12 MP resolution

If digital horizontal and digital vertical binning are set to 1x and the digital vertical binning value is increased, digital horizontal binning is automatically set to 2x.

Sensor binning

Selected camera models support sensor binning in addition. See the specifications tables in [Alvium G1 model specifications](#) on page 66.

Multiple regions

All Alvim G1 models support single ROI (region of interest). Because multiple ROI (**MultipleRegions** features) are sensor based, it is not supported by all camera models. With all the corresponding models, *Free* mode is available for **MultipleRegionArrangement** with 1 to 4 subregions. Other models also support *Tile* mode, some models also support *Horizontal* and *Vertical* mode with 1 to 4 subregions. See [Table 18](#).





Mode	Sensor input	Camera output
<i>Free</i>		
<i>Tile</i>		
<i>Horizontal</i>		
<i>Vertical</i>		

Table 18: Modes for MultipleRegions

See the specifications tables in [Alvim G1 model specifications](#) on page 66 for **MultipleRegionArrangement** options and [Available subregion resolutions](#) on page 64.

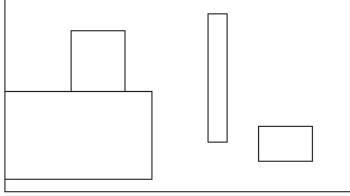

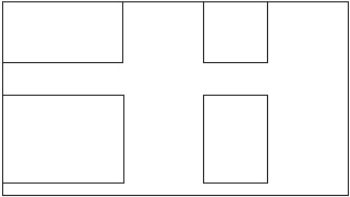
Using multiple regions

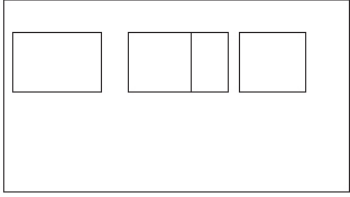
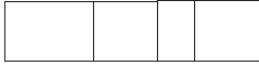
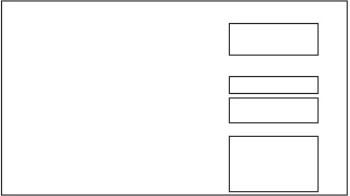
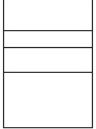
Alvim Features Reference: www.alliedvision.com/en/support/technical-documentation/alvim-gige-documentation.

Available subregion resolutions

Table 19 shows the available total pixel resolutions when multiple regions are enabled. How are these values applied?

Alvium G1-2460 supports 1 to 4 subregions in *Horizontal* mode.

Example

Subregions could be 608×8 , 608×8 , 2048×8 , and 1920×8 , with a minimum width of 608 pixels per subregion and a minimum height of 8 pixels.



Minimum width for subregions

We are working on a future solution to enable smaller width values.

The same working principle applies to *Vertical* mode correspondingly.

Alvium model	Sensor	Minimum subregion	Maximum subregion
G1-030 VSWIR	IMX991	8×8	656×520
G1-040	IMX287	260×4	728×544
G1-130 VSWIR	IMX990	8×8	1296×1032
G1-131	EV76C560	Not supported	
G1-158	IMX273	260×4	1456×1088
G1-192	EV76C570	Not supported	
G1-234	IMX249	92×2	1936×1216
G1-240	IMX392	260×4	1936×1216
G1-319	IMX265	260×4	2064×1544
G1-500	AR0521	Not supported	
G1-507 ¹	IMX264	260×4	2464×2056
G1-510	IMX548	608×8	2464×2064
G1-811	IMX546	608×8	2848×2848
G1-812 UV	IMX487	608×16	2848×2848
G1-895	IMX267	260×4	4112×2176
G1-1236	IMX304	260×4	4112×3008
G1-1240	IMX226	Not supported	
G1-1242	IMX545	608×8	4128×3008

¹ Including Pol models

Table 19: Available subregion resolutions (sheet 1 of 2)

Alvium model	Sensor	Minimum subregion	Maximum subregion
G1-1620	IMX542	608 × 8	5328 × 3040
G1-2040	IMX541	608 × 8	4512 × 4512
G1-2050	IMX183	Not supported	
G1-2460	IMX540	608 × 8	5328 × 4608

Table 19: Available subregion resolutions (sheet 2 of 2)

Operation for typical power consumption

Values for typical power consumption and housing temperature ranges in the specification tables are based on following parameters:

- Factory settings (camera after power up)
- Minimum exposure time
- Maximum frame rate
- Full resolution
- Mono8 pixel format or 8-Bit Bayer pixel format
- Camera operation in freerun mode
- Sensor ADC readout using maximum bit depth
- Without bandwidth limitations.

Dimensions and mass

For your model's dimensions, see [G1 Closed Housing: Dimensions and mass](#) on page 155. For technical drawings, see [G1 Closed Housing: Technical drawings](#) on page 155.

Alvium G1 model specifications

Alvium G1-030 VSWIR

Feature	Specification
	G1-030 VSWIR
Sensor model	Sony IMX991
Resolution	656 (H) × 520 (V); 0.3 MP
Sensor type	InGaAs
Shutter type	Global shutter (GS)
Sensor size	Type 1/4; 3.3 mm × 2.6 mm; 4.1 mm diagonal
Pixel size	5 μm × 5 μm
CRA	0 deg
Sensor bit depth (ADC)	8-bit, 10-bit, 12-bit; Adaptive (10-bit, 12-bit)
Monochrome pixel formats	Mono8 (default), Mono10, Mono10p, Mono12, Mono12p, Mono12Packed
Maximum frame rate	249 fps (at 122 MByte/s)
Exposure time	15 μs to 10 s (at 122 MByte/s)
Exposure modes	Timed, TriggerControlled, TriggerWidth
Gain	0 dB to 42 dB; 0.1 dB increments
Digital binning	Horizontal: 1 to 8 columns; Vertical: 1 to 8 rows
Multiple ROI (H × V)	<i>Free Tile Horizontal</i> : 1 × 1 to 1 × 4 <i>Vertical</i> : 1 × 1 to 4 × 1
Image buffer (RAM)	32 MByte
Non-volatile memory (Flash)	1024 KByte
Inputs and outputs	1 opto-isolated input, 1 opto-isolated output, 2 non-isolated GPIOs ¹
Power requirements	12 to 24 VDC
Power requirements (PoE)	IEEE 802.3af
Power consumption (typical)	External power: 2.8 W at 12 VDC Power over Ethernet: 3.1 W

¹ Use with external power only, not with PoE. See [I/Os and power supply by PoE](#) on page 50.

Table 20: Alvium G1-030 VSWIR specifications (sheet 1 of 2)

Feature	Specification			
Storage temperature	-20 °C to +85 °C ambient temperature			
Operating temperature	Hardware option	Housing ²	Cooling areas ³	Mainboard ⁴
	G1 BL No Mount ⁵	-20 °C to +65 °C	-20 °C to +85 °C	-20 °C to +85 °C
	G1 BL with mount ⁶	-20 °C to +65 °C	-20 °C to +85 °C	
	Closed Housing	-20 °C to +65 °C	Not applicable	
Relative humidity	0% to 80% (non-condensing)			
Digital interface	1000BASE-T			
Camera controls	GenICam (GenICam Access)			

² Including the interface unit for G1 BL models

³ See [Heat dissipation for Alvium G1 BL](#) on page 192 and [Mounting the G1 BL interface unit](#) on page 201.

⁴ Output by `DeviceTemperature`

⁵ Ensure that the sensor is operated in the temperature range specified by the manufacturer. For any questions, please visit www.alliedvision.com/en/support.

Housing temperature applies to the interface unit only.

⁶ Temperature values must be observed for the housing **and** for the cooling areas.

Table 20: Alvium G1-030 VSWIR specifications (sheet 2 of 2)

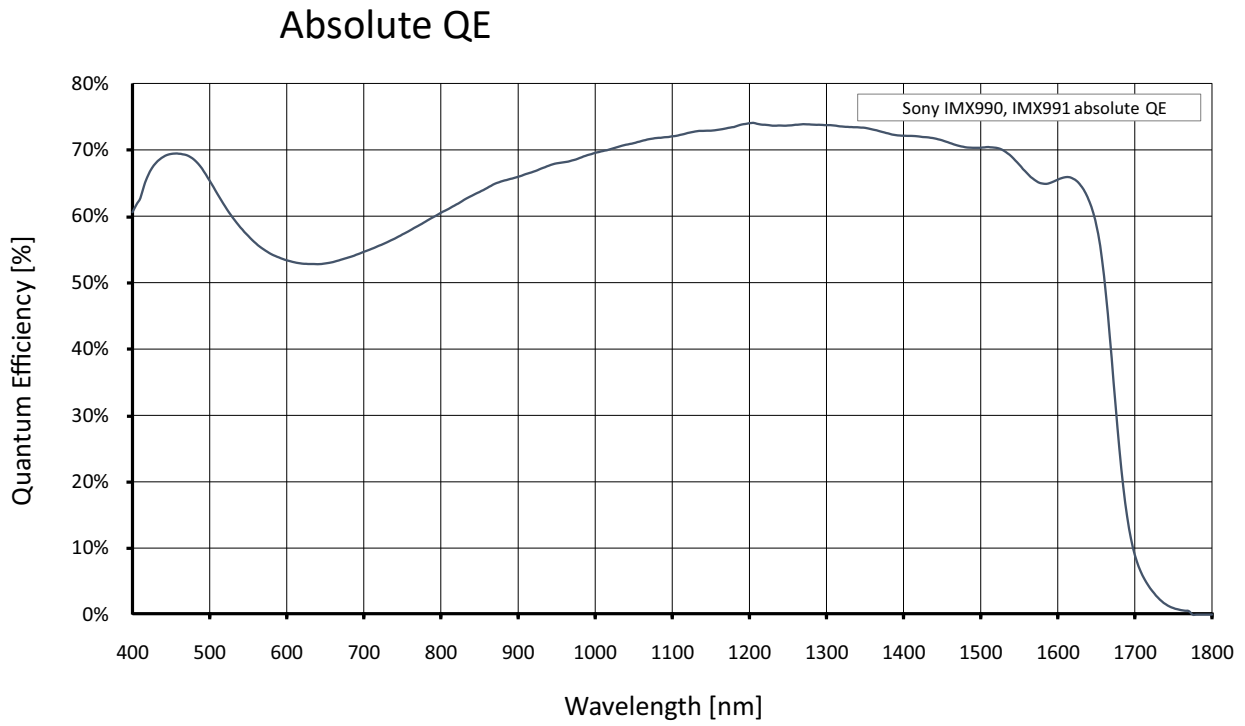

Figure 7: Alvium G1-030 VSWIR (Sony IMX991) absolute QE

ROI frame rates

Values are based on the conditions defined in [Specified values](#) on page 59.

Image format	Width [pixels]	Height [pixels]	ROI area [MP]	Frame rate [fps] ¹	
				122 MByte/s	12 MByte/s
Full resolution	656	520	0.341	249.2/173.3/133.0	34.1/17.1/17.1
VGA	640	480	0.307	267.9/192.4/143.0	37.9/18.9/18.9
HVGA	480	320	0.154	384.9/356.4/205.2	75.6/37.8/37.8
QVGA	320	240	0.077	492.4/457.2/262.7	150.9/75.6/75.6
HQVGA	240	160	0.038	683.2/634.4/365.0	300.6/151.0/150.9
QQVGA	160	120	0.019	849.9/789.2/454.6	594.9/300.7/300.1
Max. × half	656	260	0.171	450.4/346.2/241.0	68.1/34.1/34.1
Max. × min.	656	8	0.005	2340.8/2138.5/1286.8	2099.8/1077.9/1069.3
Min. × max.	8	520	0.004	251.8/234.3/134.1	
Min. × min.	8	8	64 P	2644.2/2410.7/1405.9	

¹ Mono8 at SensorBitDepth = 8-Bit⁽²⁾ / Mono10 at SensorBitDepth = 10-Bit / Mono12 or at SensorBitDepth = 12-Bit

² The SensorBitDepth value must be set separately from PixelFormat.
See [Sensor ADC readout modes for maximum frame rates](#) on page 60 for details.

Table 21: Alvium G1-030 VSWIR ROI frame rates

Alvium G1-040m/c

Feature	Specification	
	G1-040m (monochrome)	G1-040c (color)
Sensor model	Sony IMX287	
Resolution	728 (H) × 544 (V); 0.4 MP	
Sensor type	CMOS	
Shutter type	Global shutter (GS)	
Sensor size	Type 1/2.9; 5.0 mm × 3.8 mm; 6.3 mm diagonal	
Pixel size	6.9 μm × 6.9 μm	
CRA	0 deg	
Sensor bit depth (ADC)	8-bit, 10-bit, 12-bit; Adaptive (10-bit, 12-bit)	
Monochrome pixel formats	Mono8 (default), Mono10, Mono10p, Mono12, Mono12p, Mono12Packed	Mono8, Mono10, Mono10p, Mono12, Mono12p, Mono12Packed
YUV color pixel formats	Not applicable	YCbCr411_8_CbYYCrYY, YCbCr422_8_CbYCrY, YCbCr8_CbYCr
RGB color pixel formats	Not applicable	BGR8, RGB8 (default)
Raw color pixel formats	Not applicable	BayerRG8, BayerRG10, BayerRG10p, BayerRG12, BayerRG12p, BayerRG12Packed
Maximum frame rate	298 fps (at 122 MByte/s)	
Exposure time	21 μs to 10 s (at 122 MByte/s)	
Exposure modes	Timed, TriggerControlled, TriggerWidth	
Gain	0 dB to 48 dB; 0.1 dB increments	
Digital binning	Horizontal: 1 to 8 columns; Vertical: 1 to 8 rows	
Multiple ROI (H × V)	<i>Free</i>	
Image buffer (RAM)	32 MByte	
Non-volatile memory (Flash)	1024 KByte	
Inputs and outputs	1 opto-isolated input, 1 opto-isolated output, 2 non-isolated GPIOs ¹	
Power requirements	12 to 24 VDC	
Power requirements (PoE)	IEEE 802.3af	
Power consumption (typical)	External power: 3.1 W at 12 VDC Power over Ethernet: 3.4 W	

¹ Use with external power only, not with PoE. See [I/Os and power supply by PoE](#) on page 50.

Table 22: Alvium G1-040m/c specifications (sheet 1 of 2)

Feature	Specification			
Storage temperature	-20 °C to +85 °C ambient temperature			
Operating temperature	Hardware option	Housing ²	Cooling area ³	Mainboard ⁴
	G1 BL No Mount ⁵	-20 °C to +65 °C	-20 °C to +85 °C	-20 °C to +85 °C
	G1 BL with mount ⁶	-20 °C to +65 °C	-20 °C to +85 °C	
Closed Housing	-20 °C to +65 °C	Not applicable		
Relative humidity	0% to 80% (non-condensing)			
Digital interface	1000BASE-T			
Camera controls	GenICam (GenICam Access)			

² Including the interface unit for G1 BL models

³ See [Heat dissipation for Alvium G1 BL](#) on page 192 and [Mounting the G1 BL interface unit](#) on page 201.

⁴ Output by DeviceTemperature

⁵ Ensure that the sensor is operated in the temperature range specified by the manufacturer. For any questions, please visit www.alliedvision.com/en/support.

Housing temperature applies to the interface unit only.

⁶ Temperature values must be observed for the housing **and** for the cooling areas.

Table 22: Alvium G1-040m/c specifications (sheet 2 of 2)

Absolute QE

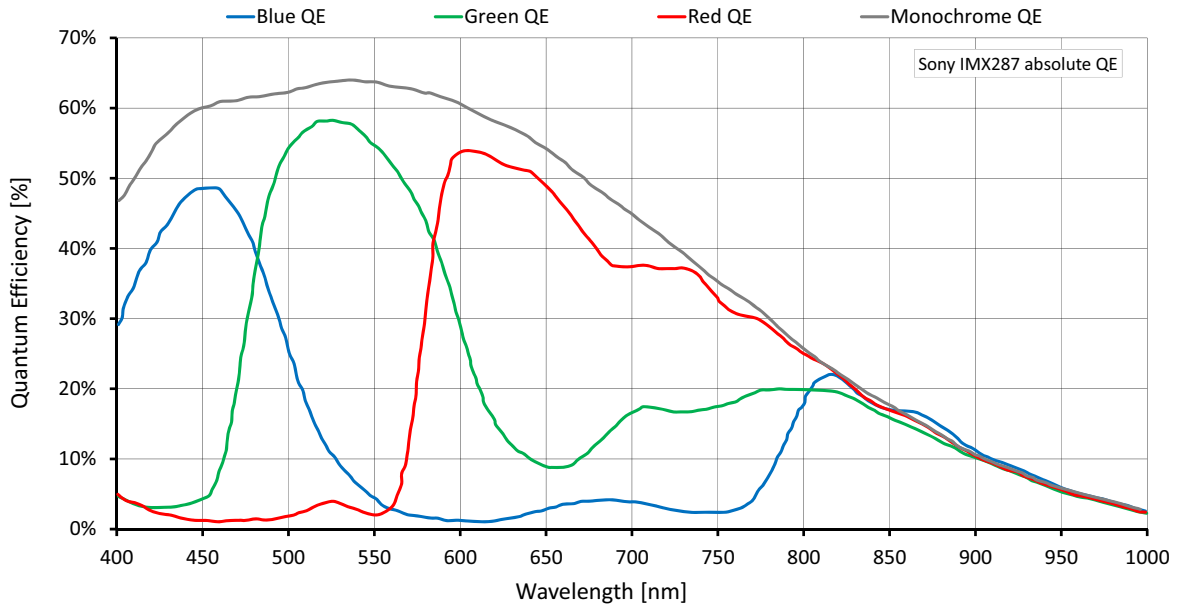

Figure 8: Alvium G1-040m/c (Sony IMX287) absolute QE

Spectral response

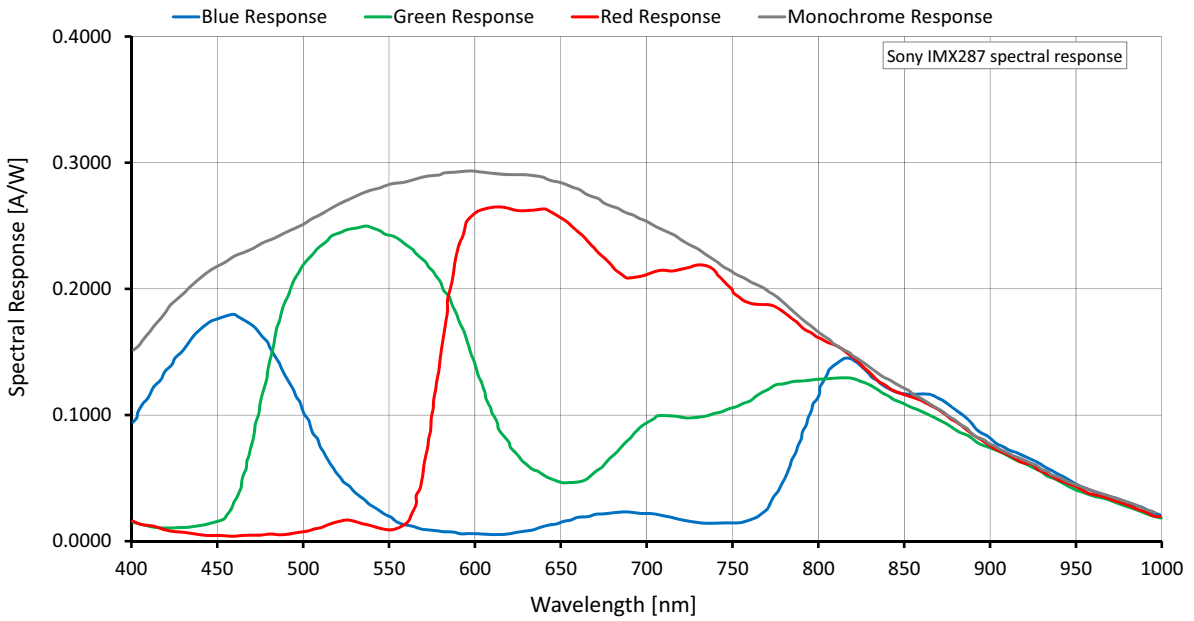

Figure 9: Alvium G1-040m/c (Sony IMX287) spectral response

ROI frame rates

Values are based on the conditions defined in [Specified values](#) on page 59.

Image format	Width [pixels]	Height [pixels]	ROI area [MP]	Frame rate [fps] ¹	
				122 MByte/s	12 MByte/s
Full resolution	728	544	0.396	298.6/149.3/149.3	29.4/14.7/14.7
VGA	640	480	0.307	384.7/192.6/192.4	37.9/18.9/18.9
HVGA	480	320	0.154	768.4/384.9/384.8	75.6/37.9/37.9
QVGA	320	240	0.077	988.0/767.4/617.7	150.9/75.7/75.6
HQVGA	240	160	0.038	1340.5/1138.9/847.2	300.7/151.0/150.9
QQVGA	160	120	0.019	1627.3/1390.6/1037.6	596.7/300.7/300.3
Max. × half	728	272	0.198	596.7/298.4/298.4	58.7/29.4/29.4
Max. × min.	728	8	0.006	3803.7/2608.0/2462.6	1901.9/971.3/972.1
Min. × max.	8	544	0.004	497.2/416.0/306.8	
Min. × min.	8	8	64 P	4057.3/3647.7/2798.5	

¹ Mono8 or Bayer...8⁽²⁾ at SensorBitDepth = 8-Bit⁽³⁾ /
 Mono10 or Bayer...10 at SensorBitDepth = 10-Bit /
 Mono12 or Bayer...12 at SensorBitDepth = 12-Bit

² The three dots... represent the colors of a Bayer pixel format, such as in Bayer**RG8**.

³ The SensorBitDepth value must be set separately from PixelFormat.
 See [Sensor ADC readout modes for maximum frame rates](#) on page 60 for details.

Table 23: Alvium G1-040m/c ROI frame rates

Alvium G1-130 VSWIR

Feature	Specification
	G1-130 VSWIR
Sensor model	Sony IMX990
Resolution	1296 (H) × 1032 (V); 1.3 MP
Sensor type	InGaAs
Shutter type	Global shutter (GS)
Sensor size	Type 1/2; 6.4 mm × 5.1 mm; 8.2 mm diagonal
Pixel size	5 μm × 5 μm
CRA	0 deg
Sensor bit depth (ADC)	8-bit, 10-bit, 12-bit; Adaptive (10-bit, 12-bit)
Monochrome pixel formats	Mono8 (default), Mono10, Mono10p, Mono12, Mono12p, Mono12Packed
Maximum frame rate	88 fps (at 122 MByte/s)
Exposure time	19 μs to 10 s (at 122 MByte/s)
Exposure modes	Timed, TriggerControlled, TriggerWidth
Gain	0 dB to 42 dB; 0.1 dB increments
Digital binning	Horizontal: 1 to 8 columns; Vertical: 1 to 8 rows
Multiple ROI (H × V)	<i>Free Tile Horizontal</i> : 1 × 1 to 1 × 4 <i>Vertical</i> : 1 × 1 to 4 × 1
Image buffer (RAM)	32 MByte
Non-volatile memory (Flash)	1024 KByte
Inputs and outputs	1 opto-isolated input, 1 opto-isolated output, 2 non-isolated GPIOs ¹
Power requirements	12 to 24 VDC
Power requirements (PoE)	IEEE 802.3af
Power consumption (typical)	External power: 2.9 W at 12 VDC Power over Ethernet: 3.2 W
¹ Use with external power only, not with PoE. See I/Os and power supply by PoE on page 50.	

Table 24: Alvium G1-130 VSWIR specifications (sheet 1 of 2)

Feature	Specification			
Storage temperature	-20 °C to +85 °C ambient temperature			
Operating temperature	Hardware option	Housing ²	Cooling area ³	Mainboard ⁴
	G1 BL No Mount ⁵	-20 °C to +65 °C	-20 °C to +85 °C	-20 °C to +85 °C
	G1 BL with mount ⁶	-20 °C to +65 °C	-20 °C to +85 °C	
	Closed Housing	-20 °C to +65 °C	Not applicable	
Relative humidity	0% to 80% (non-condensing)			
Digital interface	1000BASE-T			
Camera controls	GenICam (GenICam Access)			

² Including the interface unit for G1 BL models

³ See [Heat dissipation for Alvium G1 BL](#) on page 192 and [Mounting the G1 BL interface unit](#) on page 201.

⁴ Output by `DeviceTemperature`

⁵ Ensure that the sensor is operated in the temperature range specified by the manufacturer. For any questions, please visit www.alliedvision.com/en/support.

Housing temperature applies to the interface unit only.

⁶ Temperature values must be observed for the housing **and** for the cooling areas.

Table 24: Alvium G1-130 VSWIR specifications (sheet 2 of 2)

Absolute QE

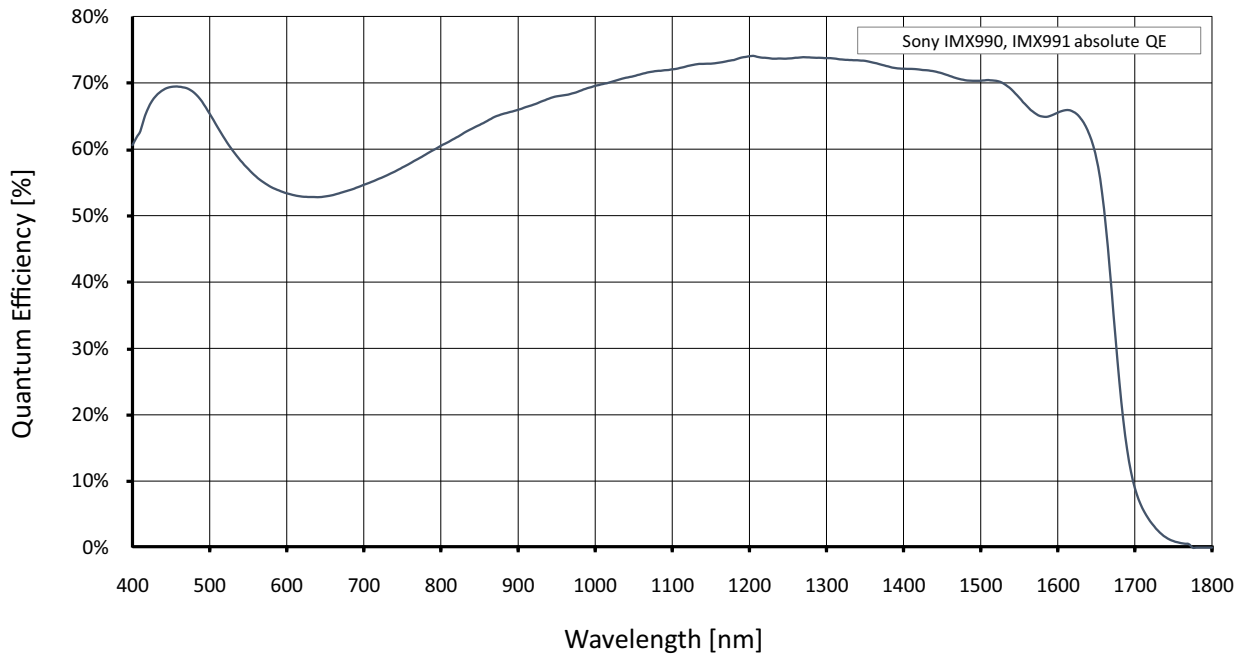

Figure 10: Alvium G1-130 VSWIR (Sony IMX990) absolute QE

ROI frame rates

Values are based on the conditions defined in [Specified values](#) on page 59.

Image format	Width [pixels]	Height [pixels]	ROI area [MP]	Frame rate [fps] ¹	
				122 MByte/s	12 MByte/s
Full resolution	1296	1032	1.337	88.5/44.2/44.2	8.7/4.4/4.4
SXGA	1280	1024	1.311	90.3/45.1/45.1	8.9/4.4/4.4
HD 720	1280	720	0.922	128.4/64.2/64.2	12.6/6.3/6.3
XGA	1024	768	0.786	150.5/75.2/75.2	14.8/7.4/7.4
SVGA	800	600	0.48	218.0/123.2/116.3	24.2/12.1/12.1
VGA	640	480	0.307	267.9/192.4/143.0	37.9/18.9/18.9
HVGA	480	320	0.154	384.9/356.4/205.2	75.6/37.8/37.8
QVGA	320	240	0.077	492.4/457.2/262.7	150.9/75.6/75.6
HQVGA	240	160	0.038	683.2/634.4/365.0	300.6/151.0/150.9
QQVGA	160	120	0.019	849.9/789.2/454.6	594.9/300.7/300.1
Max. x half	1296	516	0.669	176.9/88.5/88.5	17.4/8.7/8.7
Max. x min.	1296	8	0.01	2099.8/1328.2/1168.0	1090.0/553.4/550.1
Min. x max.	8	1032	0.008	132.5/123.0/70.4	
Min. x min.	8	8	64 P	2644.2/2410.7/1405.9	

¹ Mono8 at SensorBitDepth = 8-Bit⁽²⁾ / Mono10 at SensorBitDepth = 10-Bit / Mono12 or at SensorBitDepth = 12-Bit

² The SensorBitDepth value must be set separately from PixelFormat. See [Sensor ADC readout modes for maximum frame rates](#) on page 60 for details.

Table 25: Alvium G1-130 VSWIR ROI frame rates

Alvium G1-131m/c (coming soon)

Feature	Specification	
	G1-131m (monochrome)	G1-131c (color)
Sensor model	e2v EV76C560 Sapphire	
Resolution	1280 (H) × 1024 (V); 1.3 MP	
Sensor type	CMOS	
Shutter type	Global shutter (GS)	
Sensor size	Type 1/1.8; 6.9 mm × 5.5 mm; 8.7 mm diagonal	
Pixel size	5.3 μm × 5.3 μm	
CRA	12 deg	
Sensor bit depth (ADC)	10-bit	
Monochrome pixel formats	Mono8 (default), Mono10, Mono10p, Mono12, Mono12p, Mono12Packed	Mono8, Mono10, Mono10p, Mono12, Mono12p, Mono12Packed
YUV color pixel formats	Not applicable	YCbCr411_8_CbYYCrYY, YCbCr422_8_CbYCrY, YCbCr8_CbYCr
RGB color pixel formats	Not applicable	BGR8, RGB8 (default)
Raw color pixel formats	Not applicable	BayerRG8, BayerRG10, BayerRG10p, BayerRG12, BayerRG12p, BayerRG12Packed
Maximum frame rate	59 fps (at 122 MByte/s)	
Exposure time	16 μs to 10 s (at 122 MByte/s)	
Exposure modes	Timed	
Gain	0 dB to 48 dB; 0.1 dB increments	
Digital binning	Horizontal: 1 to 8 columns; Vertical: 1 to 8 rows	
Image buffer (RAM)	32 MByte	
Non-volatile memory (Flash)	1024 KByte	
Inputs and outputs	1 opto-isolated input, 1 opto-isolated output, 2 non-isolated GPIOs ¹	
Power requirements	12 to 24 VDC	
Power requirements (PoE)	IEEE 802.3af	
Power consumption (typical)	External power: 2.2 W Power over Ethernet: 2.5 W	

¹ Use with external power only, not with PoE. See [I/Os and power supply by PoE](#) on page 50.

Table 26: Alvium G1-131m/c specifications (sheet 1 of 2)

Feature	Specification			
Storage temperature	-20 °C to +85 °C ambient temperature			
Operating temperature	Hardware option	Housing ²	Cooling area ³	Mainboard ⁴
	G1 BL No Mount ⁵	-20 °C to +65 °C	-20 °C to +85 °C	-20 °C to +85 °C
	G1 BL with mount ⁶	-20 °C to +65 °C	-20 °C to +85 °C	
Closed Housing	-20 °C to +65 °C	Not applicable		
Relative humidity	0% to 80% (non-condensing)			
Digital interface	1000BASE-T			
Camera controls	GenICam (GenICam Access)			

² Including the interface unit for G1 BL models

³ See [Heat dissipation for Alvium G1 BL](#) on page 192 and [Mounting the G1 BL interface unit](#) on page 201.

⁴ Output by DeviceTemperature

⁵ Ensure that the sensor is operated in the temperature range specified by the manufacturer. For any questions, please visit www.alliedvision.com/en/support.

Housing temperature applies to the interface unit only.

⁶ Temperature values must be observed for the housing **and** for the cooling areas.

Table 26: Alvium G1-131m/c specifications (sheet 2 of 2)

Absolute QE, spectral response

We intend to add diagrams in a future version of this document.

ROI frame rates

Values are based on the conditions defined in [Specified values](#) on page 59.

Image format	Width [pixels]	Height [pixels]	ROI area [MP]	Frame rate [fps] ¹	
				122 MByte/s	12 MByte/s
Full resolution, SXGA	1280	1024	1.311	59 / 45.5	9 / 4
HD 720	1280	720	0.922	85.6 / 64.1	12.8 / 6
XGA	1024	768	0.786	80.4 / 75.3	15.1 / 7
SVGA	800	600	0.480	102.1 / 102.1	24.5 / 12.2
VGA	640	480	0.307	126.5 / 126.5	37.9 / 18.9
HVGA	480	320	0.154	185.4 / 185.4	74.1 / 37.0
QVGA	320	240	0.077	241.8 / 241.8	144.9 / 72.5
HQVGA	240	160	0.038	347.6 / 347.6	277.7 / 138.9
QQVGA	160	120	0.019	444.8 / 444.8	444.8 / 266.6
Max. × half	1280	512	0.655	118.9 / 89.0	17.8 / 8
Max. × min.	1280	8	0.010	2051.8 / 1536.7	307.4 / 153.7
Min. × max.	8	1024	0.008	59 / 59	
Min. × min.	8	8	64 P	2051.8 / 2051.8	

¹ Mono8 or Bayer...8⁽²⁾ at SensorBitDepth = 10-Bit / Mono10 or Bayer...10 at SensorBitDepth = 10-Bit

² The three dots... represent the colors of a Bayer pixel format, such as in BayerRG8.

Table 27: Alvium G1-131m/c ROI frame rates (calculated values)

Alvium G1-158m/c

Feature	Specification	
	G1-158m (monochrome)	G1-158c (color)
Sensor model	Sony IMX273	
Resolution	1456 (H) × 1088 (V); 1.6 MP	
Sensor type	CMOS	
Shutter type	Global shutter (GS)	
Sensor size	Type 1/2.9; 5.0 mm × 3.8 mm; 6.3 mm diagonal	
Pixel size	3.45 μm × 3.45 μm	
CRA	0 deg	
Sensor bit depth (ADC)	8-bit, 10-bit, 12-bit; Adaptive (10-bit, 12-bit)	
Monochrome pixel formats	Mono8 (default), Mono10, Mono10p, Mono12, Mono12p, Mono12Packed	Mono8, Mono10, Mono10p, Mono12, Mono12p, Mono12Packed
YUV color pixel formats	Not applicable	YCbCr411_8_CbYYCrYY, YCbCr422_8_CbYCrY, YCbCr8_CbYCr
RGB color pixel formats	Not applicable	BGR8, RGB8 (default)
Raw color pixel formats	Not applicable	BayerRG8, BayerRG10, BayerRG10p, BayerRG12, BayerRG12p, BayerRG12Packed
Maximum frame rate	74 fps (at 122 MByte/s)	
Exposure time	27 μs to 10 s (at 122 MByte/s)	
Exposure modes	Timed, TriggerControlled, TriggerWidth	
Gain	0 dB to 48 dB; 0.1 dB increments	
Digital binning	Horizontal: 1 to 8 columns; Vertical: 1 to 8 rows	
Sensor binning (H × V)	1 × 2, 2 × 2 (<i>Sum</i>)	Not applicable
Multiple ROI (H × V)	<i>Free Tile</i>	
Image buffer (RAM)	32 MByte	
Non-volatile memory (Flash)	1024 KByte	
Inputs and outputs	1 opto-isolated input, 1 opto-isolated output, 2 non-isolated GPIOs ¹	
Power requirements	12 to 24 VDC	
Power requirements (PoE)	IEEE 802.3af	
Power consumption (typical)	External power: 3.6 W at 12 VDC Power over Ethernet: 3.9 W	

¹ Use with external power only, not with PoE. See [I/Os and power supply by PoE](#) on page 50.

Table 28: Alvium G1-158m/c specifications (sheet 1 of 2)

Feature	Specification			
Storage temperature	-20 °C to +85 °C ambient temperature			
Operating temperature	Hardware option	Housing ²	Cooling area ³	Mainboard ⁴
	G1 BL No Mount ⁵	-20 °C to +65 °C	-20 °C to +85 °C	-20 °C to +85 °C
	G1 BL with mount ⁶	-20 °C to +65 °C	-20 °C to +85 °C	
Closed Housing	-20 °C to +65 °C	Not applicable		
Relative humidity	0% to 80% (non-condensing)			
Digital interface	1000BASE-T			
Camera controls	GenICam (GenICam Access)			

² Including the interface unit for G1 BL models

³ See [Heat dissipation for Alvium G1 BL](#) on page 192 and [Mounting the G1 BL interface unit](#) on page 201.

⁴ Output by DeviceTemperature

⁵ Ensure that the sensor is operated in the temperature range specified by the manufacturer. For any questions, please visit www.alliedvision.com/en/support.

Housing temperature applies to the interface unit only.

⁶ Temperature values must be observed for the housing **and** for the cooling areas.

Table 28: Alvium G1-158m/c specifications (sheet 2 of 2)

Absolute QE

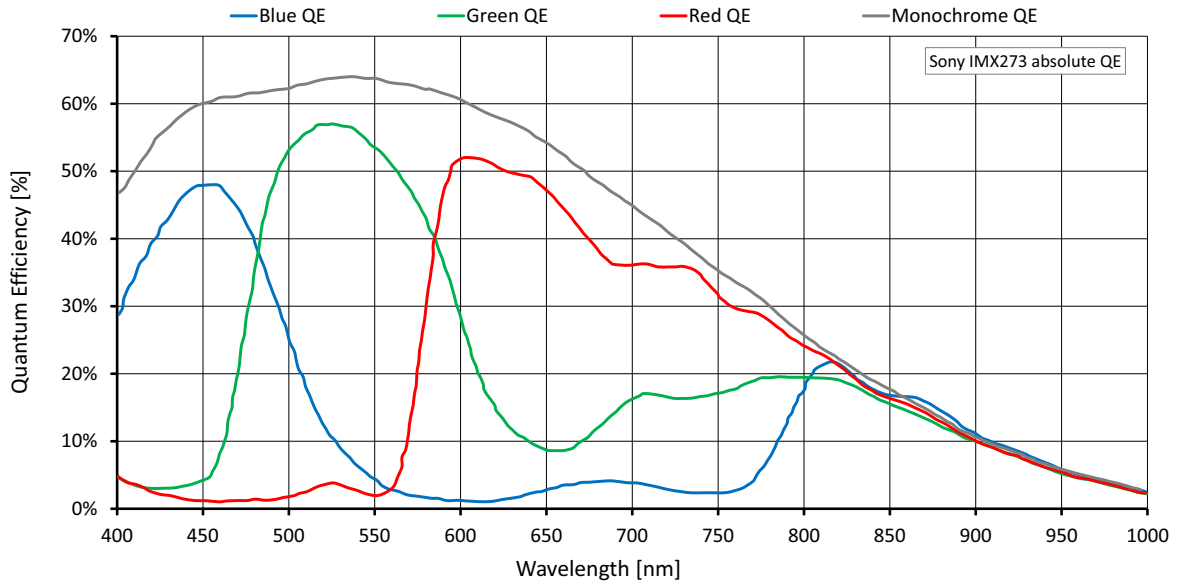

Figure 11: Alvium G1-158m/c (Sony IMX273) absolute QE

Spectral response

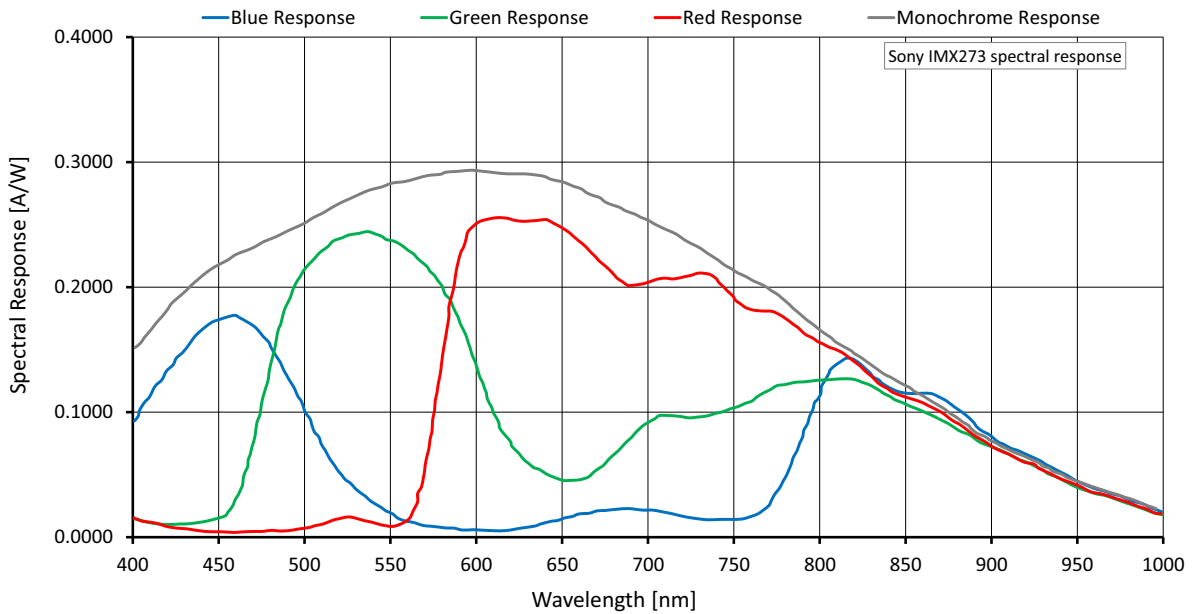

Figure 12: Alvium G1-158m/c (Sony IMX273) spectral response

ROI frame rates

Values are based on the conditions defined in [Specified values](#) on page 59.

Image format	Width [pixels]	Height [pixels]	ROI area [MP]	Frame rate [fps] ¹	
				122 MByte/s	12 MByte/s
Full resolution	1456	1088	1.584	74.7/37.4/37.3	7.3/3.7/3.7
WXGA+	1440	900	1.296	91.3/45.7/45.6	9.0/4.5/4.5
SXGA	1280	1024	1.311	90.3/45.1/45.2	8.9/4.4/4.4
HD 720	1280	720	0.922	128.4/64.2/64.2	12.6/6.3/6.3
XGA	1024	768	0.786	150.4/75.2/75.2	14.8/7.4/7.4
SVGA	800	600	0.48	246.3/123.2/123.3	24.2/12.1/12.1
VGA	640	480	0.307	384.8/192.4/192.4	37.9/18.9/18.9
HVGA	480	320	0.154	767.7/384.8/384.8	75.6/37.9/37.9
QVGA	320	240	0.077	1001.2/767.3/615.7	151.0/75.7/75.6
HQVGA	240	160	0.038	1351.0/1133.7/843.4	300.7/151.0/150.9
QQVGA	160	120	0.019	1636.9/1382.9/1031.8	596.1/300.7/300.3
Max. × half	1456	544	0.792	149.4/74.7/74.7	14.7/7.3/7.3
Max. × min.	1456	8	0.012	1941.9/1068.6/1038.7	970.9/493.2/492.7
Min. × max.	8	1088	0.009	267.4/219.1/161.2	
Min. × min.	8	8	0	4017.8/3647.7/2798.5	

¹ Mono8 or Bayer...8⁽²⁾ at SensorBitDepth = 8-Bit⁽³⁾ /
 Mono10 or Bayer...10 at SensorBitDepth = 10-Bit /
 Mono12 or Bayer...12 at SensorBitDepth = 12-Bit

² The three dots... represent the colors of a Bayer pixel format, such as in BayerRG8.

³ The SensorBitDepth value must be set separately from PixelFormat.
 See [Sensor ADC readout modes for maximum frame rates](#) on page 60 for details.

Table 29: Alvium G1-158m/c ROI frame rates

Alvium G1-192m/c (coming soon)

Feature	Specification	
	G1-192m (monochrome)	G1-192c (color)
Sensor model	e2v EV76C570 Sapphire	
Resolution	1600 (H) × 1200 (V); 1.92 MP	
Sensor type	CMOS	
Shutter type	Global shutter (GS)	
Sensor size	Type 1/1.8; 7.2 mm × 5.4 mm; 9.0 mm diagonal	
Pixel size	4.5 μm × 4.5 μm	
CRA	12 deg	
Sensor bit depth (ADC)	10-bit	
Monochrome pixel formats	Mono8 (default), Mono10, Mono10p, Mono12, Mono12p, Mono12Packed	Mono8, Mono10, Mono10p, Mono12, Mono12p, Mono12Packed
YUV color pixel formats	Not applicable	YCbCr411_8_CbYYCrYY, YCbCr422_8_CbYCrY, YCbCr8_CbYCr
RGB color pixel formats	Not applicable	BGR8, RGB8 (default)
Raw color pixel formats	Not applicable	BayerRG8, BayerRG10, BayerRG10p, BayerRG12, BayerRG12p, BayerRG12Packed
Maximum frame rate	59 fps (at 122 MByte/s)	
Exposure time	14 μs to 0.8 s (at 122 MByte/s)	
Exposure modes	Timed	
Gain	0 dB to 48 dB; 0.1 dB increments	
Digital binning	Horizontal: 1 to 8 columns; Vertical: 1 to 8 rows	
Image buffer (RAM)	32 MByte	
Non-volatile memory (Flash)	1024 KByte	
Inputs and outputs	1 opto-isolated input, 1 opto-isolated output, 2 non-isolated GPIOs ¹	
Power requirements	12 to 24 VDC	
Power requirements (PoE)	IEEE 802.3af	
Power consumption (typical)	External power: 2.3 W Power over Ethernet: 2.6 W	

¹ Use with external power only, not with PoE. See [I/Os and power supply by PoE](#) on page 50.

Table 30: Alvium G1-192m/c specifications (sheet 1 of 2)

Feature	Specification			
Storage temperature	-20 °C to +85 °C ambient temperature			
Operating temperature	Hardware option	Housing ²	Cooling area ³	Mainboard ⁴
	G1 BL No Mount ⁵	-20 °C to +65 °C	-20 °C to +85 °C	-20 °C to +85 °C
	G1 BL with mount ⁶	-20 °C to +65 °C	-20 °C to +85 °C	
Closed Housing	-20 °C to +65 °C	Not applicable		
Relative humidity	0% to 80% (non-condensing)			
Digital interface	1000BASE-T			
Camera controls	GenICam (GenICam Access)			

² Including the interface unit for G1 BL models

³ See [Heat dissipation for Alvium G1 BL](#) on page 192 and [Mounting the G1 BL interface unit](#) on page 201.

⁴ Output by `DeviceTemperature`

⁵ Ensure that the sensor is operated in the temperature range specified by the manufacturer. For any questions, please visit www.alliedvision.com/en/support.

Housing temperature applies to the interface unit only.

⁶ Temperature values must be observed for the housing **and** for the cooling areas.

Table 30: Alvium G1-192m/c specifications (sheet 2 of 2)

Absolute QE, spectral response

We intend to add diagrams in a future version of this document.

ROI frame rates

Values are based on the conditions defined in [Specified values](#) on page 59.

Image format	Width [pixels]	Height [pixels]	ROI area [MP]	Frame rate [fps] ¹	
				122 MByte/s	12 MByte/s
Full resolution, UXGA	1600	1200	1.920	59.5 / 31.2	6 / 3
WXGA+	1440	900	1.296	79.7 / 45.9	9 / 4
SXGA	1280	1024	1.311	70.2 / 45.5	9 / 4
HD 720	1280	720	0.922	99.0 / 64.1	12.8 / 6
XGA	1024	768	0.786	93.0 / 75.3	15.1 / 7
SVGA	800	600	0.480	118.0 / 118.0	24.5 / 12.2
VGA	640	480	0.307	146.2 / 146.2	37.9 / 18.9
HVGA	480	320	0.154	214.4 / 214.4	74.1 / 37.0
QVGA	320	240	0.077	279.6 / 279.6	144.9 / 72.5
HQVGA	240	160	0.038	401.8 / 401.8	277.7 / 138.9
QQVGA	160	120	0.019	514.2 / 514.2	514.2 / 266.6
Max. × half	1600	600	0.960	116.9 / 61.2	12.2 / 6
Max. × min.	1600	8	0.013	2348.9 / 1229.7	246.0 / 123.0
Min. × max.	8	1200	0.010	59.5 / 59.5	
Min. × min.	8	8	64 P	2371.9 / 2371.9	

¹ Mono8 or Bayer...8⁽²⁾ at `SensorBitDepth` = 10-Bit / Mono10 or Bayer...10 at `SensorBitDepth` = 10-Bit

² The three dots... represent the colors of a Bayer pixel format, such as in BayerRG8.

Table 31: Alvium G1-192m/c ROI frame rates (calculated values)

Alvium G1-234m/c

Feature	Specification	
	G1-234m (monochrome)	G1-234c (color)
Sensor model	Sony IMX249	
Resolution	1936 (H) × 1216 (V); 2.35 MP	
Sensor type	CMOS	
Shutter type	Global shutter (GS)	
Sensor size	Type 1/1.2; 11.3 mm × 7.1 mm; 13.4 mm diagonal	
Pixel size	5.86 μm × 5.86 μm	
CRA	0 deg	
Sensor bit depth (ADC)	10-bit, 12-bit; Adaptive (10-bit, 12-bit)	
Monochrome pixel formats	Mono8 (default), Mono10, Mono10p, Mono12, Mono12p, Mono12Packed	Mono8, Mono10, Mono10p, Mono12, Mono12p, Mono12Packed
YUV color pixel formats	Not applicable	YCbCr411_8_CbYYCrYY, YCbCr422_8_CbYCrY, YCbCr8_CbYCr
RGB color pixel formats	Not applicable	BGR8, RGB8 (default)
Raw color pixel formats	Not applicable	BayerRG8, BayerRG10, BayerRG10p, BayerRG12, BayerRG12p, BayerRG12Packed
Maximum frame rate	40 fps (at 122 MByte/s)	
Exposure time	34 μs to 10 s (at 122 MByte/s)	
Exposure modes	Timed	
Gain	0 dB to 48 dB; 0.1 dB increments	
Digital binning	Horizontal: 1 to 8 columns; Vertical: 1 to 8 rows	
Multiple ROI (H × V)	Free	
Image buffer (RAM)	32 MByte	
Non-volatile memory (Flash)	1024 KByte	
Inputs and outputs	1 opto-isolated input, 1 opto-isolated output, 2 non-isolated GPIOs ¹	
Power requirements	12 to 24 VDC	
Power requirements (PoE)	IEEE 802.3af	
Power consumption (typical)	External power: 3.0 W at 12 VDC Power over Ethernet: 3.3 W	

¹ Use with external power only, not with PoE. See [I/Os and power supply by PoE](#) on page 50.

Table 32: Alvium G1-234m/c specifications (sheet 1 of 2)

Feature	Specification			
	G1-234m (monochrome)		G1-234c (color)	
Storage temperature	-20 °C to +85 °C ambient temperature			
Operating temperature	Hardware option	Housing²	Cooling area³	Mainboard⁴
	G1 BL No Mount ⁵	-20 °C to +65 °C	-20 °C to +85 °C	-20 °C to +85 °C
	G1 BL with mount ⁶	-20 °C to +65 °C	-20 °C to +85 °C	
	Closed Housing	-20 °C to +65 °C	Not applicable	
Relative humidity	0% to 80% (non-condensing)			
Digital interface	1000BASE-T			
Camera controls	GenICam (GenICam Access)			
² Including the interface unit for G1 BL models ³ See Heat dissipation for Alvium G1 BL on page 192 and Mounting the G1 BL interface unit on page 201. ⁴ Output by DeviceTemperature ⁵ Ensure that the sensor is operated in the temperature range specified by the manufacturer. For any questions, please visit www.alliedvision.com/en/support . Housing temperature applies to the interface unit only. ⁶ Temperature values must be observed for the housing and for the cooling areas.				

Table 32: Alvium G1-234m/c specifications (sheet 2 of 2)

Absolute QE

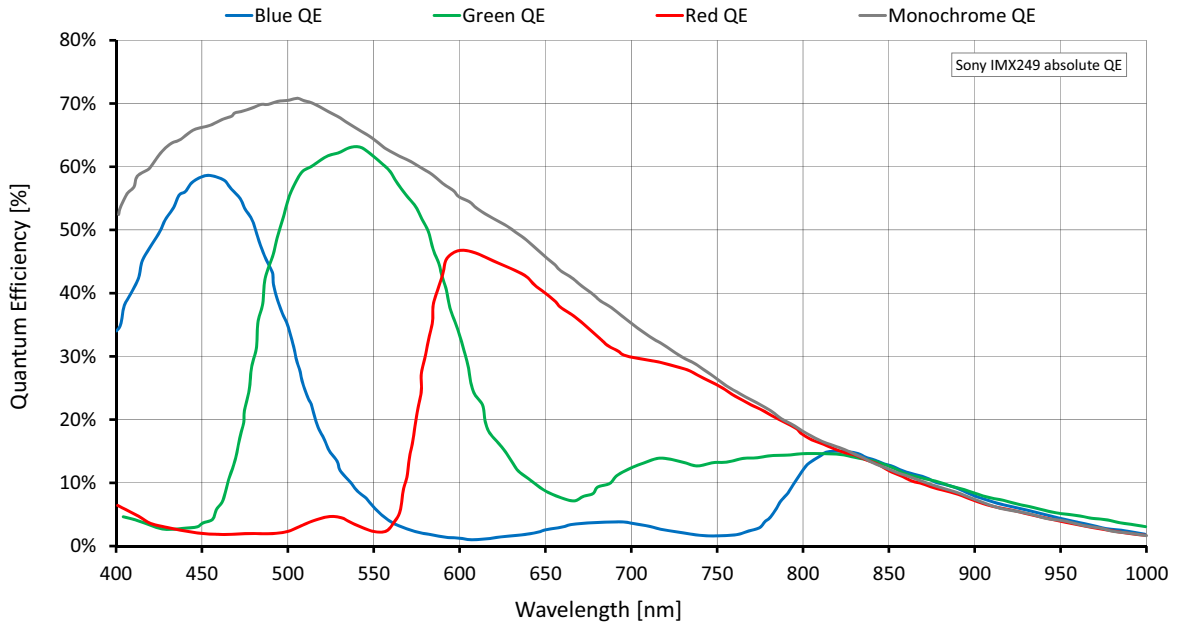

Figure 13: Alvium G1-234m/c (Sony IMX249) absolute QE

Spectral response

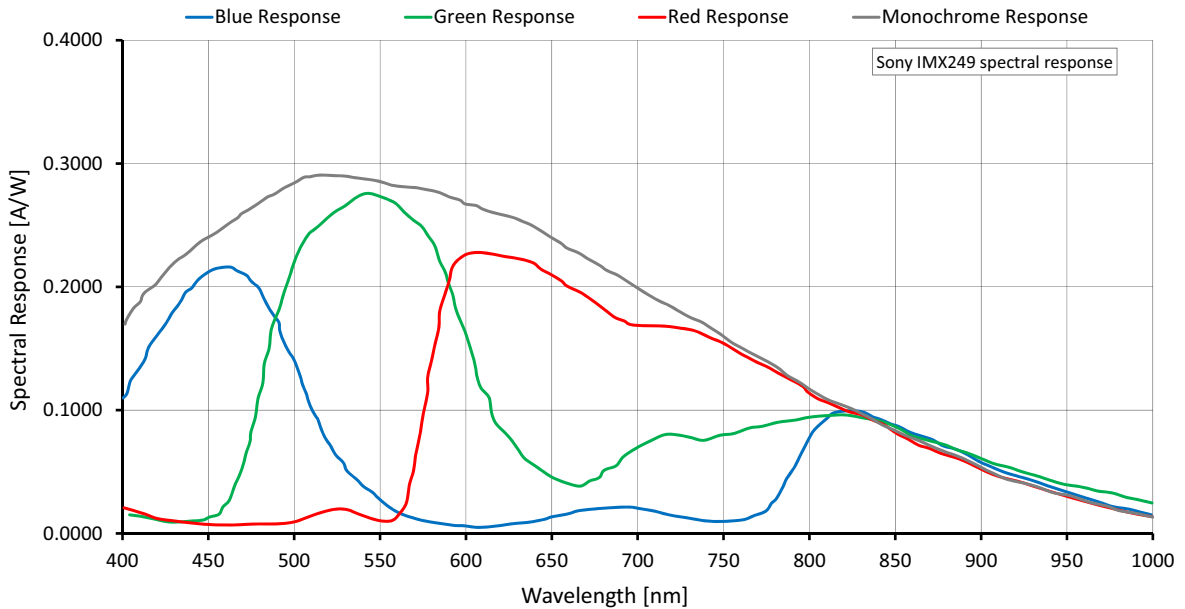

Figure 14: Alvium G1-234m/c (Sony IMX249) spectral response

ROI frame rates

Values are based on the conditions defined in [Specified values](#) on page 59.

Image format	Width [pixels]	Height [pixels]	ROI area [MP]	Frame rate [fps] ¹	
				122 MByte/s	12 MByte/s
Full resolution	1936	1216	2.354	40.5/25.1/25.1	4.9/2.5/2.5
Full HD	1920	1080	2.074	45.3/28.5/28.5	5.6/2.8/2.8
UXGA	1600	1200	1.92	41.0/30.8/30.8	6.1/3.0/3.0
WXGA+	1440	900	1.296	54.0/45.6/42.1	9.0/4.5/4.5
SXGA	1280	1024	1.311	47.8/45.2/37.2	8.9/4.4/4.4
HD 720	1280	720	0.922	66.6/64.1/51.9	12.6/6.3/6.3
XGA	1024	768	0.786	62.7/62.7/48.9	14.8/7.4/7.4
SVGA	800	600	0.48	79.1/79.1/61.6	24.2/12.1/12.1
VGA	640	480	0.307	97.0/96.9/75.6	37.8/18.9/18.9
HVGA	480	320	0.154	139.3/139.3/108.5	75.6/37.8/37.9
QVGA	320	240	0.077	177.8/177.8/138.6	150.7/75.6/75.6
HQVGA	240	160	0.038	245.9/245.9/192.5	245.9/150.7/150.6
QQVGA	160	120	0.019	305.9/305.9/238.4	305.9/300.5/238.4
Max. × half	1936	608	1.177	77.6/50.3/50.2	9.9/4.9/4.9
Max. × min.	1936	8	0.015	828.8/828.8/656.5	734.1/372.3/370.8
Min. × max.	8	1216	0.01	40.7/40.7/31.7	
Min. × min.	8	8	64 P	917.6/917.6/715.1	

¹ Mono8 or Mono10, or Bayer...8⁽²⁾ or Bayer...10 at **SensorBitDepth** = 10-Bit⁽³⁾ / Mono12 or Bayer...12 at **SensorBitDepth** = 12-Bit

² The three dots... represent the colors of a Bayer pixel format, such as in Bayer**RG8**.

³ The **SensorBitDepth** value must be set separately from **PixelFormat**. See [Sensor ADC readout modes for maximum frame rates](#) on page 60 for details.

Table 33: Alvium G1-234m/c ROI frame rates

Alvium G1-240m/c

Feature	Specification	
	G1-240m (monochrome)	G1-240c (color)
Sensor model	Sony IMX392	
Resolution	1936 (H) × 1216 (V); 2.4 MP	
Sensor type	CMOS	
Shutter type	Global shutter (GS)	
Sensor size	Type 1/2.3; 6.7 mm × 4.2 mm; 7.9 mm diagonal	
Pixel size	3.45 μm × 3.45 μm	
CRA	0 deg	
Sensor bit depth (ADC)	8-bit, 10-bit, 12-bit; Adaptive (10-bit, 12-bit)	
Monochrome pixel formats	Mono8 (default), Mono10, Mono10p, Mono12, Mono12p, Mono12Packed	Mono8, Mono10, Mono10p, Mono12, Mono12p, Mono12Packed
YUV color pixel formats	Not applicable	YCbCr411_8_CbYYCrYY, YCbCr422_8_CbYCrY, YCbCr8_CbYCr
RGB color pixel formats	Not applicable	BGR8, RGB8 (default)
Raw color pixel formats	Not applicable	BayerRG8, BayerRG10, BayerRG10p, BayerRG12, BayerRG12p, BayerRG12Packed
Maximum frame rate	50 fps (at 122 MByte/s)	
Exposure time	30 μs to 10 s (at 122 MByte/s)	
Exposure modes	Timed, TriggerControlled, TriggerWidth	
Gain	0 dB to 48 dB; 0.1 dB increments	
Digital binning	Horizontal: 1 to 8 columns; Vertical: 1 to 8 rows	
Sensor binning (H × V)	2 × 2 (<i>Sum</i>)	Not applicable
Multiple ROI (H × V)	<i>Free Tile</i>	
Image buffer (RAM)	32 MByte	
Non-volatile memory (Flash)	1024 KByte	
Inputs and outputs	1 opto-isolated input, 1 opto-isolated output, 2 non-isolated GPIOs ¹	
Power requirements	12 to 24 VDC	
Power requirements (PoE)	IEEE 802.3af	
Power consumption (typical)	External power: 3.6 W at 12 VDC Power over Ethernet: 4.0 W	

¹ Use with external power only, not with PoE. See [I/Os and power supply by PoE](#) on page 50.

Table 34: Alvium G1-240m/c specifications (sheet 1 of 2)

Feature	Specification			
Storage temperature	-20 °C to +85 °C ambient temperature			
Operating temperature	Hardware option	Housing ²	Cooling area ³	Mainboard ⁴
	G1 BL No Mount ⁵	-20 °C to +65 °C	-20 °C to +85 °C	-20 °C to +85 °C
	G1 BL with mount ⁶	-20 °C to +65 °C	-20 °C to +85 °C	
Closed Housing	-20 °C to +65 °C	Not applicable		
Relative humidity	0% to 80% (non-condensing)			
Digital interface	1000BASE-T			
Camera controls	GenICam (GenICam Access)			

² Including the interface unit for G1 BL models

³ See [Heat dissipation for Alvium G1 BL](#) on page 192 and [Mounting the G1 BL interface unit](#) on page 201.

⁴ Output by DeviceTemperature

⁵ Ensure that the sensor is operated in the temperature range specified by the manufacturer. For any questions, please visit www.alliedvision.com/en/support.

Housing temperature applies to the interface unit only.

⁶ Temperature values must be observed for the housing **and** for the cooling areas.

Table 34: Alvium G1-240m/c specifications (sheet 2 of 2)

Absolute QE

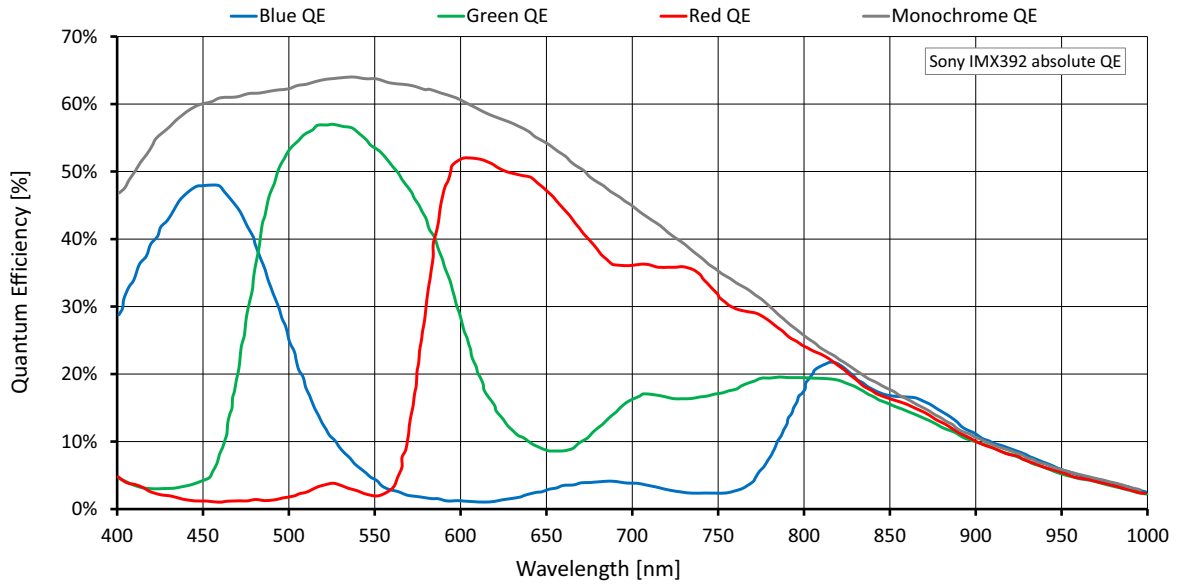

Figure 15: Alvium G1-240m/c (Sony IMX392) absolute QE

Spectral response

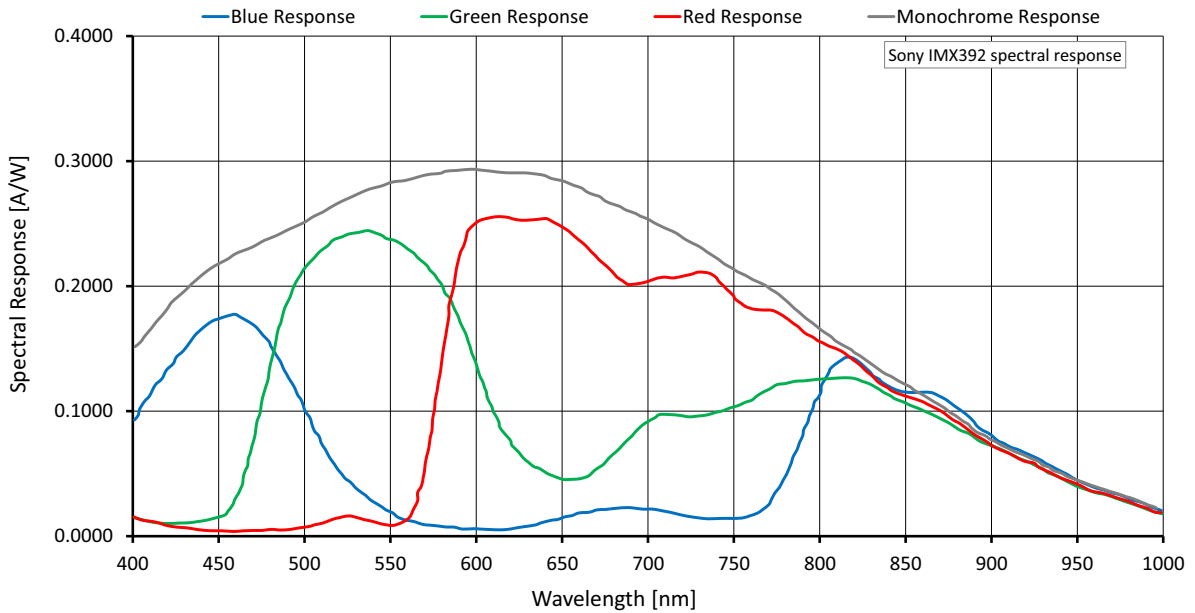

Figure 16: Alvium G1-240m/c (Sony IMX392) spectral response

ROI frame rates

Values are based on the conditions defined in [Specified values](#) on page 59.

Image format	Width [pixels]	Height [pixels]	ROI area [MP]	Frame rate [fps] ¹	
				122 MByte/s	12 MByte/s
Full resolution	1936	1216	2.354	50.3/25.1/25.1	4.9/2.5/2.5
Full HD	1920	1080	2.074	57.1/28.5/28.5	5.6/2.8/2.8
UXGA	1600	1200	1.92	61.6/30.8/30.8	6.1/3.0/3.0
WXGA+	1440	900	1.296	91.3/45.7/45.6	9.0/4.5/4.5
SXGA	1280	1024	1.311	90.3/45.1/45.2	8.9/4.4/4.4
HD 720	1280	720	0.922	128.4/64.2/64.2	12.6/6.3/6.3
XGA	1024	768	0.786	150.4/75.2/75.2	14.8/7.4/7.4
SVGA	800	600	0.48	246.4/123.2/123.3	24.2/12.1/12.1
VGA	640	480	0.307	384.7/192.4/192.4	37.9/18.9/18.9
HVGA	480	320	0.154	658.4/384.8/384.4	75.7/37.9/37.9
QVGA	320	240	0.077	833.4/701.5/574.7	151.0/75.6/75.6
HQVGA	240	160	0.038	1135.0/968.3/796.3	300.8/151.0/150.9
QQVGA	160	120	0.019	1385.9/1192.2/983.7	595.8/300.7/300.8
Max. x half	1936	608	1.177	100.5/50.2/50.2	9.9/4.9/4.9
Max. x min.	1936	8	0.015	1537.2/888.9/876.2	739.1/370.4/370.7
Min. x max.	8	1216	0.01	196.4/162.5/132.1	
Min. x min.	8	8	64 P	3635.4/3381.1/2883.2	

¹ Mono8 or Bayer...8⁽²⁾ at SensorBitDepth = 8-Bit⁽³⁾ /
 Mono10 or Bayer...10 at SensorBitDepth = 10-Bit /
 Mono12 or Bayer...12 at SensorBitDepth = 12-Bit

² The three dots... represent the colors of a Bayer pixel format, such as in BayerRG8.

³ The SensorBitDepth value must be set separately from PixelFormat.
 See [Sensor ADC readout modes for maximum frame rates](#) on page 60 for details.

Table 35: Alvium G1-240m/c ROI frame rates

Alvium G1-319m/c

Feature	Specification	
	G1-319m (monochrome)	G1-319c (color)
Sensor model	Sony IMX265	
Resolution	2064 (H) × 1544 (V); 3.2 MP	
Sensor type	CMOS	
Shutter type	Global shutter (GS)	
Sensor size	Type 1/1.8; 7.1 mm × 5.3 mm; 8.9 mm diagonal	
Pixel size	3.45 μm × 3.45 μm	
CRA	0 deg	
Sensor bit depth (ADC)	12-bit	
Monochrome pixel formats	Mono8 (default), Mono10, Mono10p, Mono12, Mono12p, Mono12Packed	Mono8, Mono10, Mono10p, Mono12, Mono12p, Mono12Packed
YUV color pixel formats	Not applicable	YCbCr411_8_CbYYCrYY, YCbCr422_8_CbYCrY, YCbCr8_CbYCr
RGB color pixel formats	Not applicable	BGR8, RGB8 (default)
Raw color pixel formats	Not applicable	BayerRG8, BayerRG10, BayerRG10p, BayerRG12, BayerRG12p, BayerRG12Packed
Maximum frame rate	37 fps (at 122 MByte/s)	
Exposure time	31 μs to 10 s (at 122 MByte/s)	
Exposure modes	Timed, TriggerControlled, TriggerWidth	
Gain	0 dB to 48 dB; 0.1 dB increments	
Digital binning	Horizontal: 1 to 8 columns; Vertical: 1 to 8 rows	
Multiple ROI (H × V)	<i>Free</i>	
Image buffer (RAM)	32 MByte	
Non-volatile memory (Flash)	1024 KByte	
Inputs and outputs	1 opto-isolated input, 1 opto-isolated output, 2 non-isolated GPIOs ¹	
Power requirements	12 to 24 VDC	
Power requirements (PoE)	IEEE 802.3af	
Power consumption (typical)	External power: 3.0 W at 12 VDC Power over Ethernet: 3.3 W	

¹ Use with external power only, not with PoE. See [I/Os and power supply by PoE](#) on page 50.

Table 36: Alvium G1-319m/c specifications (sheet 1 of 2)

Feature	Specification			
Storage temperature	-20 °C to +85 °C ambient temperature			
Operating temperature	Hardware option	Housing ²	Cooling area ³	Mainboard ⁴
	G1 BL No Mount ⁵	-20 °C to +65 °C	-20 °C to +85 °C	-20 °C to +85 °C
	G1 BL with mount ⁶	-20 °C to +65 °C	-20 °C to +85 °C	
Closed Housing	-20 °C to +65 °C	Not applicable		
Relative humidity	0% to 80% (non-condensing)			
Digital interface	1000BASE-T			
Camera controls	GenICam (GenICam Access)			

² Including the interface unit for G1 BL models

³ See [Heat dissipation for Alvium G1 BL](#) on page 192 and [Mounting the G1 BL interface unit](#) on page 201.

⁴ Output by DeviceTemperature

⁵ Ensure that the sensor is operated in the temperature range specified by the manufacturer. For any questions, please visit www.alliedvision.com/en/support.

Housing temperature applies to the interface unit only.

⁶ Temperature values must be observed for the housing **and** for the cooling areas.

Table 36: Alvium G1-319m/c specifications (sheet 2 of 2)

Absolute QE

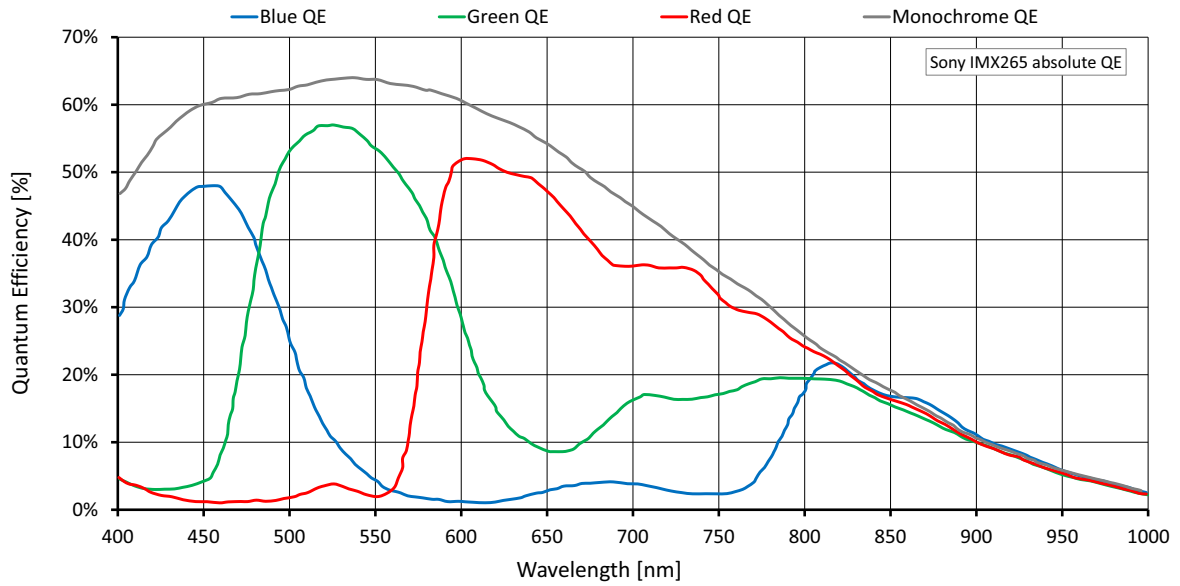

Figure 17: Alvium G1-319m/c (Sony IMX265) absolute QE

Spectral response

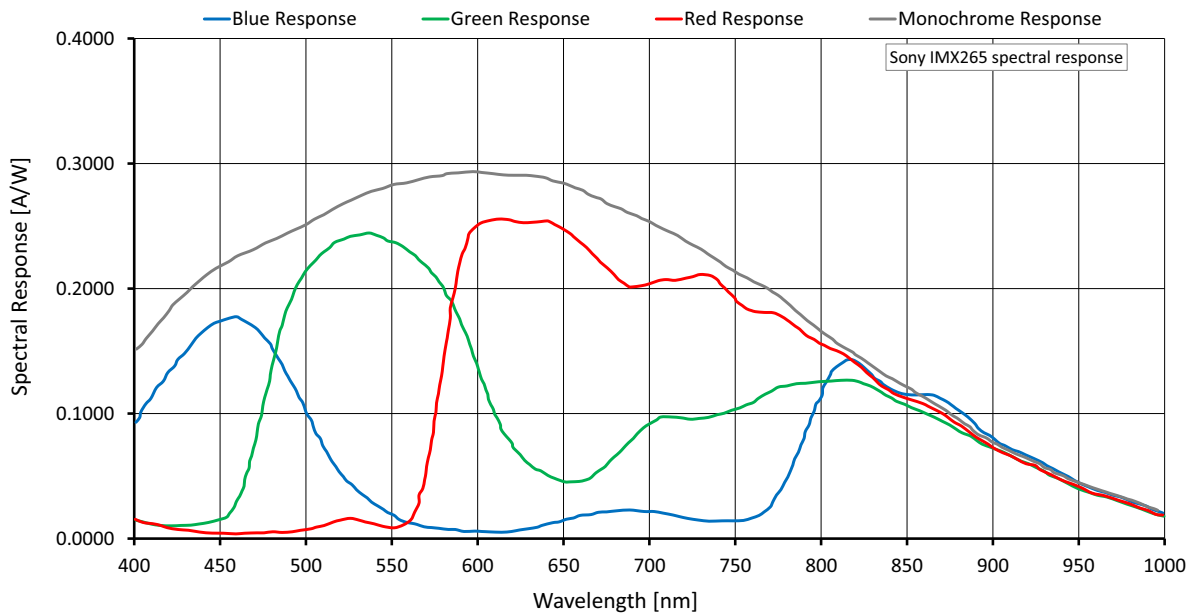

Figure 18: Alvium G1-319m/c (Sony IMX265) spectral response

ROI frame rates

Values are based on the conditions defined in [Specified values](#) on page 59.

Image format	Width [pixels]	Height [pixels]	ROI area [MP]	Frame rate [fps] ¹	
				122 MByte/s	12 MByte/s
Full resolution	2064	1544	3.187	37.1/18.6	3.7/1.8
QXGA	2048	1536	3.146	37.6/18.8	3.7/1.9
Full HD	1920	1080	2.074	57.1/28.5	5.6/2.8
UXGA	1600	1200	1.92	61.6/30.8	6.1/3.0
WXGA+	1440	900	1.296	90.8/45.6	9.0/4.5
SXGA	1280	1024	1.311	80.5/45.2	8.9/4.4
HD 720	1280	720	0.922	112.0/64.2	12.6/6.3
XGA	1024	768	0.786	105.8/75.2	14.8/7.4
SVGA	800	600	0.48	133.3/123.3	24.2/12.1
VGA	640	480	0.307	163.8/163.8	37.9/18.9
HVGA	480	320	0.154	234.9/234.9	75.6/37.9
QVGA	320	240	0.077	301.5/301.5	150.8/75.6
HQVGA	240	160	0.038	419.0/417.0	300.5/150.8
QQVGA	160	120	0.019	518.7/515.7	518.7/300.5
Max. × half	2064	772	1.593	74.2/37.1	7.3/3.7
Max. × min.	2064	8	0.017	1193.8/810.1	691.6/347.9
Min. × max.	8	1544	0.012	54.7/54.7	
Min. × min.	8	8	64 P	1556.2/1528.9	

¹ Mono8 or Bayer...8⁽²⁾ at SensorBitDepth = 12-Bit / Mono12 or Bayer...12 at SensorBitDepth = 12-Bit

² The three dots... represent the colors of a Bayer pixel format, such as in Bayer**RG8**.

Table 37: Alvium G1-319m/c ROI frame rates

Alvium G1-500m/c

Feature	Specification	
	G1-500m (monochrome)	G1-500c (color)
Sensor model	ON Semiconductor AR0521SR	
Resolution	2592 (H) × 1944 (V); 5.0 MP	
Sensor type	CMOS	
Shutter type	Rolling shutter (RS)	
Sensor size	Type 1/2.5; 5.7 mm × 4.3 mm; 7.1 mm diagonal	
Pixel size	2.2 μm × 2.2 μm	
CRA	9 deg	
Sensor bit depth (ADC)	10-bit	
Monochrome pixel formats	Mono8 (default), Mono10, Mono10p, Mono12, Mono12p, Mono12Packed	Mono8, Mono10, Mono10p, Mono12, Mono12p, Mono12Packed
YUV color pixel formats	Not applicable	YCbCr411_8_CbYYCrYY, YCbCr422_8_CbYCrY, YCbCr8_CbYCr
RGB color pixel formats	Not applicable	BGR8, RGB8 (default)
Raw color pixel formats	Not applicable	BayerGR8, BayerGR10, BayerGR10p, BayerGR12, BayerGR12p, BayerGR12Packed
Maximum frame rate	23 fps (at 122 MByte/s)	
Exposure time	22 μs to 10 s (at 122 MByte/s)	
Exposure modes	Timed	
Gain	0 dB to 24.1 dB; 0.1 dB increments	
Digital binning	Horizontal: 1 to 8 columns; Vertical: 1 to 8 rows	
Sensor binning (H × V)	2 × 1, 4 × 1 (<i>Sum</i>)	
Image buffer (RAM)	32 MByte	
Non-volatile memory (Flash)	1024 KByte	
Inputs and outputs	1 opto-isolated input, 1 opto-isolated output, 2 non-isolated GPIOs ²	
Power requirements	12 to 24 VDC	
Power requirements (PoE)	IEEE 802.3af	
¹ In triggered mode: ~11 fps ² Use with external power only, not with PoE. See I/Os and power supply by PoE on page 50.		

Table 38: Alvium G1-500m/c specifications (sheet 1 of 2)

Feature	Specification			
Power consumption (typical)	External power: 2.9 W at 12 VDC Power over Ethernet: 3.2 W			
Storage temperature	-20 °C to +85 °C ambient temperature			
Operating temperature	Hardware option	Housing³	Cooling area⁴	Mainboard⁵
	G1 BL No Mount ⁶	-20 °C to +65 °C	-20 °C to +85 °C	-20 °C to +85 °C
	G1 BL with mount ⁷	-20 °C to +65 °C	-20 °C to +85 °C	
	Closed Housing	-20 °C to +65 °C	Not applicable	
Relative humidity	0% to 80% (non-condensing)			
Digital interface	1000BASE-T			
Camera controls	GenICam (GenICam Access)			

³ Including the interface unit for G1 BL models

⁴ See [Heat dissipation for Alvium G1 BL](#) on page 192 and [Mounting the G1 BL interface unit](#) on page 201.

⁵ Output by DeviceTemperature

⁶ Ensure that the sensor is operated in the temperature range specified by the manufacturer. For any questions, please visit www.alliedvision.com/en/support.

Housing temperature applies to the interface unit only.

⁷ Temperature values must be observed for the housing **and** for the cooling areas.

Table 38: Alvium G1-500m/c specifications (sheet 2 of 2)

Absolute QE

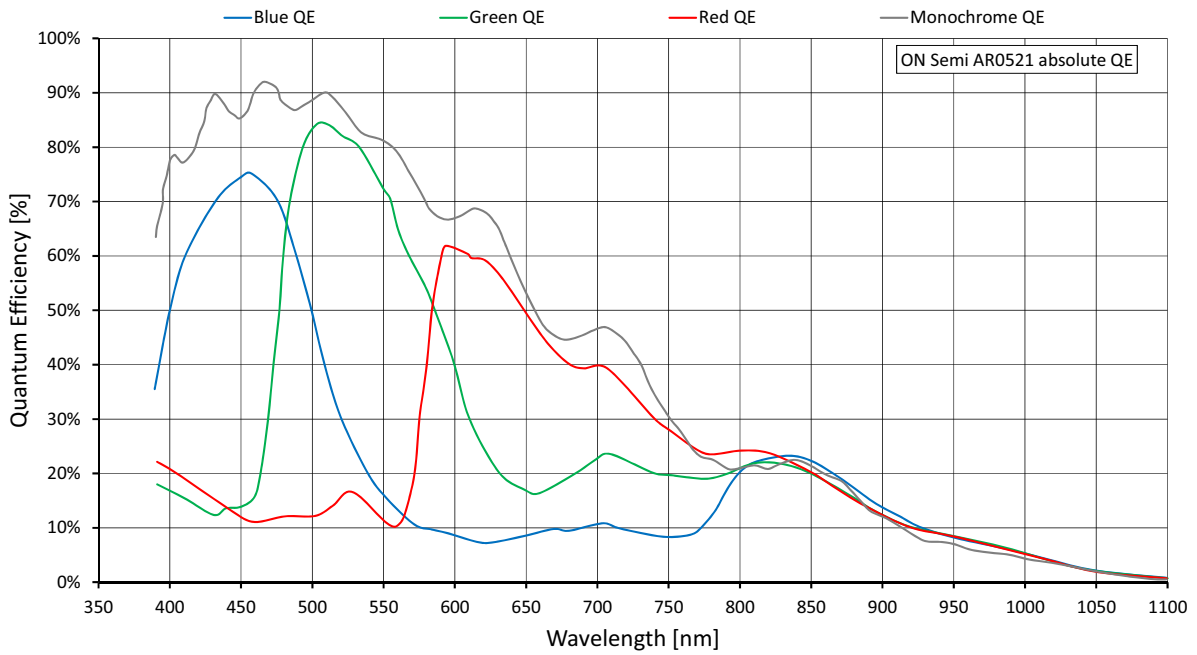

Figure 19: Alvium G1-500m/c (ON Semi AR0521) absolute QE

Spectral response

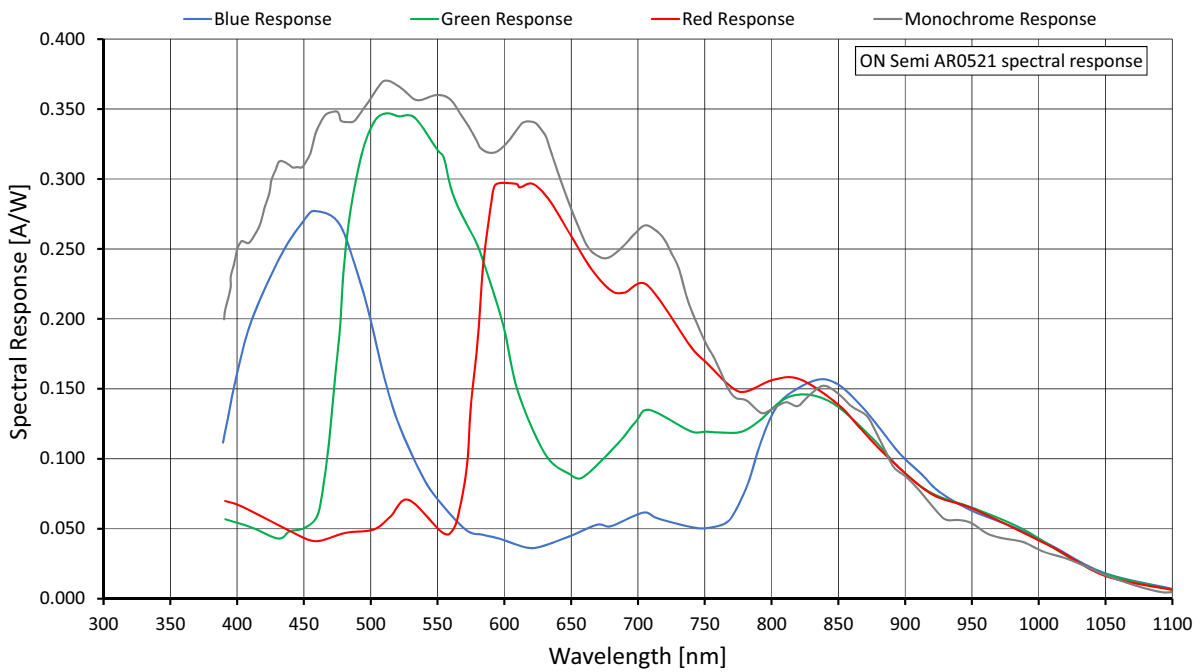

Figure 20: Alvium G1-500m/c (ON Semi AR0521) spectral response

ROI frame rates

Values are based on the conditions defined in [Specified values](#) on page 59.

Shutter mode	User mode	Available frame rates
Rolling shutter (RS)	Freerun	Values in Table 40 below are reached.
Rolling shutter (RS)	Triggered	>50% of the values for in Table 40 below are reached.

Table 39: Frame rate behavior for different configurations

Currently, Alvium G1-500 models can be operated only at 122 MByte/s.

Image format	Width [pixels]	Height [pixels]	ROI area [MP]	Frame rate [fps] ¹
				122 MByte/s
Full resolution	2592	1944	5.039	23.5/11.7
WQHD	2560	1440	3.686	32.1/16.1
QXGA	2048	1536	3.146	37.6/18.8
Full HD	1920	1080	2.074	57.1/28.5
UXGA	1600	1200	1.92	61.6/30.8
WXGA+	1440	900	1.296	91.3/45.7
SXGA	1280	1024	1.311	90.2/45.1
HD 720	1280	720	0.922	128.3/64.2
XGA	1024	768	0.786	150.3/75.2
SVGA	800	600	0.48	212.1/123.2
VGA	640	480	0.307	261.4/192.3
HVGA	480	320	0.154	378.2/378.2
QVGA	320	240	0.077	489.7/489.7
HQVGA	240	160	0.038	687.6/687.6
QQVGA	160	120	0.019	861.5/861.5
Max. × half	2592	972	2.519	47.0/23.5
Max. × min.	2592	8	0.021	1544.1/865.4
Min. × max.	8	1944	0.016	68.7/68.7
Min. × min.	8	8	64 P	2956.0/2956.0

¹ Mono8 or Bayer...8⁽²⁾ at SensorBitDepth = 10-Bit /
Mono10 or Bayer...10 at SensorBitDepth = 10-Bit

² The three dots... represent the colors of a Bayer pixel format, such as in BayerRG8.

Table 40: Alvium G1-500m/c ROI frame rates

Alvium G1-507m/c

Feature	Specification	
	G1-507m (monochrome)	G1-507c (color)
Sensor model	Sony IMX264	
Resolution	2464 (H) × 2056 (V); 5.1 MP	
Sensor type	CMOS	
Shutter type	Global shutter (GS)	
Sensor size	Type 2/3; 8.5 mm × 7.1 mm; 11.1 mm diagonal	
Pixel size	3.45 μm × 3.45 μm	
CRA	0 deg	
Sensor bit depth (ADC)	12-bit	
Monochrome pixel formats	Mono8 (default), Mono10, Mono10p, Mono12, Mono12p, Mono12Packed	Mono8, Mono10, Mono10p, Mono12, Mono12p, Mono12Packed
YUV color pixel formats	Not applicable	YCbCr411_8_CbYYCrYY, YCbCr422_8_CbYCrY, YCbCr8_CbYCr
RGB color pixel formats	Not applicable	BGR8, RGB8 (default)
Raw color pixel formats	Not applicable	BayerRG8, BayerRG10, BayerRG10p, BayerRG12, BayerRG12p, BayerRG12Packed
Maximum frame rate	23 fps (at 122 MByte/s)	
Exposure time	34 μs to 10 s (at 122 MByte/s)	
Exposure modes	Timed, TriggerControlled, TriggerWidth	
Gain	0 dB to 48 dB; 0.1 dB increments	
Digital binning	Horizontal: 1 to 8 columns; Vertical: 1 to 8 rows	
Multiple ROI (H × V)	<i>Free</i>	
Image buffer (RAM)	32 MByte	
Non-volatile memory (Flash)	1024 KByte	
Inputs and outputs	1 opto-isolated input, 1 opto-isolated output, 2 non-isolated GPIOs ¹	
Power requirements	12 to 24 VDC	
Power requirements (PoE)	IEEE 802.3af	
Power consumption (typical)	External power: 3.1 W at 12 VDC Power over Ethernet: 3.4 W	

¹ Use with external power only, not with PoE. See [I/Os and power supply by PoE](#) on page 50.

Table 41: Alvium G1-507m/c specifications (sheet 1 of 2)

Feature	Specification			
Storage temperature	-20 °C to +85 °C ambient temperature			
Operating temperature	Hardware option	Housing ²	Cooling area ³	Mainboard ⁴
	G1 BL No Mount ⁵	-20 °C to +65 °C	-20 °C to +85 °C	-20 °C to +85 °C
	G1 BL with mount ⁶	-20 °C to +65 °C	-20 °C to +85 °C	
Closed Housing	-20 °C to +65 °C	Not applicable		
Relative humidity	0% to 80% (non-condensing)			
Digital interface	1000BASE-T			
Camera controls	GenICam (GenICam Access)			
² Including the interface unit for G1 BL models ³ See Heat dissipation for Alvium G1 BL on page 192 and Mounting the G1 BL interface unit on page 201. ⁴ Output by DeviceTemperature ⁵ Ensure that the sensor is operated in the temperature range specified by the manufacturer. For any questions, please visit www.alliedvision.com/en/support . Housing temperature applies to the interface unit only. ⁶ Temperature values must be observed for the housing and for the cooling areas.				

Table 41: Alvium G1-507m/c specifications (sheet 2 of 2)

Absolute QE

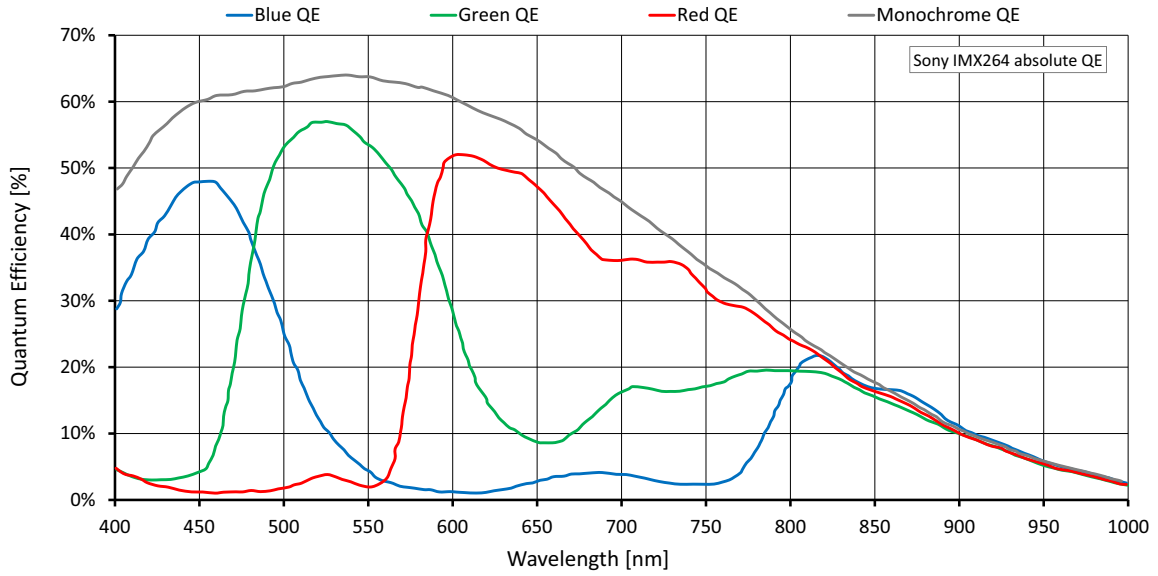

Figure 21: Alvium G1-507m/c (Sony IMX264) absolute QE

Spectral response

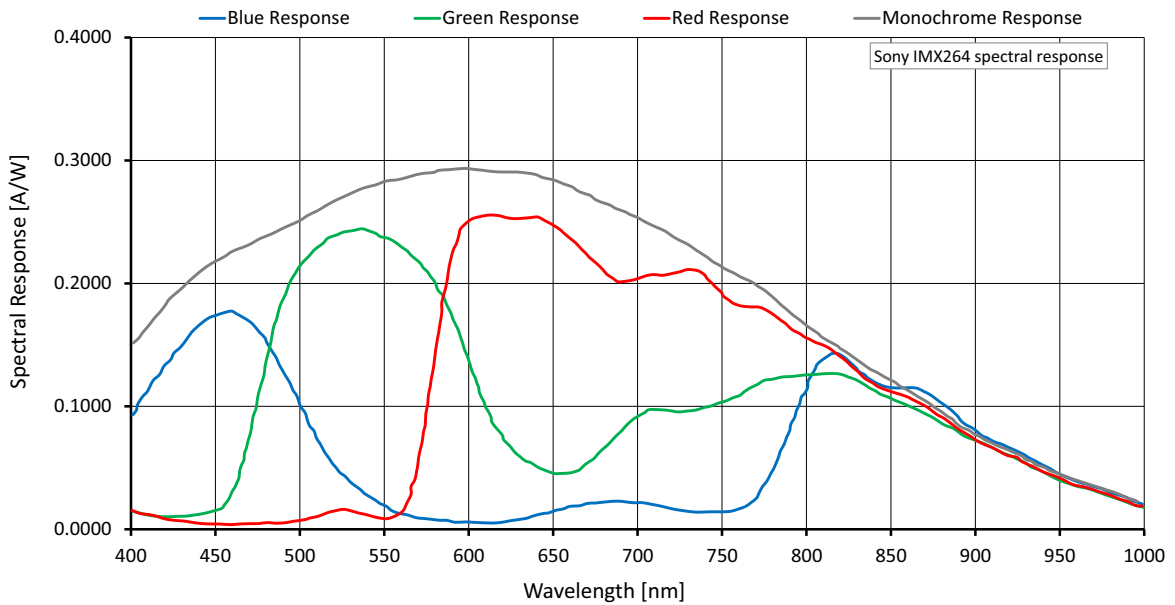

Figure 22: Alvium G1-507m/c (Sony IMX264) spectral response

ROI frame rates

Values are based on the conditions defined in [Specified values](#) on page 59.

Image format	Width [pixels]	Height [pixels]	ROI area [MP]	Frame rate [fps] ¹	
				122 MByte/s	12 MByte/s
Full resolution	2464	2056	5.066	23.4/11.7	2.3/1.1
QXGA	2048	1536	3.146	37.6/18.8	3.7/1.9
Full HD	1920	1080	2.074	57.0/28.5	5.6/2.8
UXGA	1600	1200	1.92	58.9/30.8	6.1/3.0
WXGA+	1440	900	1.296	77.3/45.7	9.0/4.5
SXGA	1280	1024	1.311	68.6/45.2	8.9/4.4
HD 720	1280	720	0.922	95.5/64.2	12.6/6.3
XGA	1024	768	0.786	90.1/75.2	14.8/7.4
SVGA	800	600	0.48	113.7/113.5	24.2/12.1
VGA	640	480	0.307	139.6/139.6	37.8/18.9
HVGA	480	320	0.154	200.3/200.3	75.6/37.8
QVGA	320	240	0.077	256.4/256.4	150.9/75.6
HQVGA	240	160	0.038	356.3/356.3	300.0/150.9
QQVGA	160	120	0.019	441.1/441.1	441.1/300.0
Max. × half	2464	1028	2.533	46.7/23.4	4.6/2.3
Max. × min.	2464	8	0.02	1015.1/689.3	578.9/291.6
Min. × max.	8	2056	0.016	35.2/35.2	
Min. × min.	8	8	64 P	1323.2/1323.2	

¹ Mono8 or Bayer...8⁽²⁾ at SensorBitDepth = 12-Bit/
Mono12 or Bayer...12 at SensorBitDepth = 12-Bit

² The three dots... represent the colors of a Bayer pixel format, such as in BayerRG8.

Table 42: Alvium G1-507m/c ROI frame rates

Alvium G1-507m/c Pol (coming soon)



Please observe

For first series models, pixel processing has not been adjusted to enable the complete functionality available with non-polarizer models:

- Only raw pixel formats are supported, but no formats for polarizer sensors.
- Features based on pixel processing are available but cannot be used to generate a proper output. For example, color processing, binning, convolution filter, DPC, or FPNC are not supported.

Feature	Specification	
	G1-507m Pol (monochrome)	G1-507c Pol (color)
Sensor model	Sony IMX264MZR	Sony IMX264MYR
Resolution	2464 (H) × 2056 (V); 5.1 MP	
Sensor type	CMOS	
Shutter type	Global shutter (GS)	
Sensor size	Type 2/3; 8.5 mm × 7.1 mm; 11.1 mm diagonal	
Pixel size	3.45 μm × 3.45 μm	
CRA	0 deg	
Sensor bit depth (ADC)	12-bit	
Monochrome pixel formats	Mono8 (default), Mono10, Mono10p, Mono12, Mono12p, Mono12Packed	Not applicable
Raw color pixel formats	Not applicable	BayerRG8, BayerRG10, BayerRG10p, BayerRG12, BayerRG12p, BayerRG12Packed
Maximum frame rate	23 fps (at 122 MByte/s)	
Exposure time	34 μs to 10 s (at 122 MByte/s)	
Exposure modes	Timed, TriggerControlled, TriggerWidth	
Gain	0 dB to 48 dB; 0.1 dB increments	
Multiple ROI (H × V)	<i>Free</i>	
Image buffer (RAM)	32 MByte	
Non-volatile memory (Flash)	1024 KByte	
Inputs and outputs	1 opto-isolated input, 1 opto-isolated output, 2 non-isolated GPIOs ¹	
Power requirements	12 to 24 VDC	
Power requirements (PoE)	IEEE 802.3af	
Power consumption (typical)	External power: 3.1 W at 12 VDC Power over Ethernet: 3.4 W	

¹ Use with external power only, not with PoE. See [I/Os and power supply by PoE](#) on page 50.

Table 43: Alvium G1-507m/c Pol specifications (sheet 1 of 2)

Feature	Specification			
Storage temperature	-20 °C to +85 °C ambient temperature			
Operating temperature	Hardware option	Housing²	Cooling area³	Mainboard⁴
	G1 BL No Mount ⁵	-20 °C to +65 °C	-20 °C to +85 °C	-20 °C to +85 °C
	G1 BL with mount ⁶	-20 °C to +65 °C	-20 °C to +85 °C	
	Closed Housing	-20 °C to +65 °C	Not applicable	
Relative humidity	0% to 80% (non-condensing)			
Digital interface	1000BASE-T			
Camera controls	GenICam (GenICam Access)			

² Including the interface unit for G1 BL models

³ See [Heat dissipation for Alvium G1 BL](#) on page 192 and [Mounting the G1 BL interface unit](#) on page 201.

⁴ Output by DeviceTemperature

⁵ Ensure that the sensor is operated in the temperature range specified by the manufacturer. For any questions, please visit www.alliedvision.com/en/support.

Housing temperature applies to the interface unit only.

⁶ Temperature values must be observed for the housing **and** for the cooling areas.

Table 43: Alvium G1-507m/c Pol specifications (sheet 2 of 2)

Absolute QE, spectral response

We intend to add diagrams in a future version of this document.

ROI frame rates

Values are based on the conditions defined in [Specified values](#) on page 59.

Image format	Width [pixels]	Height [pixels]	ROI area [MP]	Frame rate [fps] ¹	
				122 MByte/s	12 MByte/s
Full resolution	2464	2056	5.066	23.4/11.7	2.3/1.1
QXGA	2048	1536	3.146	37.6/18.8	3.7/1.9
Full HD	1920	1080	2.074	57.0/28.5	5.6/2.8
UXGA	1600	1200	1.92	58.9/30.8	6.1/3.0
WXGA+	1440	900	1.296	77.3/45.7	9.0/4.5
SXGA	1280	1024	1.311	68.6/45.2	8.9/4.4
HD 720	1280	720	0.922	95.5/64.2	12.6/6.3
XGA	1024	768	0.786	90.1/75.2	14.8/7.4
SVGA	800	600	0.48	113.7/113.5	24.2/12.1
VGA	640	480	0.307	139.6/139.6	37.8/18.9
HVGA	480	320	0.154	200.3/200.3	75.6/37.8
QVGA	320	240	0.077	256.4/256.4	150.9/75.6
HQVGA	240	160	0.038	356.3/356.3	300.0/150.9
QQVGA	160	120	0.019	441.1/441.1	441.1/300.0
Max. × half	2464	1028	2.533	46.7/23.4	4.6/2.3
Max. × min.	2464	8	0.02	1015.1/689.3	578.9/291.6
Min. × max.	8	2056	0.016	35.2/35.2	
Min. × min.	8	8	64 P	1323.2/1323.2	

¹ Mono8 or Bayer...8⁽²⁾ at SensorBitDepth = 12-Bit/
Mono12 or Bayer...12 at SensorBitDepth = 12-Bit

² The three dots... represent the colors of a Bayer pixel format, such as in BayerRG8.

Table 44: Alvium G1-507m/c Pol ROI frame rates

Alvium G1-510m/c

Feature	Specification	
	G1-510m (monochrome)	G1-510c (color)
Sensor model	Sony IMX548	
Resolution	2464 (H) × 2064 (V); 5.1 MP	
Sensor type	CMOS	
Shutter type	Global shutter (GS)	
Sensor size	Type 1/1.8; 6.8 mm × 5.7 mm; 8.8 mm diagonal	
Pixel size	2.74 μm × 2.74 μm	
CRA	0 deg	
Sensor bit depth (ADC)	12-bit	
Monochrome pixel formats	Mono8 (default), Mono10, Mono10p, Mono12, Mono12p, Mono12Packed	Mono8, Mono10, Mono10p, Mono12, Mono12p, Mono12Packed
YUV color pixel formats	Not applicable	YCbCr411_8_CbYYCrYY, YCbCr422_8_CbYCrY, YCbCr8_CbYCr
RGB color pixel formats	Not applicable	BGR8, RGB8 (default)
Raw color pixel formats	Not applicable	BayerRG8, BayerRG10, BayerRG10p, BayerRG12, BayerRG12p, BayerRG12Packed
Maximum frame rate	23 fps (at 122 MByte/s)	
Exposure time	23 μs to 10 s (at 122 MByte/s)	
Exposure modes	Timed	
Gain	0 dB to 48 dB; 0.1 dB increments	
Digital binning	Horizontal: 1 to 8 columns; Vertical: 1 to 8 rows	
Sensor binning (H × V)	2 × 2 (<i>Sum</i>)	Not applicable
Multiple ROI (H × V)	<i>Free</i> <i>Tile</i> <i>Horizontal</i> : 1 × 1 to 1 × 4 <i>Vertical</i> : 1 × 1 to 4 × 1	
Image buffer (RAM)	32 MByte	
Non-volatile memory (Flash)	1024 KByte	
Inputs and outputs	1 opto-isolated input, 1 opto-isolated output, 2 non-isolated GPIOs ¹	
Power requirements	12 to 24 VDC	
Power requirements (PoE)	IEEE 802.3af	
Power consumption (typical)	External power: 3.2 W at 12 VDC Power over Ethernet: 3.6 W	

¹ Use with external power only, not with PoE. See [I/Os and power supply by PoE](#) on page 50.

Table 45: Alvium G1-510m/c specifications (sheet 1 of 2)

Feature	Specification			
Storage temperature	-20 °C to +85 °C ambient temperature			
Operating temperature	Hardware option	Housing ²	Cooling area ³	Mainboard ⁴
	G1 BL No Mount ⁵	-20 °C to +65 °C	-20 °C to +85 °C	-20 °C to +85 °C
	G1 BL with mount ⁶	-20 °C to +65 °C	-20 °C to +85 °C	
	Closed Housing	-20 °C to +65 °C	Not applicable	
Relative humidity	0% to 80% (non-condensing)			
Digital interface	1000BASE-T			
Camera controls	GenICam (GenICam Access)			

² Including the interface unit for G1 BL models

³ See [Heat dissipation for Alvium G1 BL](#) on page 192 and [Mounting the G1 BL interface unit](#) on page 201.

⁴ Output by `DeviceTemperature`

⁵ Ensure that the sensor is operated in the temperature range specified by the manufacturer. For any questions, please visit www.alliedvision.com/en/support.

Housing temperature applies to the interface unit only.

⁶ Temperature values must be observed for the housing **and** for the cooling areas.

Table 45: Alvium G1-510m/c specifications (sheet 2 of 2)

Absolute QE

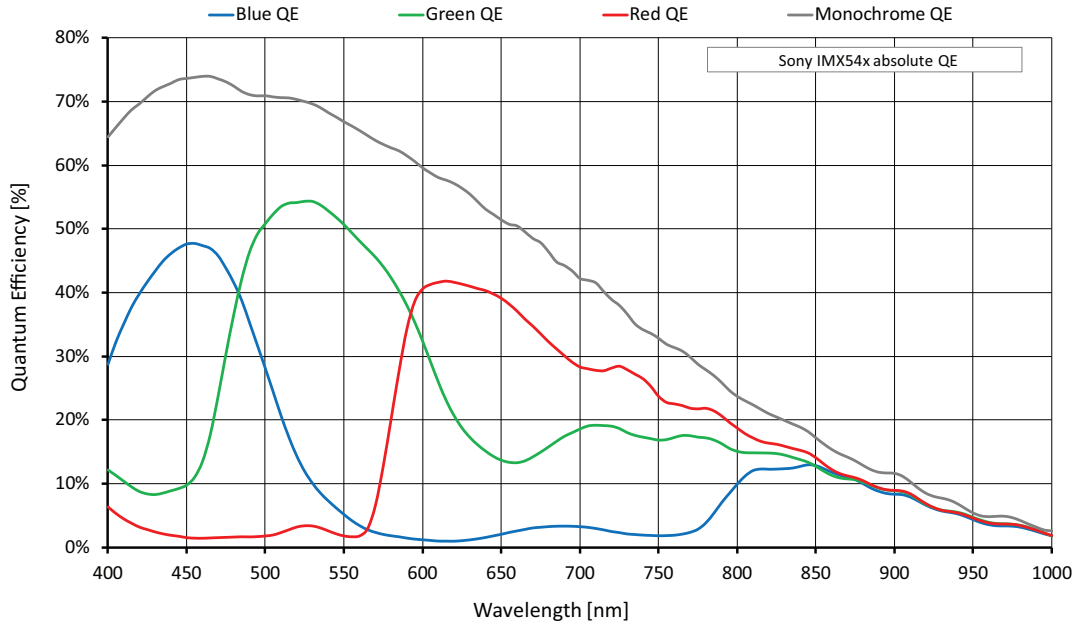

Figure 23: Alvium G1-510m/c (Sony IMX547) absolute QE

Spectral response

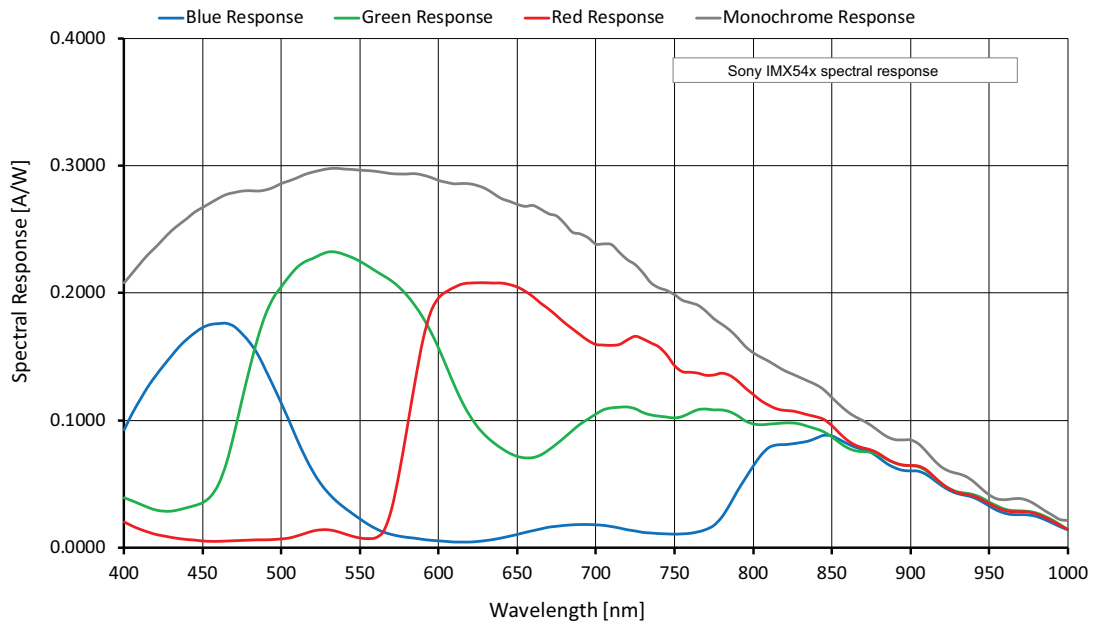

Figure 24: Alvium G1-510m/c (Sony IMX547) spectral response

ROI frame rates

Values are based on the conditions defined in [Specified values](#) on page 59.

Currently, Alvium G1-510 models can be operated only at 122 MByte/s.

Image format	Width [pixels]	Height [pixels]	ROI area [MP]	Frame rate [fps] ¹
				122 MByte/s
Full resolution	2464	2064	5.086	23.2/11.6
QXGA	2048	1536	3.146	37.6/18.8
Full HD	1920	1080	2.074	57.1/28.5
UXGA	1600	1200	1.92	61.6/30.8
WXGA+	1440	900	1.296	91.3/45.6
SXGA	1280	1024	1.311	90.3/45.1
HD 720	1280	720	0.922	128.4/64.2
XGA	1024	768	0.786	148.5/75.2
SVGA	800	600	0.48	182.4/123.2
VGA	640	480	0.307	217.9/192.6
HVGA	480	320	0.154	291.9/291.9
QVGA	320	240	0.077	351.7/351.7
HQVGA	240	160	0.038	442.1/442.1
QQVGA	160	120	0.019	507.4/507.4
Max. × half	2472	1032	2.551	46.4/23.2
Max. × min.	2472	8	0.02	512.4/279.8
Min. × max.	8	2064	0.017	62.1/62.1
Min. × min.	8	8	64 P	864.8/864.8

¹ Mono8 or Bayer...8⁽²⁾ at SensorBitDepth = 12-Bit / Mono12 or Bayer...12 at SensorBitDepth = 12-Bit

² The three dots... represent the colors of a Bayer pixel format, such as in BayerRG8.

Table 46: Alvium G1-510m/c ROI frame rates

Alvium G1-811m/c

Feature	Specification	
	G1-811m (monochrome)	G1-811c (color)
Sensor model	Sony IMX546	
Resolution	2848 (H) × 2848 (V); 8.1 MP	
Sensor type	CMOS	
Shutter type	Global shutter (GS)	
Sensor size	Type 2/3; 7.8 mm × 7.8 mm; 11.0 mm diagonal	
Pixel size	2.74 μm × 2.74 μm	
CRA	0 deg	
Sensor bit depth (ADC)	12-bit	
Monochrome pixel formats	Mono8 (default), Mono10, Mono10p, Mono12, Mono12p, Mono12Packed	Mono8, Mono10, Mono10p, Mono12, Mono12p, Mono12Packed
YUV color pixel formats	Not applicable	YCbCr411_8_CbYYCrYY, YCbCr422_8_CbYCrY, YCbCr8_CbYCr
RGB color pixel formats	Not applicable	BGR8, RGB8 (default)
Raw color pixel formats	Not applicable	BayerRG8, BayerRG10, BayerRG10p, BayerRG12, BayerRG12p, BayerRG12Packed
Maximum frame rate	14 fps (at 122 MByte/s)	
Exposure time	26 μs to 10 s (at 122 MByte/s)	
Exposure modes	Timed	
Gain	0 dB to 48 dB; 0.1 dB increments	
Digital binning	Horizontal: 1 to 8 columns; Vertical: 1 to 8 rows	
Sensor binning (H × V)	2 × 2 (<i>Sum</i>)	Not applicable
Multiple ROI (H × V)	<i>Free</i> <i>Tile</i> <i>Horizontal</i> : 1 × 1 to 1 × 4 <i>Vertical</i> : 1 × 1 to 4 × 1	
Image buffer (RAM)	32 MByte	
Non-volatile memory (Flash)	1024 KByte	
Inputs and outputs	1 opto-isolated input, 1 opto-isolated output, 2 non-isolated GPIOs ¹	
Power requirements	12 to 24 VDC	
Power requirements (PoE)	IEEE 802.3af	
Power consumption (typical)	External power: 3.7 W at 12 VDC Power over Ethernet: 4.0 W	

¹ Use with external power only, not with PoE. See [I/Os and power supply by PoE](#) on page 50.

Table 47: Alvium G1-811m/c specifications (sheet 1 of 2)

Feature	Specification			
Storage temperature	-20 °C to +85 °C ambient temperature			
Operating temperature	Hardware option	Housing ²	Cooling area ³	Mainboard ⁴
	G1 BL No Mount ⁵	-20 °C to +65 °C	-20 °C to +85 °C	-20 °C to +85 °C
	G1 BL with mount ⁶	-20 °C to +65 °C	-20 °C to +85 °C	
Closed Housing	-20 °C to +65 °C	Not applicable		
Relative humidity	0% to 80% (non-condensing)			
Digital interface	1000BASE-T			
Camera controls	GenICam (GenICam Access)			

² Including the interface unit for G1 BL models

³ See [Heat dissipation for Alvium G1 BL](#) on page 192 and [Mounting the G1 BL interface unit](#) on page 201.

⁴ Output by DeviceTemperature

⁵ Ensure that the sensor is operated in the temperature range specified by the manufacturer. For any questions, please visit www.alliedvision.com/en/support.

Housing temperature applies to the interface unit only.

⁶ Temperature values must be observed for the housing **and** for the cooling areas.

Table 47: Alvium G1-811m/c specifications (sheet 2 of 2)

Absolute QE

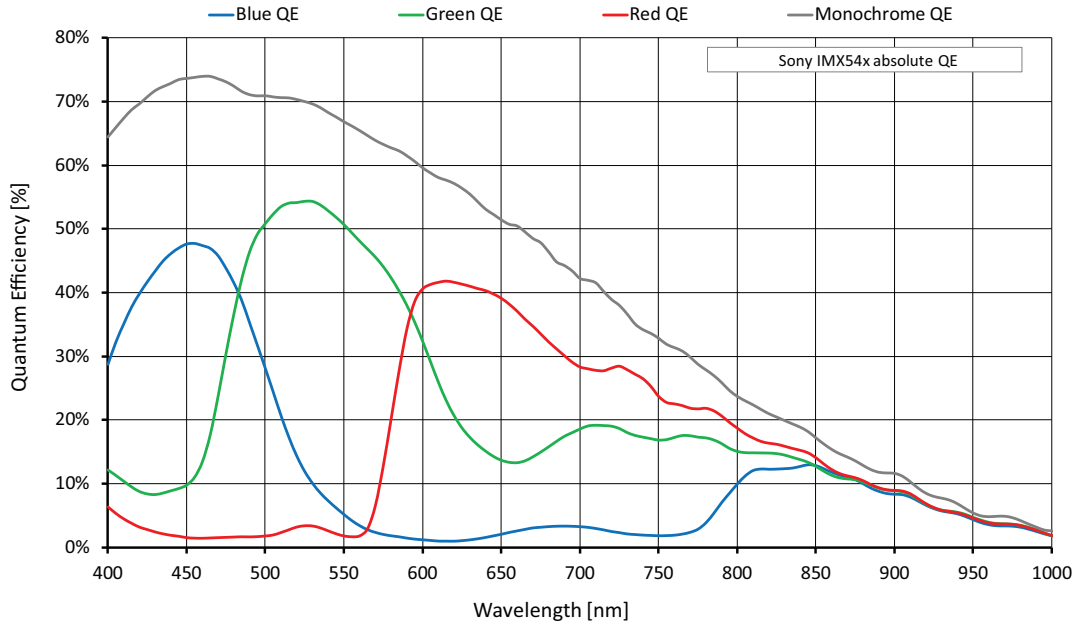

Figure 25: Alvium G1-811m/c (Sony IMX546) absolute QE

Spectral response

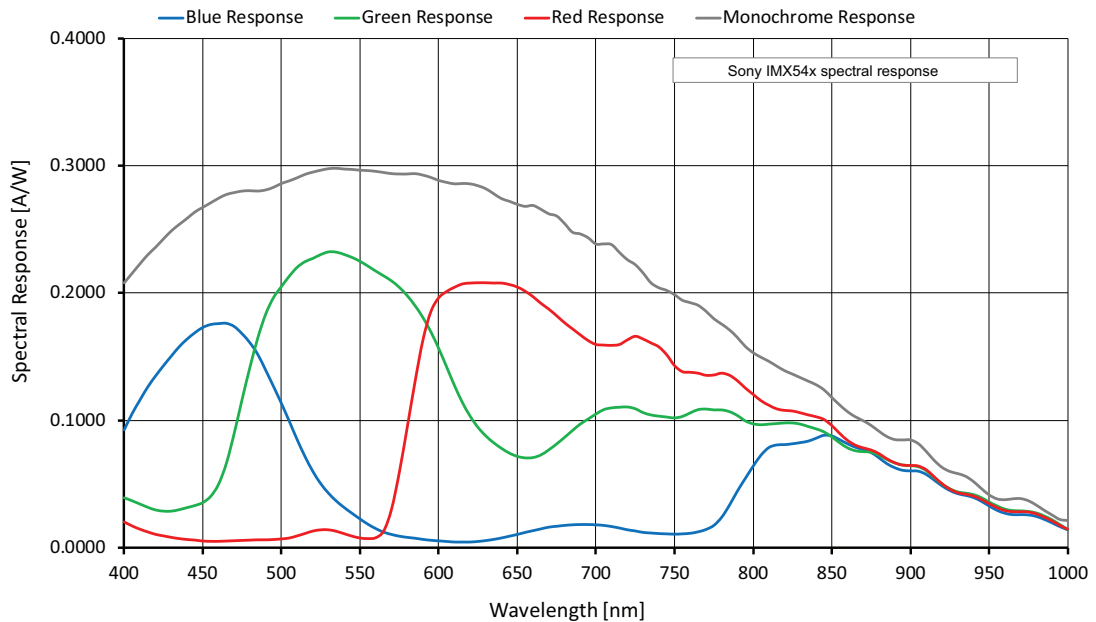

Figure 26: Alvium G1-811m/c (Sony IMX546) spectral response

ROI frame rates

Values are based on the conditions defined in [Specified values](#) on page 59.

Currently, Alvium G1-811 models can be operated only at 122 MByte/s.

Image format	Width [pixels]	Height [pixels]	ROI area [MP]	Frame rate [fps] ¹
				122 MByte/s
Full resolution	2848	2848	8.111	14.6/7.3
QSXGA	2560	2048	5.243	22.6/11.3
WQHD	2560	1440	3.686	32.1/16.1
QXGA	2048	1536	3.146	37.6/18.8
Full HD	1920	1080	2.074	57.1/28.5
UXGA	1600	1200	1.92	61.6/30.8
WXGA+	1440	900	1.296	91.3/45.6
SXGA	1280	1024	1.311	90.3/45.1
HD 720	1280	720	0.922	128.4/64.2
XGA	1024	768	0.786	132.2/75.2
SVGA	800	600	0.48	162.6/123.2
VGA	640	480	0.307	194.4/192.6
HVGA	480	320	0.154	262.0/261.5
QVGA	320	240	0.077	316.8/316.8
HQVGA	240	160	0.038	400.4/400.4
QQVGA	160	120	0.019	461.3/461.3
Max. × half	2848	1424	4.056	29.2/14.6
Max. × min.	2848	8	0.023	460.5/251.8
Min. × max.	8	2848	0.023	40.6/40.6
Min. × min.	8	8	64 P	803.5/803.5

¹ Mono8 or Bayer...8⁽²⁾ at SensorBitDepth = 12-Bit /
Mono12 or Bayer...12 at SensorBitDepth = 12-Bit

² The three dots... represent the colors of a Bayer pixel format, such as in BayerRG8.

Table 48: Alvium G1-811m/c ROI frame rates

Alvium G1-812 UV



NOTICE

Sensor aging by UV radiation

The sensor in this camera model is dedicated for imaging in the UV spectrum. However, UV radiation causes aging, which is permanently increasing the dark current and decreasing the QE (quantum efficiency).

To reduce sensor aging, we recommend you to:

- Minimize the intensity of UV radiation.
- Avoid wavelengths below 250 nm. For example, consider the use of bandpass filters to block shorter wavelengths.

Feature	Specification	
	G1-812 (monochrome)	
Sensor model	Sony IMX487	
Resolution	2848 (H) × 2848 (V); 8.1 MP	
Sensor type	CMOS	
Shutter type	Global shutter (GS)	
Sensor size	Type 2/3; 7.8 mm × 7.8 mm; 11.0 mm diagonal	
Pixel size	2.74 μm × 2.74 μm	
CRA	0 deg	
Sensor bit depth (ADC)	12-bit	
Monochrome pixel formats	Mono8 (default), Mono10, Mono10p, Mono12, Mono12p, Mono12Packed	
Maximum frame rate	14 fps (at 122 MByte/s)	
Exposure time	26 μs to 10 s (at 122 MByte/s)	
Exposure modes	Timed, TriggerControlled, TriggerWidth	
Gain	0 dB to 48 dB; 0.1 dB increments	
Digital binning	Horizontal: 1 to 8 columns; Vertical: 1 to 8 rows	
Sensor binning (H × V)	2 × 2 (<i>Sum</i>)	Not applicable
Multiple ROI (H × V)	<i>Free Tile Horizontal</i> : 1 × 1 to 1 × 4 <i>Vertical</i> : 1 × 1 to 4 × 1	
Image buffer (RAM)	32 MByte	
Non-volatile memory (Flash)	1024 KByte	
Inputs and outputs	1 opto-isolated input, 1 opto-isolated output, 2 non-isolated GPIOs ¹	

¹ Use with external power only, not with PoE. See [I/Os and power supply by PoE](#) on page 50.

Table 49: Alvium G1-812 UV specifications (sheet 1 of 2)

Feature	Specification			
Power requirements	12 to 24 VDC			
Power requirements (PoE)	IEEE 802.3af			
Power consumption (typical)	External power: 4.0 W at 12 VDC Power over Ethernet: 4.6 W			
Storage temperature	-20 °C to +85 °C ambient temperature			
Operating temperature	Hardware option	Housing²	Cooling area³	Mainboard⁴
	G1 BL No Mount ⁵	-20 °C to +65 °C	-20 °C to +85 °C	-20 °C to +85 °C
	G1 BL with mount ⁶	-20 °C to +65 °C	-20 °C to +85 °C	
	Closed Housing	-20 °C to +65 °C	Not applicable	
Relative humidity	0% to 80% (non-condensing)			
Digital interface	1000BASE-T			
Camera controls	GenICam (GenICam Access)			
² Including the interface unit for G1 BL models ³ See Heat dissipation for Alvium G1 BL on page 192 and Mounting the G1 BL interface unit on page 201. ⁴ Output by DeviceTemperature ⁵ Ensure that the sensor is operated in the temperature range specified by the manufacturer. For any questions, please visit www.alliedvision.com/en/support . Housing temperature applies to the interface unit only. ⁶ Temperature values must be observed for the housing and for the cooling areas.				

Table 49: Alvium G1-812 UV specifications (sheet 2 of 2)

Absolute QE

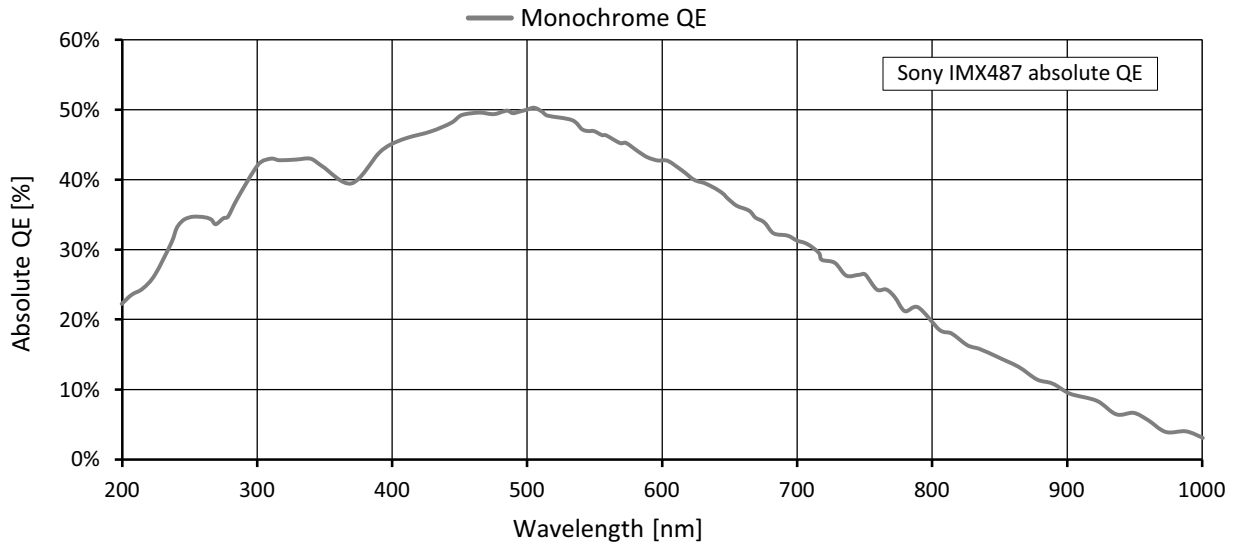

Figure 27: Alvium G1-812 UV (Sony IMX487) absolute QE

Spectral response

We intend to add a diagram in a future version of this document.

ROI frame rates

Values are based on the conditions defined in [Specified values](#) on page 59.

Currently, Alvium G1-812 UV models can be operated only at 122 MByte/s.

Image format	Width [pixels]	Height [pixels]	ROI area [MP]	Frame rate [fps] ¹
				122 MByte/s
Full resolution	2848	2848	8.111	14.6/7.3
QSXGA	2560	2048	5.243	22.6/11.3
WQHD	2560	1440	3.686	32.1/16.1
QXGA	2048	1536	3.146	37.6/18.8
Full HD	1920	1080	2.074	57.1/28.5
UXGA	1600	1200	1.92	61.6/30.8
WXGA+	1440	900	1.296	91.3/45.6
SXGA	1280	1024	1.311	90.3/45.1
HD 720	1280	720	0.922	128.4/64.2
XGA	1024	768	0.786	129.3/75.2
SVGA	800	600	0.48	156.7/123.2
VGA	640	480	0.307	188.4/188.4
HVGA	480	320	0.154	251.2/250.7
QVGA	320	240	0.077	301.0/301.0
HQVGA	240	160	0.038	375.6/375.6
QQVGA	160	120	0.019	416.9/416.9
Max. × half	2848	1424	4.056	29.2/14.6
Max. × min.	2848	8	0.023	395.1/213.5
Min. × max.	8	2848	0.023	40.3/40.3
Min. × min.	8	8	64 P	677.8/677.8

¹ Mono8 or Bayer...8⁽²⁾ at `SensorBitDepth` = 12-Bit /
Mono12 or Bayer...12 at `SensorBitDepth` = 12-Bit

² The three dots... represent the colors of a Bayer pixel format, such as in Bayer**RG8**.

Table 50: Alvium G1-812 UV ROI frame rates

Alvium G1-895m/c

Feature	Specification	
	G1-895m (monochrome)	G1-895c (color)
Sensor model	Sony IMX267	
Resolution	4112 (H) × 2176 (V); 8.95 MP	
Sensor type	CMOS	
Shutter type	Global shutter (GS)	
Sensor size	Type 1; 14.2 mm × 7.5 mm; 16.0 mm diagonal	
Pixel size	3.45 μm × 3.45 μm	
CRA	0 deg	
Sensor bit depth (ADC)	12-bit	
Monochrome pixel formats	Mono8 (default), Mono10, Mono10p, Mono12, Mono12p, Mono12Packed	Mono8, Mono10, Mono10p, Mono12, Mono12p, Mono12Packed
YUV color pixel formats	Not applicable	YCbCr411_8_CbYYCrYY, YCbCr422_8_CbYCrY, YCbCr8_CbYCr
RGB color pixel formats	Not applicable	BGR8, RGB8 (default)
Raw color pixel formats	Not applicable	BayerRG8, BayerRG10, BayerRG10p, BayerRG12, BayerRG12p, BayerRG12Packed
Maximum frame rate	13 fps (at 122 MByte/s)	
Exposure time	48 μs to 10 s (at 122 MByte/s)	
Exposure modes	Timed, TriggerControlled, TriggerWidth	
Gain	0 dB to 48 dB; 0.1 dB increments	
Digital binning ¹	Horizontal: 1 to 8 columns; Vertical: 1 to 8 rows	
Multiple ROI (H × V)	<i>Free</i>	
Image buffer (RAM)	32 MByte	
Non-volatile memory (Flash)	1024 KByte	
Inputs and outputs	1 opto-isolated input, 1 opto-isolated output, 2 non-isolated GPIOs ²	
Power requirements	12 to 24 VDC	
Power requirements (PoE)	IEEE 802.3af	
Power consumption (typical)	External power: 3.5 W at 12 VDC Power over Ethernet: 3.9 W	

¹ Digital vertical binning can be used only when digital horizontal binning is used as well.

² Use with external power only, not with PoE. See [I/Os and power supply by PoE](#) on page 50.

Table 51: Alvium G1-895m/c specifications (sheet 1 of 2)

Feature	Specification			
Storage temperature	-20 °C to +85 °C ambient temperature			
Operating temperature	Hardware option	Housing ³	Cooling area ⁴	Mainboard ⁵
	G1 BL No Mount ⁶	-20 °C to +65 °C	-20 °C to +85 °C	-20 °C to +88 °C
	G1 BL with mount ⁷	-20 °C to +65 °C	-20 °C to +85 °C	
	Closed Housing	-20 °C to +65 °C	Not applicable	
Relative humidity	0% to 80% (non-condensing)			
Digital interface	1000BASE-T			
Camera controls	GenICam (GenICam Access)			

³ Including the interface unit for G1 BL models

⁴ See [Heat dissipation for Alviium G1 BL](#) on page 192 and [Mounting the G1 BL interface unit](#) on page 201.

⁵ Output by DeviceTemperature

⁶ Ensure that the sensor is operated in the temperature range specified by the manufacturer. For any questions, please visit www.alliedvision.com/en/support.

Housing temperature applies to the interface unit only.

⁷ Temperature values must be observed for the housing **and** for the cooling areas.

Table 51: Alviium G1-895m/c specifications (sheet 2 of 2)

Absolute QE

We intend to add diagrams in a future version of this document.

Spectral response

We intend to add diagrams in a future version of this document.

ROI frame rates

Values are based on the conditions defined in [Specified values](#) on page 59.

Currently, Alvium G1-895 models can be operated only at 122 MByte/s.

Image format	Width [pixels]	Height [pixels]	ROI area [MP]	Frame rate [fps] ¹
				122 MByte/s
Full resolution	4112	2176	8.948	13.2/6.6
UHD 4K	3840	2160	8.294	14.3/7.1
QSXGA	2560	2048	5.243	22.6/11.3
WQHD	2560	1440	3.686	32.1/16.1
QXGA	2048	1536	3.146	37.6/18.8
Full HD	1920	1080	2.074	57.1/28.5
UXGA	1600	1200	1.92	56.5/30.8
WXGA+	1440	900	1.296	74.3/45.6
SXGA	1280	1024	1.311	65.9/45.2
HD 720	1280	720	0.922	91.8/64.2
XGA	1024	768	0.786	86.6/75.2
SVGA	800	600	0.48	109.2/109.2
VGA	640	480	0.307	134.2/134.2
HVGA	480	320	0.154	193.3/193.3
QVGA	320	240	0.077	247.8/247.8
HQVGA	240	160	0.038	345.2/345.2
QQVGA	160	120	0.019	428.4/428.4
Max. × half	4112	1088	4.474	26.5/13.2
Max. × min.	4112	8	0.033	681.4/413.0
Min. × max.	8	2176	0.017	32.0/32.0
Min. × min.	8	8	64 P	1317.0/1317.0

¹ Mono8 or Bayer...8⁽²⁾ at SensorBitDepth = 12-Bit /
Mono12 or Bayer...12 at SensorBitDepth = 12-Bit

² The three dots... represent the colors of a Bayer pixel format, such as in BayerRG8.

Table 52: Alvium G1-895m/c ROI frame rates

Alvium G1-1236m/c

Feature	Specification	
	G1-1236m (monochrome)	G1-1236c (color)
Sensor model	Sony IMX304	
Resolution	4112 (H) × 3008 (V); 12.4 MP	
Sensor type	CMOS	
Shutter type	Global shutter (GS)	
Sensor size	Type 1.1; 14.2 mm × 10.4 mm; 17.6 mm diagonal	
Pixel size	3.45 μm × 3.45 μm	
CRA	0 deg	
Sensor bit depth (ADC)	12-bit	
Monochrome pixel formats	Mono8 (default), Mono10, Mono10p, Mono12, Mono12p, Mono12Packed	Mono8, Mono10, Mono10p, Mono12, Mono12p, Mono12Packed
YUV color pixel formats	Not applicable	YCbCr411_8_CbYYCrYY, YCbCr422_8_CbYCrY, YCbCr8_CbYCr
RGB color pixel formats	Not applicable	BGR8, RGB8 (default)
Raw color pixel formats	Not applicable	BayerRG8, BayerRG10, BayerRG10p, BayerRG12, BayerRG12p, BayerRG12Packed
Maximum frame rate	9.6 fps (at 122 MByte/s)	
Exposure time	48 μs to 10 s (at 122 MByte/s)	
Exposure modes	Timed, TriggerControlled, TriggerWidth	
Gain	0 dB to 48 dB; 0.1 dB increments	
Digital binning ¹	Horizontal: 1 to 8 columns; Vertical: 1 to 8 rows	
Multiple ROI (H × V)	<i>Free</i>	
Image buffer (RAM)	32 MByte	
Non-volatile memory (Flash)	1024 KByte	
Inputs and outputs	1 opto-isolated input, 1 opto-isolated output, 2 non-isolated GPIOs ²	
Power requirements	12 to 24 VDC	
Power requirements (PoE)	IEEE 802.3af	
Power consumption (typical)	External power: 3.8 W at 12 VDC Power over Ethernet: 4.0 W	

¹ Digital vertical binning can be used only when digital horizontal binning is used as well.

² Use with external power only, not with PoE. See [I/Os and power supply by PoE](#) on page 50.

Table 53: Alvium G1-1236m/c specifications (sheet 1 of 2)

Feature	Specification			
Storage temperature	-20 °C to +85 °C ambient temperature			
Operating temperature	Hardware option	Housing ³	Cooling area ⁴	Mainboard ⁵
	G1 BL No Mount ⁶	-20 °C to +65 °C	-20 °C to +85 °C	-20 °C to +88 °C
	G1 BL with mount ⁷	-20 °C to +65 °C	-20 °C to +85 °C	
Closed Housing	-20 °C to +65 °C	Not applicable		
Relative humidity	0% to 80% (non-condensing)			
Digital interface	1000BASE-T			
Camera controls	GenICam (GenICam Access)			
³ Including the interface unit for G1 BL models ⁴ See Heat dissipation for Alvium G1 BL on page 192 and Mounting the G1 BL interface unit on page 201. ⁵ Output by DeviceTemperature ⁶ Ensure that the sensor is operated in the temperature range specified by the manufacturer. For any questions, please visit www.alliedvision.com/en/support . Housing temperature applies to the interface unit only. ⁷ Temperature values must be observed for the housing and for the cooling areas.				

Table 53: Alvium G1-1236m/c specifications (sheet 2 of 2)

Absolute QE

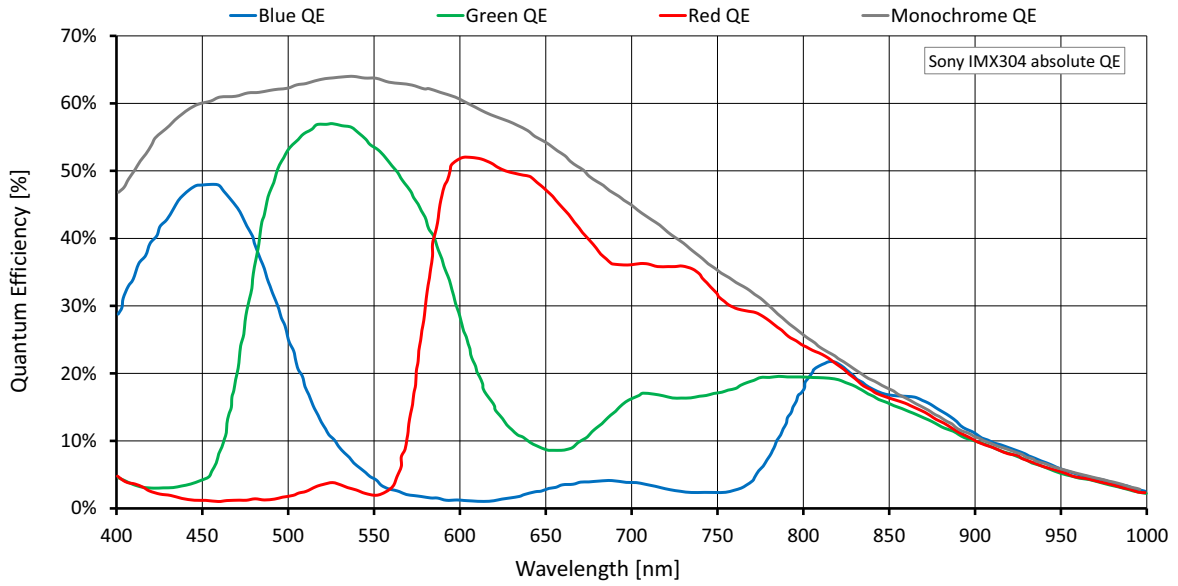

Figure 28: Alvium G1-1236m/c (Sony IMX304) absolute QE

Spectral response

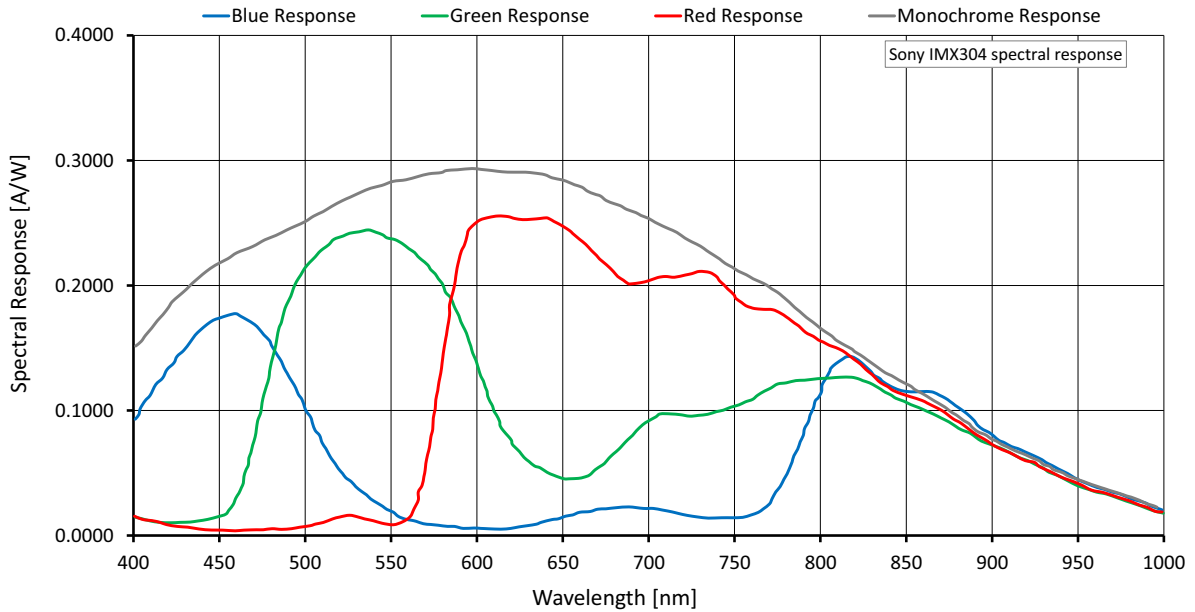

Figure 29: Alvium G1-1236m/c (Sony IMX304) spectral response

ROI frame rates

Values are based on the conditions defined in [Specified values](#) on page 59.

Currently, Alvium G1-1236 models can be operated only at 122 MByte/s.

Image format	Width [pixels]	Height [pixels]	ROI area [MP]	Frame rate [fps] ¹
				122 MByte/s
Full resolution	4112	3008	12.369	9.6/4.8
UHD 4K	3840	2160	8.294	14.3/7.1
QSXGA	2560	2048	5.243	22.6/11.3
WQHD	2560	1440	3.686	32.1/16.1
QXGA	2048	1536	3.146	37.6/18.8
Full HD	1920	1080	2.074	57.1/28.5
UXGA	1600	1200	1.92	56.3/30.8
WXGA+	1440	900	1.296	73.9/45.6
SXGA	1280	1024	1.311	65.5/45.2
HD 720	1280	720	0.922	91.1/64.2
XGA	1024	768	0.786	86.0/75.2
SVGA	800	600	0.48	108.2/108.2
VGA	640	480	0.307	132.7/132.7
HVGA	480	320	0.154	190.2/190.2
QVGA	320	240	0.077	242.7/242.7
HQVGA	240	160	0.038	335.5/335.5
QQVGA	160	120	0.019	413.5/413.5
Max. × half	4112	1504	6.184	19.1/9.6
Max. × min.	4112	8	0.033	633.9/378.6
Min. × max.	8	3008	0.024	23.2/23.2
Min. × min.	8	8	64 P	1185.3/1185.3

¹ Mono8 or Bayer...8⁽²⁾ at SensorBitDepth = 12-Bit /
Mono12 or Bayer...12 at SensorBitDepth = 12-Bit

² The three dots... represent the colors of a Bayer pixel format, such as in BayerRG8.

Table 54: Alvium G1-1236m/c ROI frame rates

Alvium G1-1240m/c

Feature	Specification	
	G1-1240m (monochrome)	G1-1240c (color)
Sensor model	Sony IMX226	
Resolution	4024 (H) x 3036 (V); 12.2 MP	
Sensor type	CMOS	
Shutter type	Rolling shutter (RS) or Global reset shutter (GRS)	
Sensor size	Type 1/1.7; 7.4 mm × 5.6 mm; 9.3 mm diagonal	
Pixel size	1.85 μm × 1.85 μm	
CRA	0 deg	
Sensor bit depth (ADC)	10-bit	
Monochrome pixel formats	Mono8 (default), Mono10, Mono10p, Mono12, Mono12p, Mono12Packed	Mono8, Mono10, Mono10p, Mono12, Mono12p, Mono12Packed
YUV color pixel formats	Not applicable	YCbCr411_8_CbYYCrYY, YCbCr422_8_CbYCrY, YCbCr8_CbYCr
RGB color pixel formats	Not applicable	BGR8, RGB8 (default)
Raw color pixel formats	Not applicable	BayerRG8, BayerRG10, BayerRG10p, BayerRG12, BayerRG12p, BayerRG12Packed
Maximum frame rate	9.7 fps ¹ (at 122 MByte/s)	
Exposure time	36 μs to 10 s (at 122 MByte/s)	
Exposure modes	Timed	
Gain	0 dB to 27 dB; 0.1 dB increments	
Digital binning ²	Horizontal: 1 to 8 columns; Vertical: 1 to 8 rows	
Image buffer (RAM)	32 MByte	
Non-volatile memory (Flash)	1024 KByte	
Inputs and outputs	1 opto-isolated input, 1 opto-isolated output, 2 non-isolated GPIOs ³	
Power requirements	12 to 24 VDC	
Power requirements (PoE)	IEEE 802.3af	
Power consumption (typical)	External power: 3.6 W at 12 VDC Power over Ethernet: 4.0 W	
¹ In triggered mode: ~9.7 fps ² Digital vertical binning can be used only when digital horizontal binning is used as well. ³ Use with external power only, not with PoE. See I/Os and power supply by PoE on page 50.		

Table 55: Alvium G1-1240m/c specifications (sheet 1 of 2)

Feature	Specification			
Storage temperature	-20 °C to +85 °C ambient temperature			
Operating temperature	Hardware option	Housing ⁴	Cooling area ⁵	Mainboard ⁶
	G1 BL No Mount ⁷	-20 °C to +65 °C	-20 °C to +85 °C	-20 °C to +88 °C
	G1 BL with mount ⁸	-20 °C to +65 °C	-20 °C to +85 °C	
	Closed Housing	-20 °C to +65 °C	Not applicable	
Relative humidity	0% to 80% (non-condensing)			
Digital interface	1000BASE-T			
Camera controls	GenICam (GenICam Access)			

⁴ Including the interface unit for G1 BL models

⁵ See [Heat dissipation for Alvium G1 BL](#) on page 192 and [Mounting the G1 BL interface unit](#) on page 201.

⁶ Output by DeviceTemperature

⁷ Ensure that the sensor is operated in the temperature range specified by the manufacturer. For any questions, please visit www.alliedvision.com/en/support.

Housing temperature applies to the interface unit only.

⁸ Temperature values must be observed for the housing **and** for the cooling areas.

Table 55: Alvium G1-1240m/c specifications (sheet 2 of 2)

Absolute QE

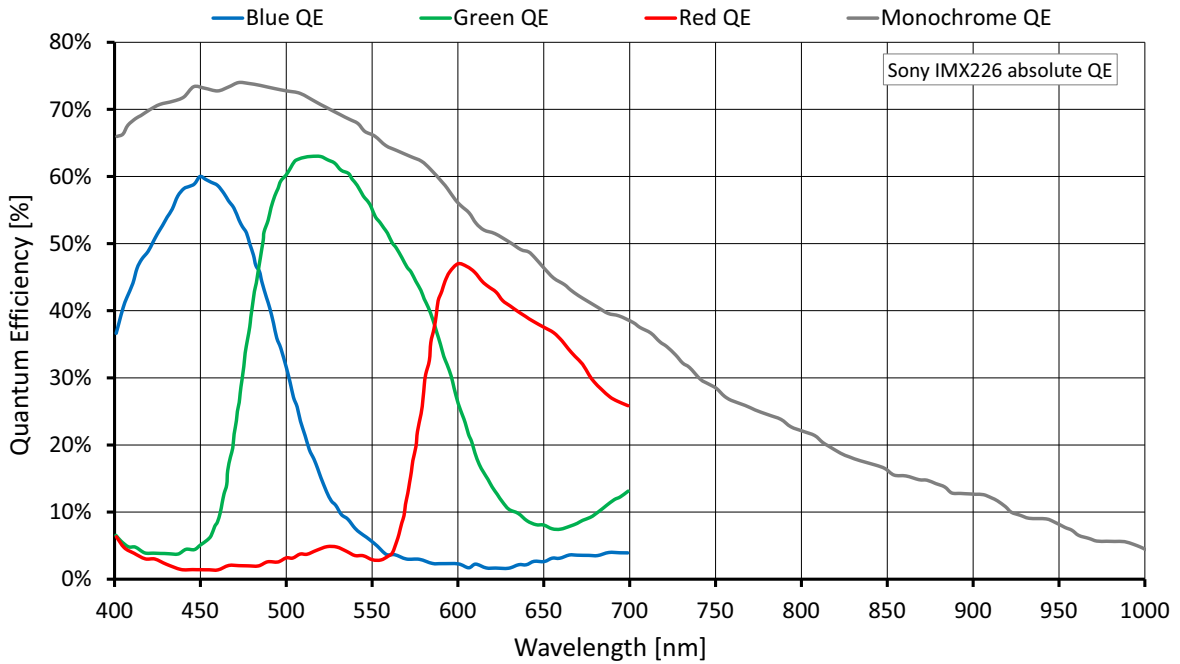

Figure 30: Alvium G1-1240m/c (Sony IMX116) absolute QE

Spectral response

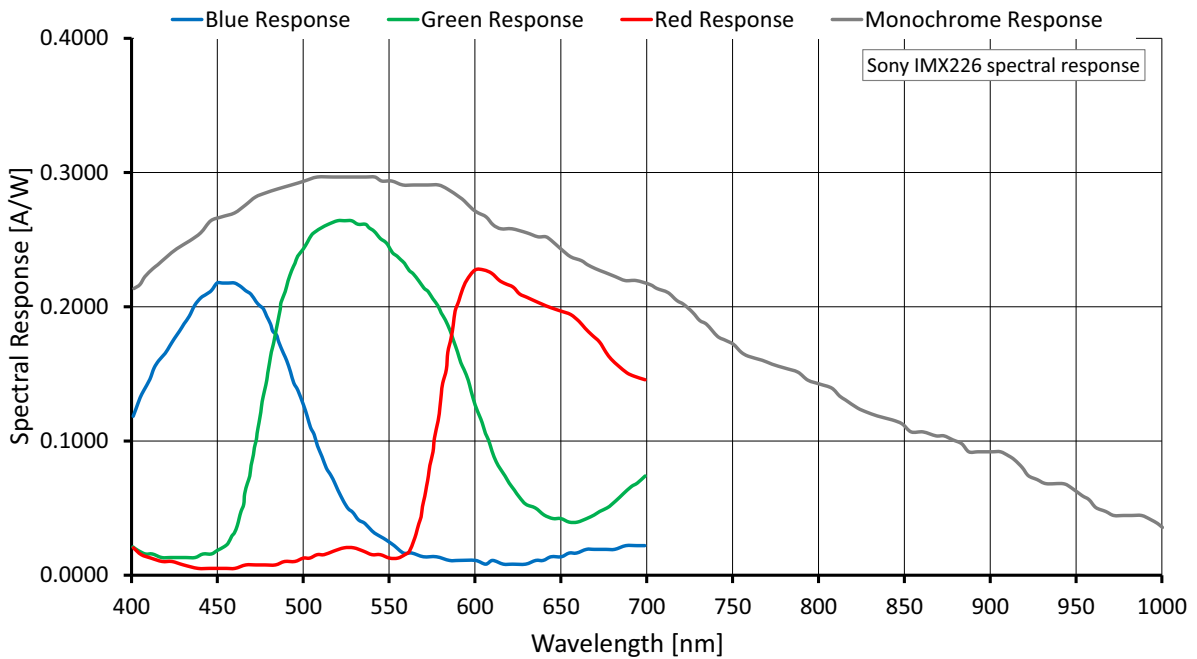

Figure 31: Alvium G1-1240m/c (Sony IMX226) spectral response

ROI frame rates

Values are based on the conditions defined in [Specified values](#) on page 59.

Shutter mode	User mode	Available frame rates
Rolling shutter (RS)	Freerun	Values in Table 57 below are reached.
Rolling shutter (RS)	Triggered	>99% of the values for in Table 57 below are reached.
Global reset shutter (GRS)	Freerun	>99% of the values for in Table 57 below are reached.
Global reset shutter (GRS)	Triggered	

Table 56: Frame rate behavior for different configurations

Currently, Alvium G1-1240 models can be operated only at 122 MByte/s.

Image format	Width [pixels]	Height [pixels]	ROI area [MP]	Frame rate [fps] ¹
				122 MByte/s
Full resolution	4024	3036	12.217	9.7/4.8
UHD 4K	3840	2160	8.294	14.3/7.1
QSXGA	2560	2048	5.243	22.3/11.2
WQHD	2560	1440	3.686	22.3/11.2
QXGA	2048	1536	3.146	22.3/11.2
Full HD	1920	1080	2.074	22.3/11.2
UXGA	1600	1200	1.92	22.3/11.2
WXGA+	1440	900	1.296	22.3/11.2
SXGA	1280	1024	1.311	22.3/11.2
HD 720	1280	720	0.922	22.3/11.2
XGA	1024	768	0.786	22.3/11.2
SVGA	800	600	0.48	22.3/11.2
VGA	640	480	0.307	22.3/11.2
HVGA	480	320	0.154	22.3/11.2
QVGA	320	240	0.077	22.3/11.2
HQVGA	240	160	0.038	22.3/11.2
QQVGA	160	120	0.019	22.3/11.2
Max. × half	4024	1518	6.108	19.4/9.7
Max. × min.	4024	8	0.032	22.3/11.2
Min. × max.	8	3036	0.024	22.3/11.2
Min. × min.	8	8	64 P	22.3/11.2

¹ Mono8 or Bayer...8⁽²⁾ at SensorBitDepth = 10-Bit /
 Mono12 or Bayer...12 at SensorBitDepth = 10-Bit

² The three dots... represent the colors of a Bayer pixel format, such as in BayerRG8.

Table 57: Alvium G1-1240m/c ROI frame rates

Alvium G1-1242m/c

Feature	Specification	
	G1-1242m (monochrome)	G1-1242c (color)
Sensor model	Sony IMX545	
Resolution	4128 (H) × 3008 (V); 12.4 MP	
Sensor type	CMOS	
Shutter type	Global shutter (GS)	
Sensor size	Type 1/1.1; 11.3 mm × 8.2 mm; 14.0 mm diagonal	
Pixel size	2.74 μm × 2.74 μm	
CRA	0 deg	
Sensor bit depth (ADC)	12-bit	
Monochrome pixel formats	Mono8 (default), Mono10, Mono10p, Mono12, Mono12p, Mono12Packed	Mono8, Mono10, Mono10p, Mono12, Mono12p, Mono12Packed
YUV color pixel formats	Not applicable	YCbCr411_8_CbYYCrYY, YCbCr422_8_CbYCrY, YCbCr8_CbYCr
RGB color pixel formats	Not applicable	BGR8, RGB8 (default)
Raw color pixel formats	Not applicable	BayerRG8, BayerRG10, BayerRG10p, BayerRG12, BayerRG12p, BayerRG12Packed
Maximum frame rate	9.5 fps (at 122 MByte/s)	
Exposure time	37 μs to 10 s (at 122 MByte/s)	
Exposure modes	Timed	
Gain	0 dB to 48 dB; 0.1 dB increments	
Digital binning ¹	Horizontal: 1 to 8 columns; Vertical: 1 to 8 rows	
Sensor binning (H × V)	2 × 2 (<i>Sum</i>)	Not applicable
Multiple ROI (H × V)	<i>Free</i> <i>Tile</i> <i>Horizontal</i> : 1 × 1 to 1 × 4 <i>Vertical</i> : 1 × 1 to 4 × 1	
Image buffer (RAM)	32 MByte	
Non-volatile memory (Flash)	1024 KByte	
Inputs and outputs	1 opto-isolated input, 1 opto-isolated output, 2 non-isolated GPIOs ²	

¹ Digital vertical binning can be used only when digital horizontal binning is used as well.

² Use with external power only, not with PoE. See [I/Os and power supply by PoE](#) on page 50.

Table 58: Alvium G1-1242m/c specifications (sheet 1 of 2)

Feature	Specification			
Power requirements	12 to 24 VDC			
Power requirements (PoE)	IEEE 802.3af			
Power consumption (typical)	External power: 3.8 W at 12 VDC Power over Ethernet: 4.0 W			
Storage temperature	-20 °C to +85 °C ambient temperature			
Operating temperature	Hardware option	Housing³	Cooling area⁴	Mainboard⁵
	G1 BL No Mount ⁶	-20 °C to +65 °C	-20 °C to +85 °C	-20 °C to +85 °C
	G1 BL with mount ⁷	-20 °C to +65 °C	-20 °C to +85 °C	
	Closed Housing	-20 °C to +65 °C	Not applicable	
Relative humidity	0% to 80% (non-condensing)			
Digital interface	1000BASE-T			
Camera controls	GenICam (GenICam Access)			
³ Including the interface unit for G1 BL models ⁴ See Heat dissipation for Alvium G1 BL on page 192 and Mounting the G1 BL interface unit on page 201. ⁵ Output by DeviceTemperature ⁶ Ensure that the sensor is operated in the temperature range specified by the manufacturer. For any questions, please visit www.alliedvision.com/en/support . Housing temperature applies to the interface unit only. ⁷ Temperature values must be observed for the housing and for the cooling areas.				

Table 58: Alvium G1-1242m/c specifications (sheet 2 of 2)

Absolute QE

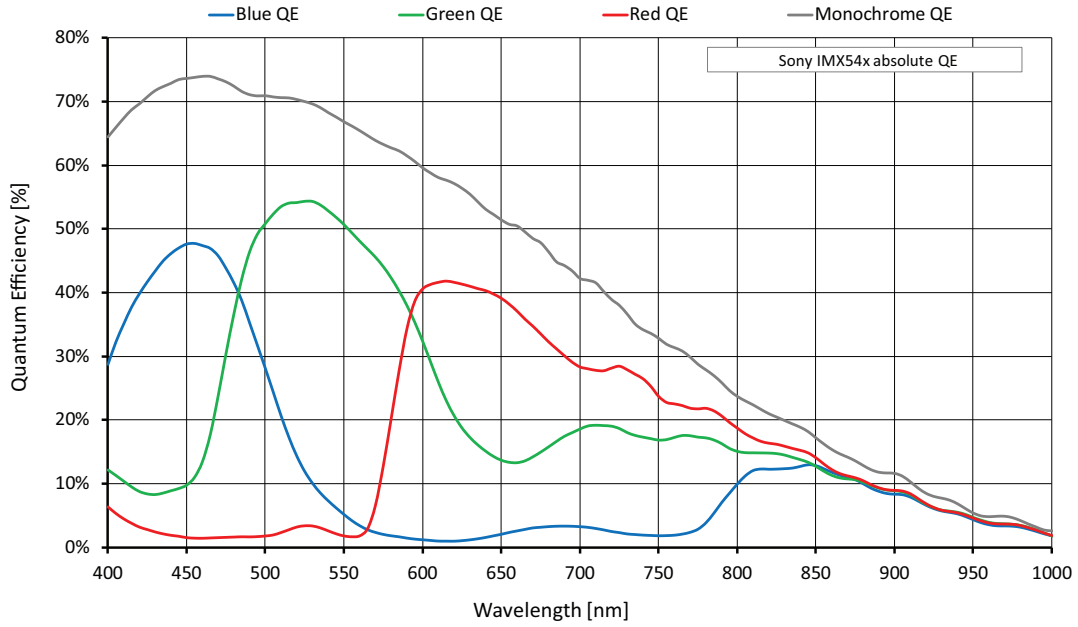

Figure 32: Alvium G1-1242m/c (Sony IMX545) absolute QE

Spectral response

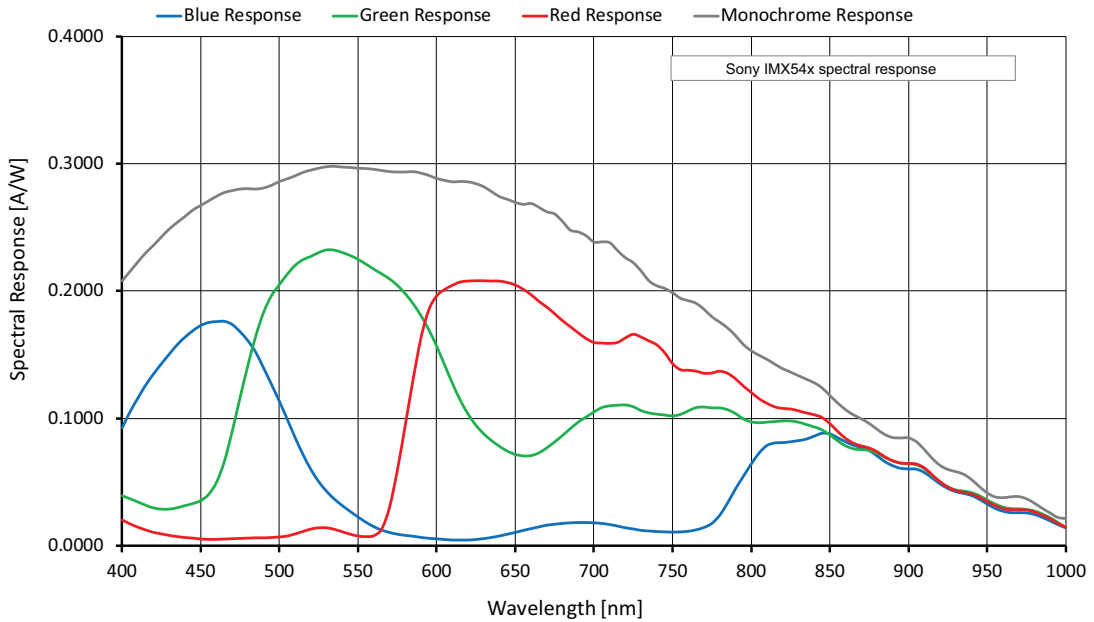

Figure 33: Alvium G1-1242m/c (Sony IMX545) spectral response

ROI frame rates

Values are based on the conditions defined in [Specified values](#) on page 59.

Currently, Alvium G1-1242 models can be operated only at 122 MByte/s.

Image format	Width [pixels]	Height [pixels]	ROI area [MP]	Frame rate [fps] ¹
				122 MByte/s
Full resolution	4128	3008	12.417	9.5/4.8
UHD 4K	3840	2160	8.294	14.3/7.1
QSXGA	2560	2048	5.243	22.6/11.3
WQHD	2560	1440	3.686	32.1/16.1
QXGA	2048	1536	3.146	37.6/18.8
Full HD	1920	1080	2.074	57.1/28.5
UXGA	1600	1200	1.92	61.6/30.8
WXGA+	1440	900	1.296	83.9/45.7
SXGA	1280	1024	1.311	75.4/45.1
HD 720	1280	720	0.922	102.1/64.2
XGA	1024	768	0.786	97.0/75.2
SVGA	800	600	0.48	119.4/119.4
VGA	640	480	0.307	143.2/143.2
HVGA	480	320	0.154	193.7/193.7
QVGA	320	240	0.077	235.3/235.3
HQVGA	240	160	0.038	299.5/299.5
QQVGA	160	120	0.019	346.9/346.9
Max. × half	4128	1504	6.209	19.1/9.5
Max. × min.	4128	8	0.033	400.1/222.4
Min. × max.	8	3008	0.024	27.9/27.9
Min. × min.	8	8	64 P	622.4/622.4

¹ Mono8 or Bayer...8⁽²⁾ at SensorBitDepth = 12-Bit /
Mono12 or Bayer...12 at SensorBitDepth = 12-Bit

² The three dots... represent the colors of a Bayer pixel format, such as in BayerRG8.

Table 59: Alvium G1-1242m/c ROI frame rates

Alvium G1-1620m/c

Feature	Specification	
	G1-1620m (monochrome)	G1-1620c (color)
Sensor model	Sony IMX542	
Resolution	5328 (H) × 3040 (V); 16.2 MP	
Sensor type	CMOS	
Shutter type	Global shutter (GS)	
Sensor size	Type 1.1; 14.6 mm × 8.3 mm; 16.8 mm diagonal	
Pixel size	2.74 μm × 2.74 μm	
CRA	0 deg	
Sensor bit depth (ADC)	12-bit	
Monochrome pixel formats	Mono8 (default), Mono10, Mono10p, Mono12, Mono12p, Mono12Packed	Mono8, Mono10, Mono10p, Mono12, Mono12p, Mono12Packed
YUV color pixel formats	Not applicable	YCbCr411_8_CbYYCrYY, YCbCr422_8_CbYCrY, YCbCr8_CbYCr
RGB color pixel formats	Not applicable	BGR8, RGB8 (default)
Raw color pixel formats	Not applicable	BayerRG8, BayerRG10, BayerRG10p, BayerRG12, BayerRG12p, BayerRG12Packed
Maximum frame rate	7.3 fps (at 122 MByte/s)	
Exposure time	47 μs to 10 s (at 122 MByte/s)	
Exposure modes	Timed, TriggerControlled, TriggerWidth	
Gain	0 dB to 48 dB; 0.1 dB increments	
Digital binning ¹	Horizontal: 1 to 8 columns; Vertical: 1 to 8 rows	
Sensor binning (H × V)	2 × 2 (<i>Sum</i>)	Not applicable
Multiple ROI (H × V)	<i>Free</i> <i>Tile</i> <i>Horizontal</i> : 1 × 1 to 1 × 4 <i>Vertical</i> : 1 × 1 to 4 × 1	
Image buffer (RAM)	32 MByte	
Non-volatile memory (Flash)	1024 KByte	
Inputs and outputs	1 opto-isolated input, 1 opto-isolated output, 2 non-isolated GPIOs ²	
Power requirements	12 to 24 VDC	
Power requirements (PoE)	IEEE 802.3af	

¹ Digital vertical binning can be used only when digital horizontal binning is used as well.

² Use with external power only, not with PoE. See [I/Os and power supply by PoE](#) on page 50.

Table 60: Alvium G1-1620m/c specifications (sheet 1 of 2)

Feature	Specification			
Power consumption (typical)	External power: 3.7 W at 12 VDC Power over Ethernet: 4.1 W			
Storage temperature	-20 °C to +85 °C ambient temperature			
Operating temperature	Hardware option	Housing³	Cooling area⁴	Mainboard⁵
	G1 BL No Mount ⁶	-20 °C to +65 °C	-20 °C to +85 °C	-20 °C to +85 °C
	G1 BL with mount ⁷	-20 °C to +65 °C	-20 °C to +85 °C	
	Closed Housing	-20 °C to +65 °C	Not applicable	
Relative humidity	0% to 80% (non-condensing)			
Digital interface	1000BASE-T			
Camera controls	GenICam (GenICam Access)			

³ Including the interface unit for G1 BL models

⁴ See [Heat dissipation for Alvium G1 BL](#) on page 192 and [Mounting the G1 BL interface unit](#) on page 201.

⁵ Output by `DeviceTemperature`

⁶ Ensure that the sensor is operated in the temperature range specified by the manufacturer. For any questions, please visit www.alliedvision.com/en/support.

Housing temperature applies to the interface unit only.

⁷ Temperature values must be observed for the housing **and** for the cooling areas.

Table 60: Alvium G1-1620m/c specifications (sheet 2 of 2)

Absolute QE

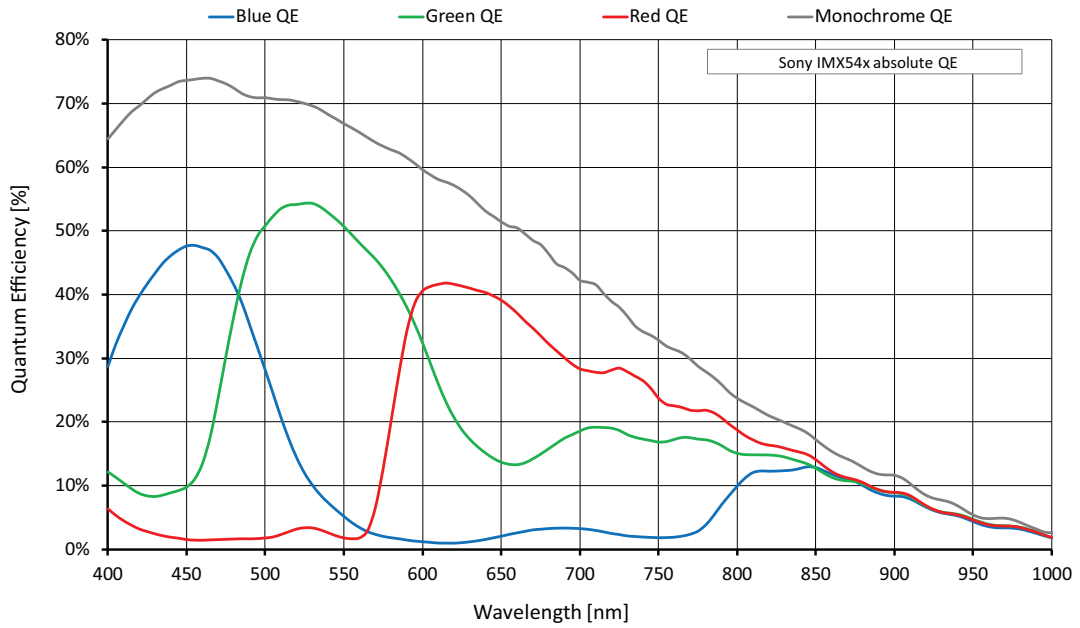

Figure 34: Alvium G1-1620m/c (Sony IMX542) absolute QE

Spectral response

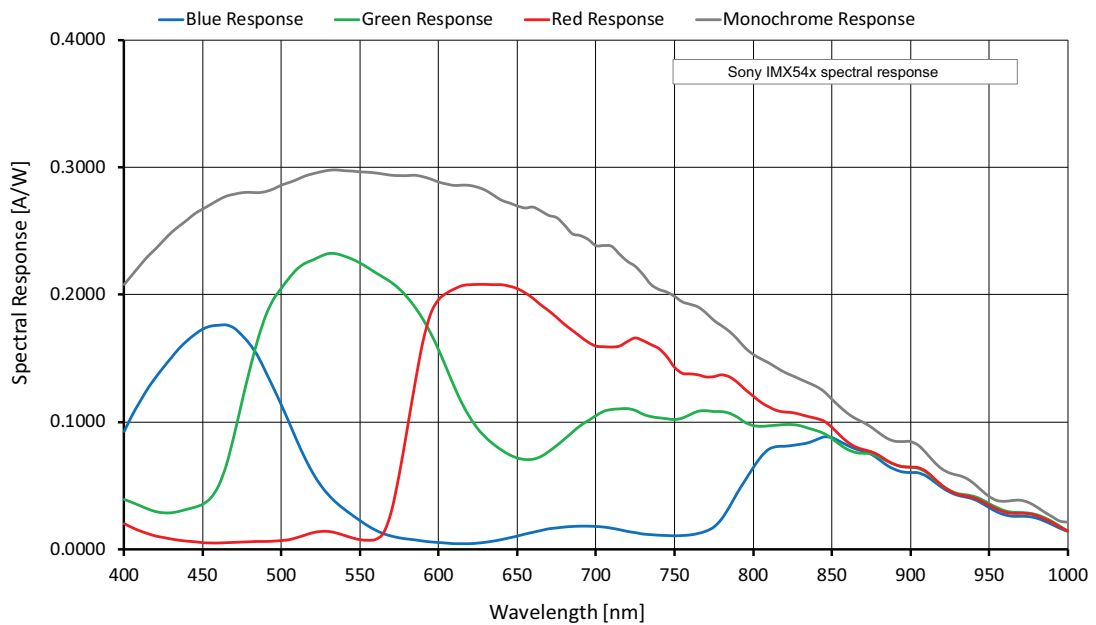

Figure 35: Alvium G1-1620m/c (Sony IMX542) spectral response

ROI frame rates

Values are based on the conditions defined in [Specified values](#) on page 59.

Currently, Alvium G1-1620 models can be operated only at 122 MByte/s.

Image format	Width [pixels]	Height [pixels]	ROI area [MP]	Frame rate [fps] ¹
				122 MByte/s
Full resolution	5328	3040	16.197	7.3/3.7
UHD 4K	3840	2160	8.294	14.3/7.1
QSXGA	2560	2048	5.243	22.6/11.3
WQHD	2560	1440	3.686	32.1/16.1
QXGA	2048	1536	3.146	37.6/18.8
Full HD	1920	1080	2.074	57.0/28.5
UXGA	1600	1200	1.92	51.9/30.8
WXGA+	1440	900	1.296	67.0/45.7
SXGA	1280	1024	1.311	60.0/45.1
HD 720	1280	720	0.922	81.7/64.2
XGA	1024	768	0.786	77.5/75.2
SVGA	800	600	0.48	95.9/95.9
VGA	640	480	0.307	115.5/115.4
HVGA	480	320	0.154	158.0/158.0
QVGA	320	240	0.077	193.7/193.7
HQVGA	240	160	0.038	250.0/250.0
QQVGA	160	120	0.019	292.5/292.6
Max. × half	5328	1520	8.099	14.6/7.3
Max. × min.	5328	8	0.043	343.5/194.6
Min. × max.	8	3040	0.024	21.8/21.8
Min. × min.	8	8	64 P	558.9/558.9

¹ Mono8 or Bayer...8⁽²⁾ at SensorBitDepth = 12-Bit /
Mono12 or Bayer...12 at SensorBitDepth = 12-Bit

² The three dots... represent the colors of a Bayer pixel format, such as in BayerRG8.

Table 61: Alvium G1-1620m/c ROI frame rates

Alvium G1-2040m/c

Feature	Specification	
	G1-2040m (monochrome)	G1-2040c (color)
Sensor model	Sony IMX541	
Resolution	4512 (H) × 4512 (V); 20.4 MP	
Sensor type	CMOS	
Shutter type	Global shutter (GS)	
Sensor size	Type 1.1; 12.4 mm × 12.4 mm; 17.5 mm diagonal	
Pixel size	2.74 μm × 2.74 μm	
CRA	0 deg	
Sensor bit depth (ADC)	12-bit	
Monochrome pixel formats	Mono8 (default), Mono10, Mono10p, Mono12, Mono12p, Mono12Packed	Mono8, Mono10, Mono10p, Mono12, Mono12p, Mono12Packed
YUV color pixel formats	Not applicable	YCbCr411_8_CbYYCrYY, YCbCr422_8_CbYCrY, YCbCr8_CbYCr
RGB color pixel formats	Not applicable	BGR8, RGB8 (default)
Raw color pixel formats	Not applicable	BayerRG8, BayerRG10, BayerRG10p, BayerRG12, BayerRG12p, BayerRG12Packed
Maximum frame rate	5.8 fps (at 122 MByte/s)	
Exposure time	40 μs to 10 s (at 122 MByte/s)	
Exposure modes	Timed, TriggerControlled, TriggerWidth	
Gain	0 dB to 48 dB; 0.1 dB increments	
Digital binning ¹	Horizontal: 1 to 8 columns; Vertical: 1 to 8 rows	
Sensor binning (H × V)	2 × 2 (<i>Sum</i>)	Not applicable
Multiple ROI (H × V)	<i>Free</i> <i>Tile</i> <i>Horizontal</i> : 1 × 1 to 1 × 4 <i>Vertical</i> : 1 × 1 to 4 × 1	
Image buffer (RAM)	32 MByte	
Non-volatile memory (Flash)	1024 KByte	
Inputs and outputs	1 opto-isolated input, 1 opto-isolated output, 2 non-isolated GPIOs ²	

¹ Digital vertical binning can be used only when digital horizontal binning is used as well.

² Use with external power only, not with PoE. See [I/Os and power supply by PoE](#) on page 50.

Table 62: Alvium G1-2040m/c specifications (sheet 1 of 2)

Feature	Specification			
Power requirements	12 to 24 VDC			
Power requirements (PoE)	IEEE 802.3af			
Power consumption (typical)	External power: 3.8 W at 12 VDC Power over Ethernet: 4.2 W			
Storage temperature	-20 °C to +85 °C ambient temperature			
Operating temperature	Hardware option	Housing³	Cooling area⁴	Mainboard⁵
	G1 BL No Mount ⁶	-20 °C to +65 °C	-20 °C to +85 °C	-20 °C to +85 °C
	G1 BL with mount ⁷	-20 °C to +65 °C	-20 °C to +85 °C	
	Closed Housing	-20 °C to +65 °C	Not applicable	
Relative humidity	0% to 80% (non-condensing)			
Digital interface	1000BASE-T			
Camera controls	GenICam (GenICam Access)			

³ Including the interface unit for G1 BL models

⁴ See [Heat dissipation for Alvium G1 BL](#) on page 192 and [Mounting the G1 BL interface unit](#) on page 201.

⁵ Output by DeviceTemperature

⁶ Ensure that the sensor is operated in the temperature range specified by the manufacturer. For any questions, please visit www.alliedvision.com/en/support.

Housing temperature applies to the interface unit only.

⁷ Temperature values must be observed for the housing **and** for the cooling areas.

Table 62: Alvium G1-2040m/c specifications (sheet 2 of 2)

Absolute QE

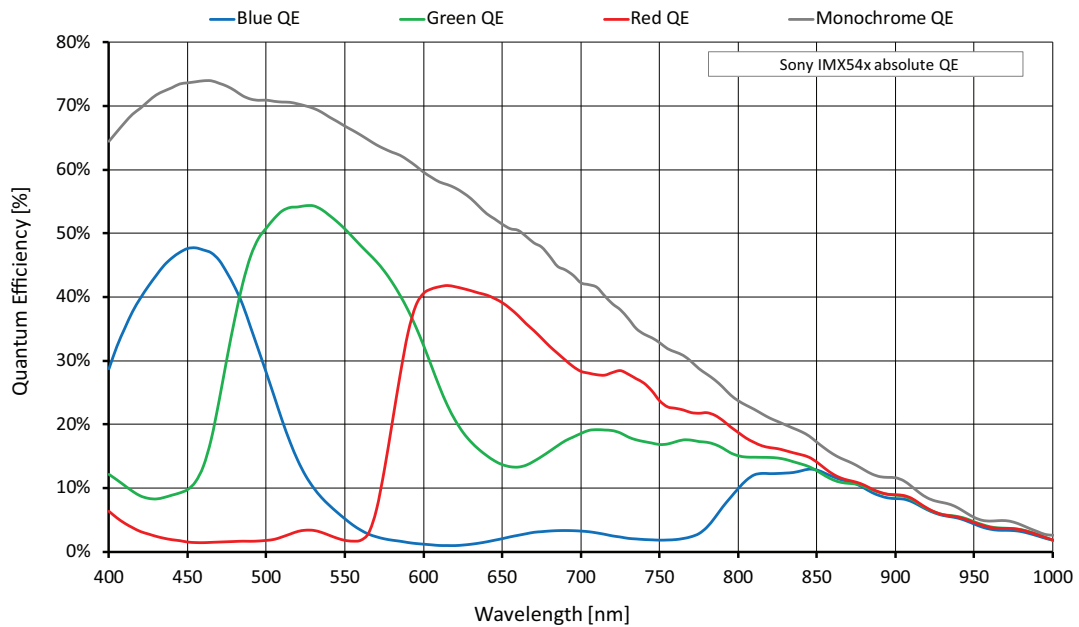

Figure 36: Alvium G1-2040m/c (Sony IMX541) absolute QE

Spectral response

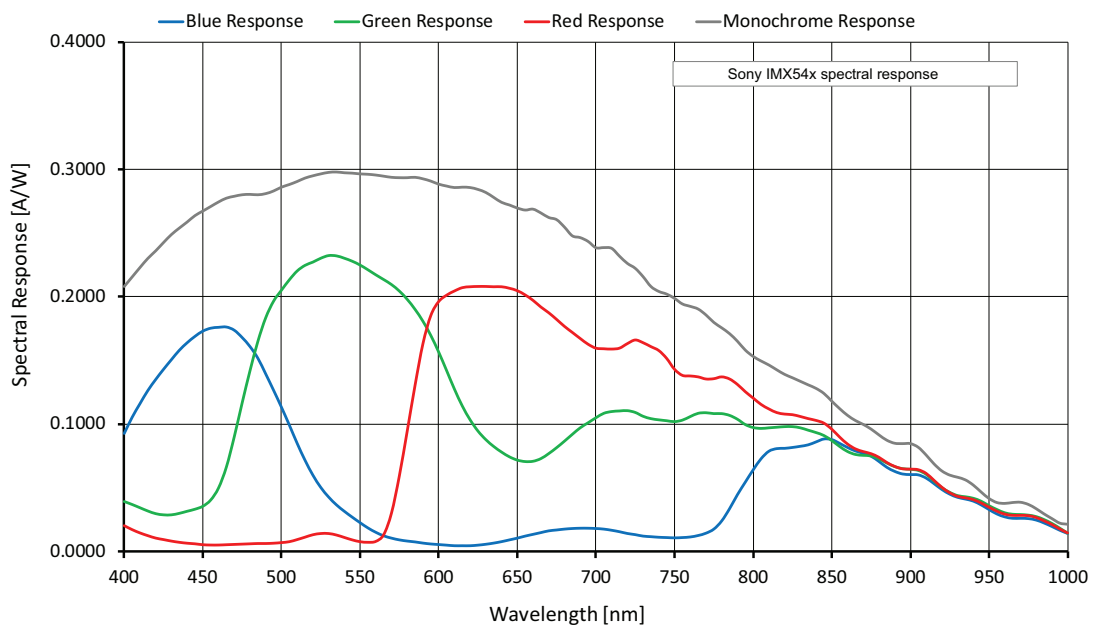

Figure 37: Alvium G1-2040m/c (Sony IMX541) spectral response

ROI frame rates

Values are based on the conditions defined in [Specified values](#) on page 59.

Currently, Alvium G1-2040 models can be operated only at 122 MByte/s.

Image format	Width [pixels]	Height [pixels]	ROI area [MP]	Frame rate [fps] ¹
				122 MByte/s
Full resolution	4512	4512	20.358	5.8/2.9
HXGA	4096	3072	12.583	9.4/4.7
UHD 4K	3840	2160	8.294	14.3/7.1
QSXGA	2560	2048	5.243	22.6/11.3
WQHD	2560	1440	3.686	32.1/16.1
QXGA	2048	1536	3.146	37.6/18.8
Full HD	1920	1080	2.074	57.1/28.5
UXGA	1600	1200	1.92	60.8/30.8
WXGA+	1440	900	1.296	78.3/45.6
SXGA	1280	1024	1.311	70.3/45.1
HD 720	1280	720	0.922	95.5/64.2
XGA	1024	768	0.786	90.7/75.2
SVGA	800	600	0.48	112.0/112.0
VGA	640	480	0.307	134.8/134.6
HVGA	480	320	0.154	183.8/183.8
QVGA	320	240	0.077	224.7/224.7
HQVGA	240	160	0.038	288.9/288.9
QQVGA	160	120	0.019	337.0/337.0
Max. × half	4512	2256	10.179	11.6/5.8
Max. × min.	4512	8	0.036	392.1/223.1
Min. × max.	8	4512	0.036	17.5/17.5
Min. × min.	8	8	64 P	631.9/631.9

¹ Mono8 or Bayer...g⁽²⁾ at SensorBitDepth = 12-Bit /
Mono12 or Bayer...12 at SensorBitDepth = 12-Bit

² The three dots... represent the colors of a Bayer pixel format, such as in BayerRG8.

Table 63: Alvium G1-2040m/c ROI frame rates

Alvium G1-2050m/c

Feature	Specification	
	G1-2050m (monochrome)	G1-2050c (color)
Sensor model	Sony IMX183	
Resolution	5496 (H) × 3672 (V); 20.2 MP	
Sensor type	CMOS	
Shutter type	Rolling shutter (RS), Global reset shutter (GRS)	
Sensor size	Type 1; 13.1 mm × 8.8 mm; 15.9 mm diagonal	
Pixel size	2.4 μm × 2.4 μm	
CRA	3 deg	
Sensor bit depth (ADC)	10-bit	
Monochrome pixel formats	Mono8 (default), Mono10, Mono10p, Mono12, Mono12p, Mono12Packed	Mono8, Mono10, Mono10p, Mono12, Mono12p, Mono12Packed
YUV color pixel formats	Not applicable	YCbCr411_8_CbYYCrYY, YCbCr422_8_CbYCrY, YCbCr8_CbYCr
RGB color pixel formats	Not applicable	BGR8, RGB8 (default)
Raw color pixel formats	Not applicable	BayerRG8, BayerRG10, BayerRG10p, BayerRG12, BayerRG12p, BayerRG12Packed
Maximum frame rate ¹	5.9 fps (at 122 MByte/s)	
Exposure time	48 μs to 10 s (at 122 MByte/s)	
Exposure modes	Timed	
Gain	0 dB to 27 dB; 0.1 dB increments	
Digital binning ²	Horizontal: 1 to 8 columns; Vertical: 1 to 8 rows	
Image buffer (RAM)	32 MByte	
Non-volatile memory (Flash)	1024 KByte	
Inputs and outputs	1 opto-isolated input, 1 opto-isolated output, 2 non-isolated GPIOs ³	
Power requirements	12 to 24 VDC	
Power requirements (PoE)	IEEE 802.3af	

¹ In triggered mode: ~5.9 fps

² Digital vertical binning can be used only when digital horizontal binning is used as well.

³ Use with external power only, not with PoE. See [I/Os and power supply by PoE](#) on page 50.

Table 64: Alvium G1-2050m/c specifications (sheet 1 of 2)

Feature	Specification			
Power consumption (typical)	External power: 3.6 W at 12 VDC Power over Ethernet: 3.9 W			
Storage temperature	-20 °C to +85 °C ambient temperature			
Operating temperature	Hardware option	Housing⁴	Cooling area⁵	Mainboard⁶
	G1 BL No Mount ⁷	-20 °C to +65 °C	-20 °C to +85 °C	-20 °C to +88 °C
	G1 BL with mount ⁸	-20 °C to +65 °C	-20 °C to +85 °C	
	Closed Housing	-20 °C to +65 °C	Not applicable	
Relative humidity	0% to 80% (non-condensing)			
Digital interface	1000BASE-T			
Camera controls	GenICam (GenICam Access)			

⁴ Including the interface unit for G1 BL models

⁵ See [Heat dissipation for Alvium G1 BL](#) on page 192 and [Mounting the G1 BL interface unit](#) on page 201.

⁶ Output by `DeviceTemperature`

⁷ Ensure that the sensor is operated in the temperature range specified by the manufacturer. For any questions, please visit www.alliedvision.com/en/support.

Housing temperature applies to the interface unit only.

⁸ Temperature values must be observed for the housing **and** for the cooling areas.

Table 64: Alvium G1-2050m/c specifications (sheet 2 of 2)

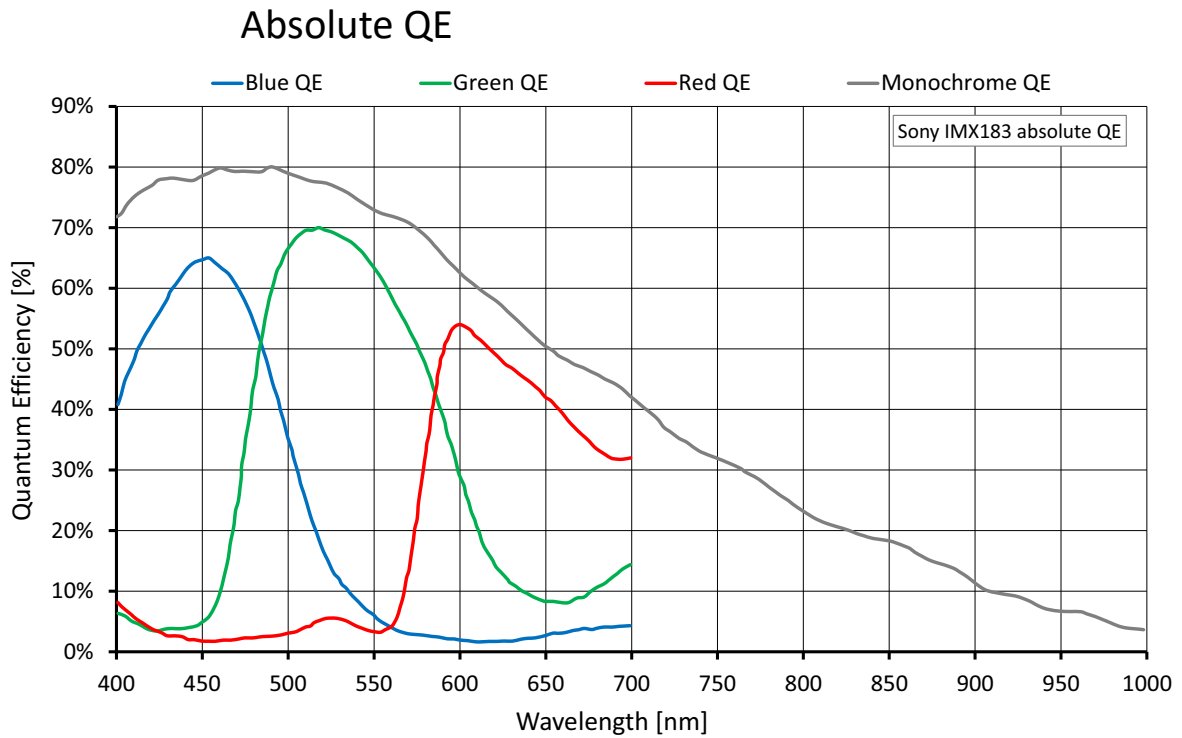

Figure 38: Alvium G1-2050m/c (Sony IMX183) absolute QE

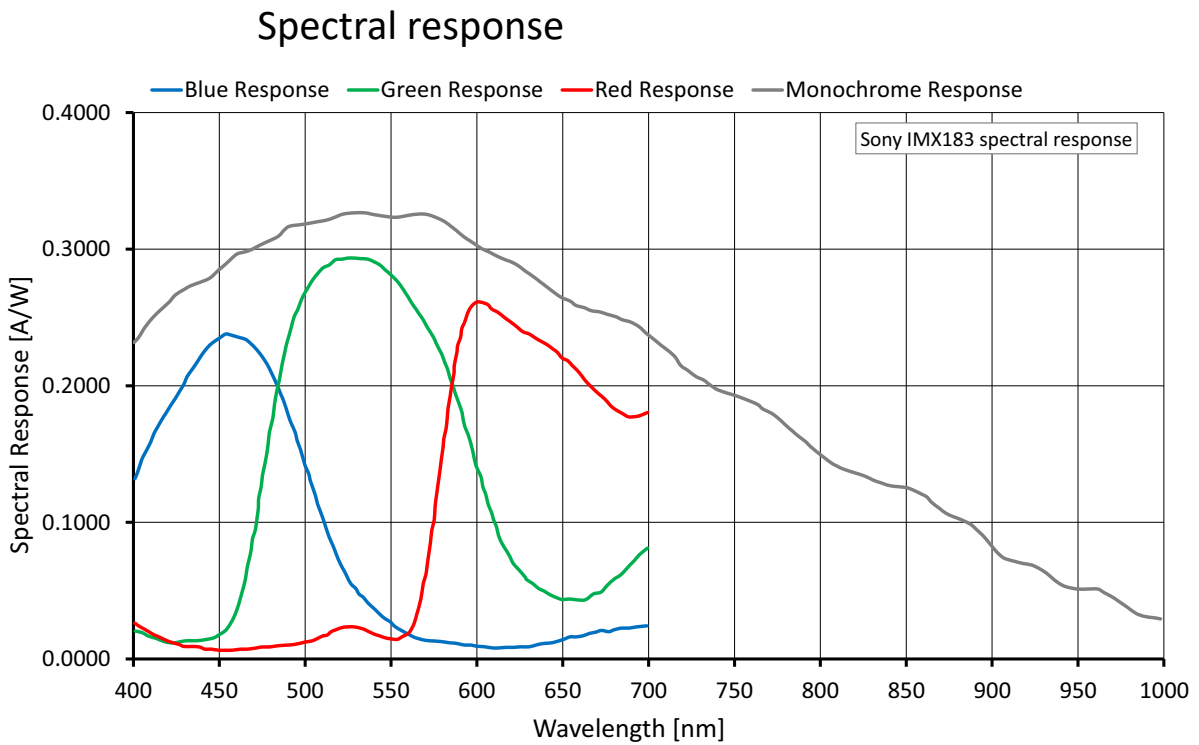

Figure 39: Alvium G1-2050m/c (Sony IMX183) spectral response

ROI frame rates

Values are based on the conditions defined in [Specified values](#) on page 59.

Shutter mode	User mode	Available frame rates
Rolling shutter (RS)	Freerun	Values in Table 66 below are reached.
Rolling shutter (RS)	Triggered	>99% of the values for in Table 66 below are reached.
Global reset shutter (GRS)	Freerun	>99% of the values for in Table 66 below are reached.
Global reset shutter (GRS)	Triggered	

Table 65: Frame rate behavior for different configurations

Currently, Alvium G1-2050 models can be operated only at 122 MByte/s.

Image format	Width [pixels]	Height [pixels]	ROI area [MP]	Frame rate [fps] ¹
				122 MByte/s
Full resolution	5496	3672	20.181	5.9/2.9
HXGA	4096	3072	12.583	9.4/4.7
UHD 4K	3840	2160	8.294	14.3/7.1
QSXGA	2560	2048	5.243	19.1/9.6
WQHD	2560	1440	3.686	21.0/10.6
QXGA	2048	1536	3.146	21.0/10.6
Full HD	1920	1080	2.074	21.0/10.6
UXGA	1600	1200	1.92	21.0/10.6
WXGA+	1440	900	1.296	21.0/10.6
SXGA	1280	1024	1.311	21.0/10.6
HD 720	1280	720	0.922	21.0/10.6
XGA	1024	768	0.786	21.0/10.6
SVGA	800	600	0.48	21.0/10.6
VGA	640	480	0.307	21.0/10.6
HVGA	480	320	0.154	21.0/10.6
QVGA	320	240	0.077	21.0/10.6
HQVGA	240	160	0.038	21.0/10.6
QQVGA	160	120	0.019	21.0/10.6
Max. × half	5496	1836	10.091	11.7/5.9
Max. × min.	5496	8	0.044	21.0/10.6
Min. × max.	8	3672	0.029	10.8/5.4
Min. × min.	8	8	64 P	20.0/10.6

¹ Mono8 or Bayer...g⁽²⁾ at SensorBitDepth = 10-Bit / Mono10 or Bayer...10 at SensorBitDepth = 10-Bit

² The three dots... represent the colors of a Bayer pixel format, such as in BayerRG8.

Table 66: Alvium G1-2050m/c ROI frame rates

Alvium G1-2460m/c

Feature	Specification	
	G1-2460m (monochrome)	G1-2460c (color)
Sensor model	Sony IMX540	
Resolution	5328 (H) × 4608 (V); 24.6 MP	
Sensor type	CMOS	
Shutter type	Global shutter (GS)	
Sensor size	Type 1.2; 14.6 mm × 12.6 mm; 19.3 mm diagonal	
Pixel size	2.74 μm × 2.74 μm	
CRA	0 deg	
Sensor bit depth (ADC)	12-bit	
Monochrome pixel formats	Mono8 (default), Mono10, Mono10p, Mono12, Mono12p, Mono12Packed	Mono8, Mono10, Mono10p, Mono12, Mono12p, Mono12Packed
YUV color pixel formats	Not applicable	YCbCr411_8_CbYYCrYY, YCbCr422_8_CbYCrY, YCbCr8_CbYCr
RGB color pixel formats	Not applicable	BGR8, RGB8 (default)
Raw color pixel formats	Not applicable	BayerRG8, BayerRG10, BayerRG10p, BayerRG12, BayerRG12p, BayerRG12Packed
Maximum frame rate	4.8 fps (at 122 MByte/s)	
Exposure time	47 μs to 10 s (at 122 MByte/s)	
Exposure modes	Timed, TriggerControlled, TriggerWidth	
Gain	0 dB to 48 dB; 0.1 dB increments	
Digital binning ¹	Horizontal: 1 to 8 columns; Vertical: 1 to 8 rows	
Sensor binning (H × V)	2 × 2 (<i>Sum</i>)	Not applicable
Multiple ROI (H × V)	<i>Free</i> <i>Tile</i> <i>Horizontal</i> : 1 × 1 to 1 × 4 <i>Vertical</i> : 1 × 1 to 4 × 1	
Image buffer (RAM)	32 MByte	
Non-volatile memory (Flash)	1024 KByte	
Inputs and outputs	1 opto-isolated input, 1 opto-isolated output, 2 non-isolated GPIOs ²	
Power requirements	12 to 24 VDC	
Power requirements (PoE)	IEEE 802.3af	

¹ Digital vertical binning can be used only when digital horizontal binning is used as well.

² Use with external power only, not with PoE. See [I/Os and power supply by PoE](#) on page 50.

Table 67: Alvium G1-2460m/c specifications (sheet 1 of 2)

Feature	Specification			
Power consumption (typical) ³	External power: 4.0 W at 12 VDC Power over Ethernet: 4.4 W			
Storage temperature	-20 °C to +85 °C ambient temperature			
Operating temperature	Hardware option	Housing³	Cooling area⁴	Mainboard⁵
	G1 BL No Mount ⁶	-20 °C to +65 °C	-20 °C to +85 °C	-20 °C to +85 °C
	G1 BL with mount ⁷	-20 °C to +65 °C	-20 °C to +85 °C	
	Closed Housing	-20 °C to +65 °C	Not applicable	
Relative humidity	0% to 80% (non-condensing)			
Digital interface	1000BASE-T			
Camera controls	GenICam (GenICam Access)			

³ Including the interface unit for G1 BL models

⁴ See [Heat dissipation for Alvium G1 BL](#) on page 192 and [Mounting the G1 BL interface unit](#) on page 201.

⁵ Output by `DeviceTemperature`

⁶ Ensure that the sensor is operated in the temperature range specified by the manufacturer. For any questions, please visit www.alliedvision.com/en/support.

Housing temperature applies to the interface unit only.

⁷ Temperature values must be observed for the housing **and** for the cooling areas.

Table 67: Alvium G1-2460m/c specifications (sheet 2 of 2)

Absolute QE

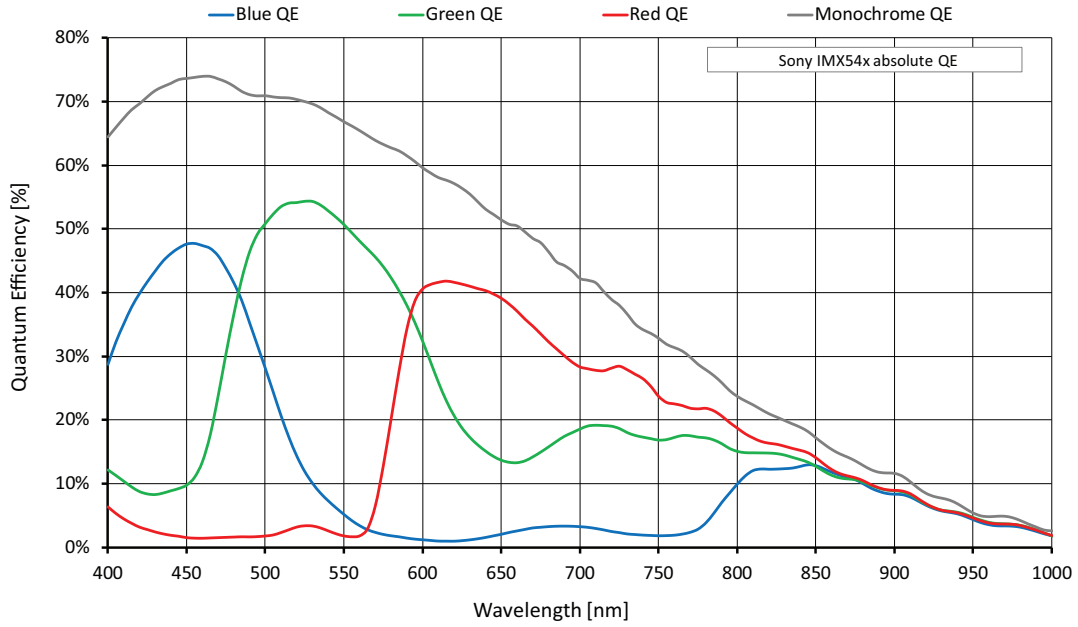

Figure 40: Alvium G1-2460m/c (Sony IMX540) absolute QE

Spectral response

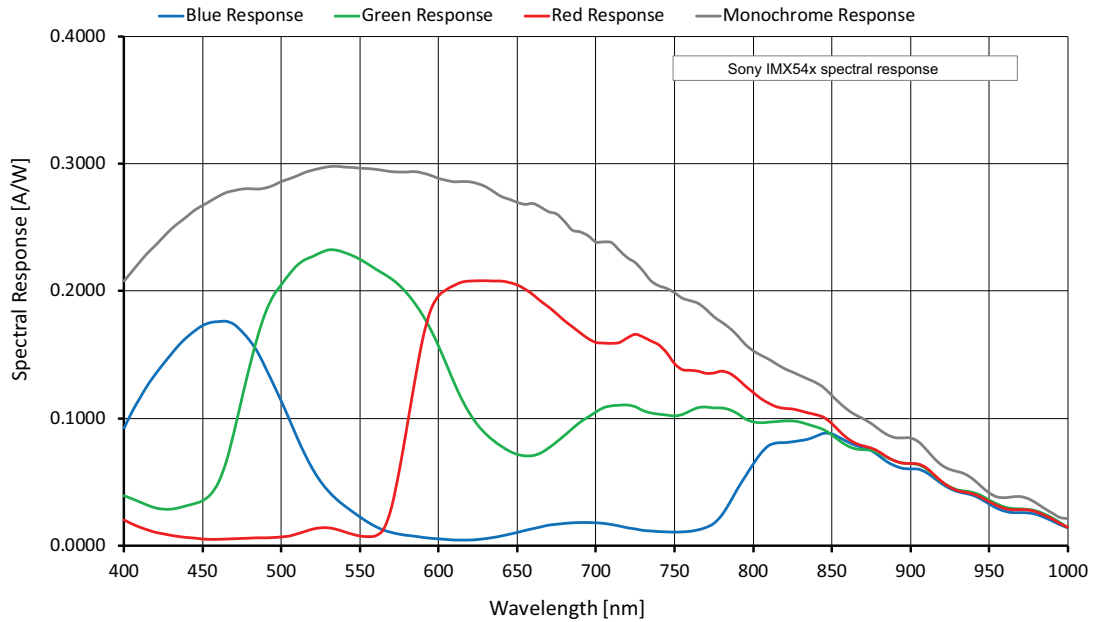

Figure 41: Alvium G1-2460m/c (Sony IMX540) spectral response

ROI frame rates

Values are based on the conditions defined in [Specified values](#) on page 59.

Currently, Alvium G1-2460 models can be operated only at 122 MByte/s.

Image format	Width [pixels]	Height [pixels]	ROI area [MP]	Frame rate [fps] ¹
				122 MByte/s
Full resolution	5328	4608	24.551	4.8/2.4
HSXGA	5120	4096	20.972	5.6/2.8
HXGA	4096	3072	12.583	9.4/4.7
UHD 4K	3840	2160	8.294	14.3/7.1
QSXGA	2560	2048	5.243	22.6/11.3
WQHD	2560	1440	3.686	32.1/16.1
QXGA	2048	1536	3.146	37.6/18.8
Full HD	1920	1080	2.074	57.0/28.5
UXGA	1600	1200	1.92	51.9/30.8
WXGA+	1440	900	1.296	67.0/45.7
SXGA	1280	1024	1.311	60.0/45.1
HD 720	1280	720	0.922	81.7/64.2
XGA	1024	768	0.786	77.5/75.2
SVGA	800	600	0.48	95.9/95.9
VGA	640	480	0.307	115.5/115.4
HVGA	480	320	0.154	158.0/158.0
QVGA	320	240	0.077	193.7/193.7
HQVGA	240	160	0.038	250.0/250.0
QQVGA	160	120	0.019	292.5/292.6
Max. × half	5328	2304	12.276	9.6/4.8
Max. × min.	5328	8	0.043	343.5/194.6
Min. × max.	8	4608	0.037	14.6/14.6
Min. × min.	8	8	64 P	558.9/558.9

¹ Mono8 or Bayer...8⁽²⁾ at SensorBitDepth = 10-Bit /
Mono10 or Bayer...10 at SensorBitDepth = 10-Bit

² The three dots... represent the colors of a Bayer pixel format, such as in BayerRG8.

Table 68: Alvium G1-2460m/c ROI frame rates

White balance default

Alvium G1 color cameras are balanced for neutral color reproduction with an illumination of 5000 °K (warm daylight). [Table 69](#) shows default values for the red and blue channel by model.

For different illuminations, use auto white balance or adapt the color channel values manually.



Feature descriptions and firmware downloads

Alvium Features Reference: www.alliedvision.com/en/support/technical-documentation/alvium-gige-documentation

Firmware downloads: www.alliedvision.com/en/support/firmware-downloads.

Alvium G1 model	Sensor model	Red channel value	Blue channel value
Alvium G1-040c	Sony IMX287	2.360	2.030
Alvium G1-131c	e2v EV76C560	Tbd	Tbd
Alvium G1-158c	Sony IMX273	2.355	2.100
Alvium G1-192c	e2v EV76C570	Tbd	Tbd
Alvium G1-234c	Sony IMX249	2.580	1.810
Alvium G1-240c	Sony IMX392	2.355	2.100
Alvium G1-319c	Sony IMX265	2.355	2.100
Alvium G1-500c	ON Semiconductor AR0521SR	2.120	1.520
Alvium G1-507c	Sony IMX264	2.355	2.100
Alvium G1-507c Pol	Sony IMX264MYR	Not applicable	
Alvium G1-510c	Sony IMX548	2.870	2.000
Alvium G1-811c	Sony IMX546	2.870	2.000
Alvium G1-895c	Sony IMX267	2.355	2.100
Alvium G1-1236c	Sony IMX304	2.355	2.100
Alvium G1-1240c	Sony IMX226	2.620	1.810
Alvium G1-1242c	Sony IMX545	2.870	2.000
Alvium G1-1620c	Sony IMX542	2.870	2.000
Alvium G1-2040c	Sony IMX541	2.870	2.000
Alvium G1-2050c	Sony IMX183	2.660	1.830
Alvium G1-2460c	Sony IMX540	2.870	2.000

Table 69: Alvium G1 default values for color channels



Excluded models

White balance default does not apply to monochrome and Pol models.

G1 Closed Housing: Dimensions and mass

Feature	C-Mount	CS-Mount	S-Mount
Flange focal distance, optical [mm]	17.526	12.526	12.63
Thread [mm]	1"-32tpi UNS-2B	1"-32tpi UNS-2B	M12 × 0.5
Maximum protrusion ¹ [mm]	13.6	8.6	11.0
Body dimensions (L × W × H [mm])	41 × 29 × 29	36 × 29 × 29	36 × 29 × 29
Mass	70 g	70 g	70 g

¹For details, see [Lens mounts and maximum protrusion..](#)

Table 70: Standard Alvium G1 housing dimensions and mass

G1 Closed Housing: Technical drawings

Standard Alvium G1 cameras are available with the following housing options:

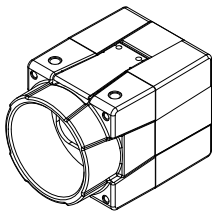
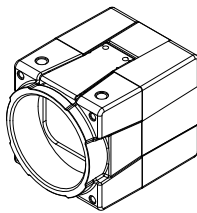
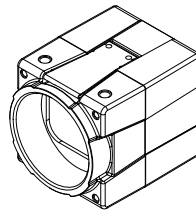
			
Option	Closed Housing C-Mount	Closed Housing CS-Mount	Closed Housing S-Mount
Page	156	157	157

G1 Closed Housing C-Mount

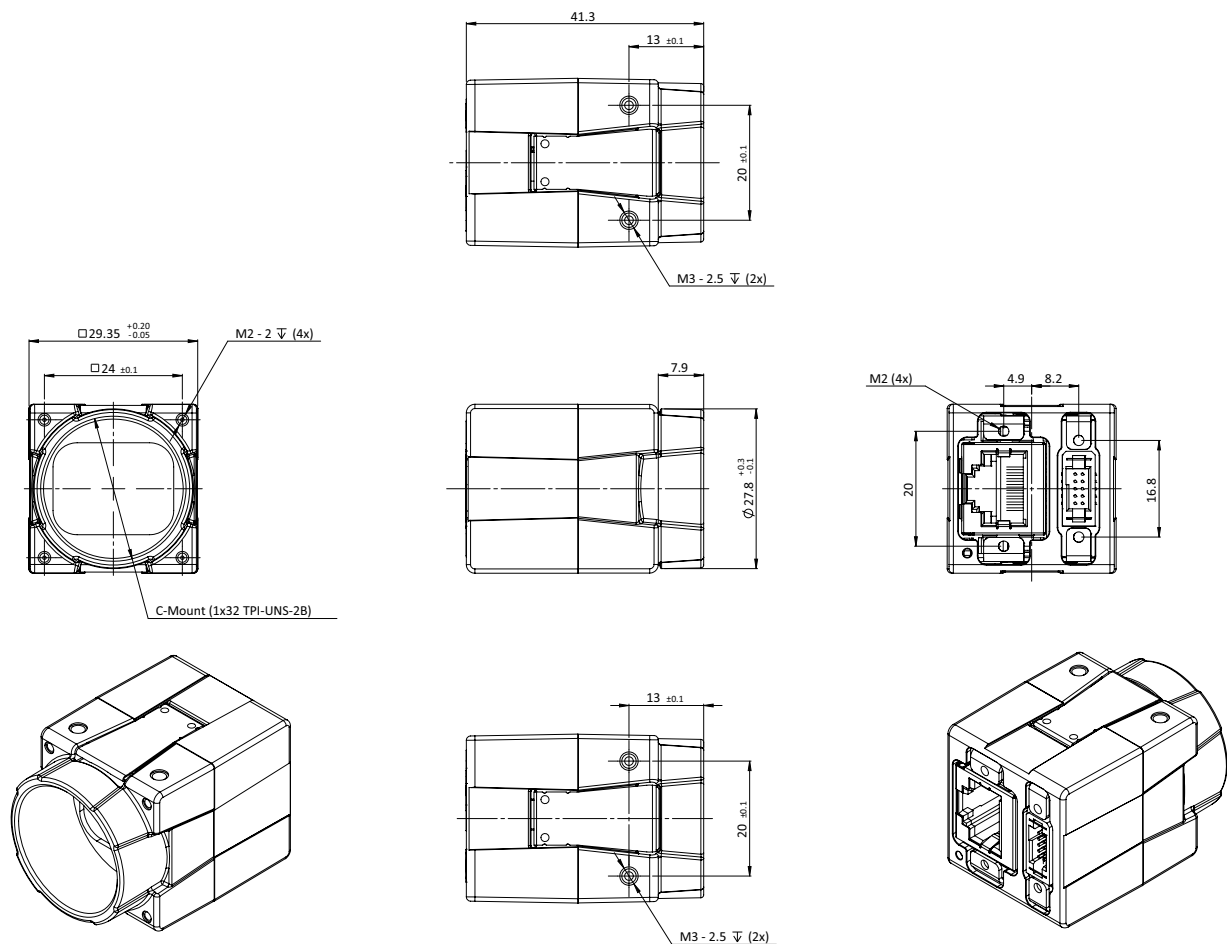

Figure 42: G1 Closed Housing C-Mount dimensions

G1 Closed Housing CS-Mount

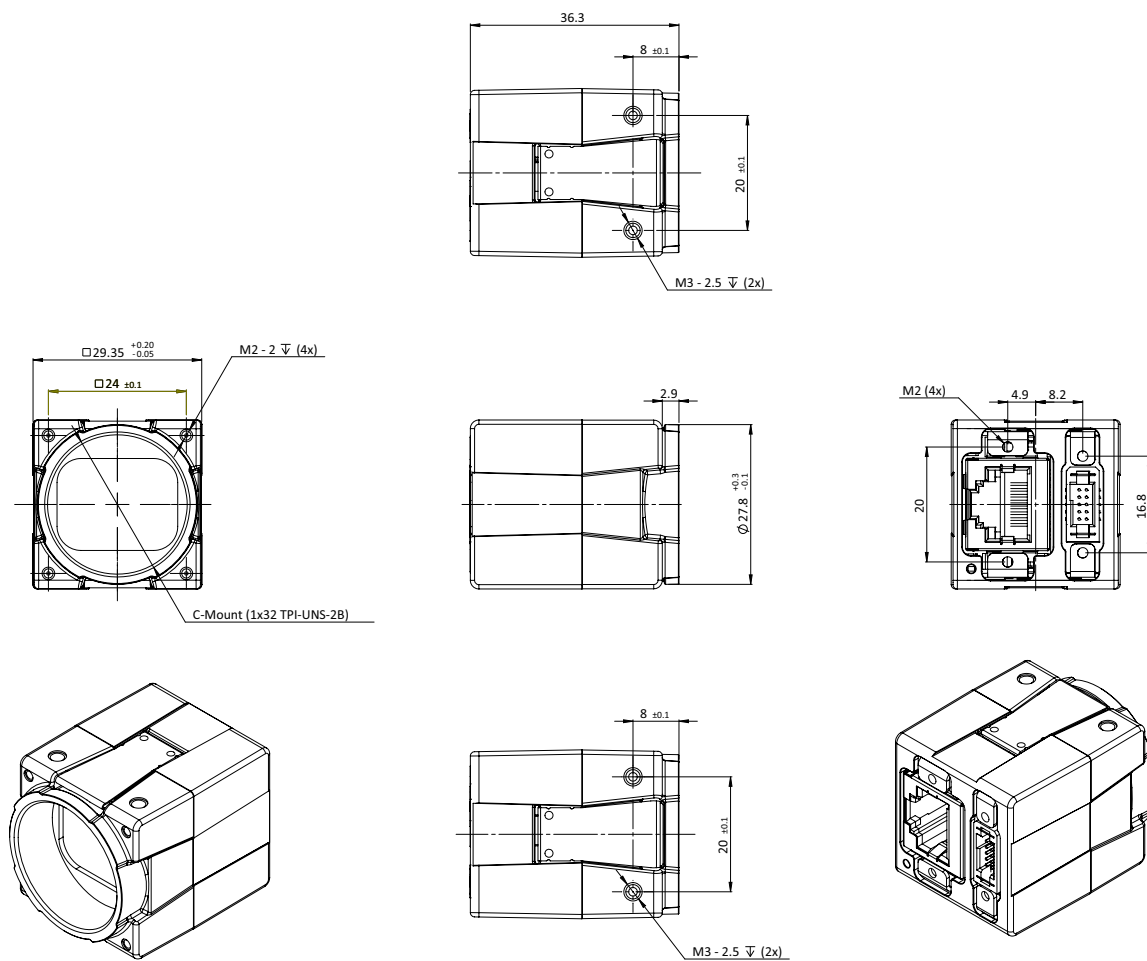

Figure 43: G1 Closed Housing CS-Mount dimensions

G1 Closed Housing S-Mount

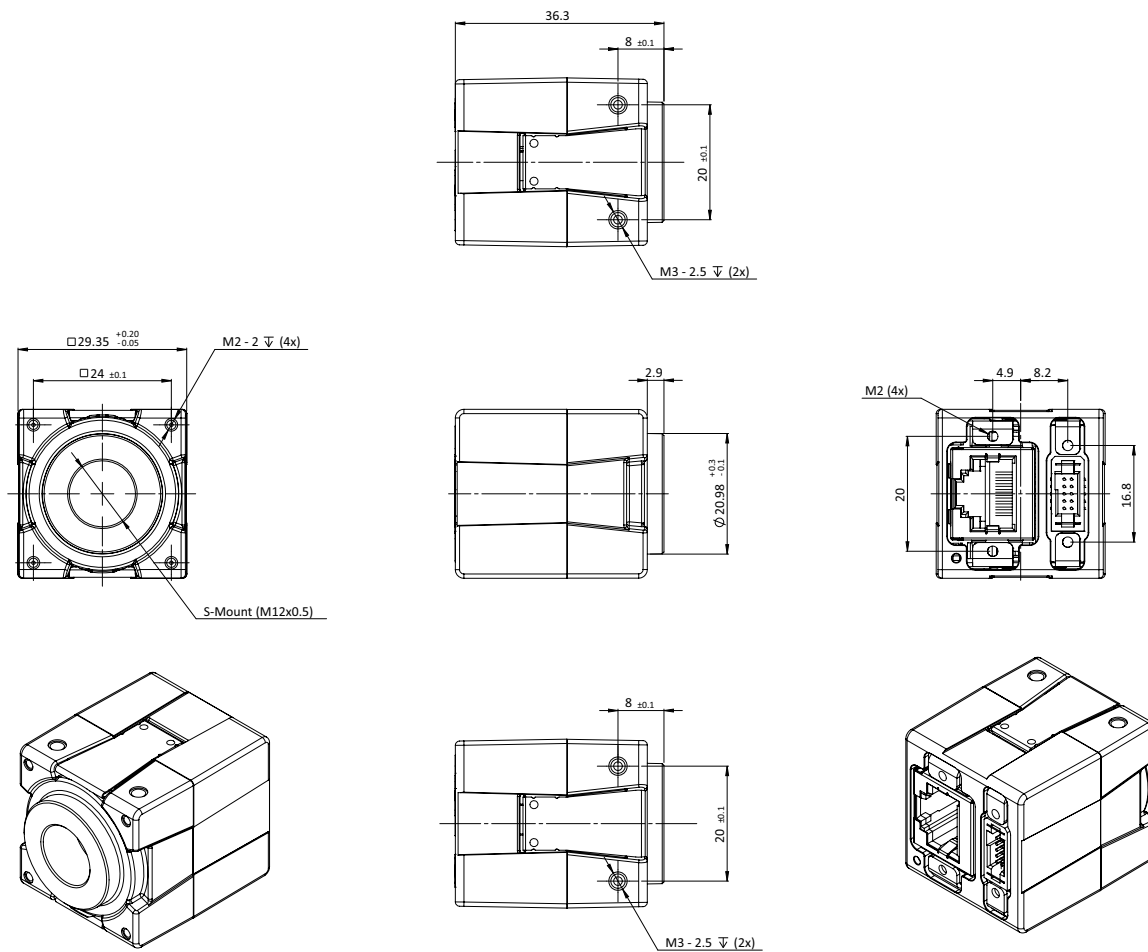

Figure 44: G1 Closed Housing S-Mount dimensions

Alvium G1 BL: Dimensions and mass

G1 BL with mount

Feature	Sensor unit specifications			Interface unit specifications
	C-Mount	CS-Mount	S-Mount	
Flange focal distance, optical	17.526 mm	12.526 mm	12.63 mm	N.a.
Thread	1"-32tpi UNS-2B	1"-32tpi UNS-2B	M12 mm × 0.5 mm	N.a.
Maximum protrusion ¹	13.6 mm	8.6 mm	11.0 mm	N.a.
Body dimensions (L × W × H) in [mm]	25 × 29 × 29	20 × 29 × 29	20 × 29 × 29	22 × 39 × 27
Mass	40 g	40 g	40 g	30 g

¹For details, see [Lens mounts and maximum protrusion..](#)

Table 71: G1 BL cameras with mount dimensions and mass

G1 BL Frame

Feature	Sensor unit specifications	Interface unit specifications
Flange focal distance, optical	3.576 mm	Not applicable
Front hole diameter	24.5 mm	Not applicable
Maximum protrusion ¹	1.5 mm	Not applicable
Body dimensions (L × W × H) in [mm]	10.1 × 29 × 29	22 mm × 39 mm × 27 mm
Mass	15 g	30 g

¹For details, see [Maximum protrusion](#) on page 52.

Table 72: G1 BL Frame cameras with mount dimensions and mass

G1 BL No Mount

Feature	Sensor unit specifications	Interface unit specifications
Dimensions (L × W × H)	[Model specific] × 26 mm × 26 mm	22 mm × 39 mm × 27 mm
Mass [g]	10 g	30 g

Table 73: G1 BL No Mount dimensions and mass

Alvium G1 BL: Technical drawings

Alvium G1 BL cameras compose of the sensor unit and the interface unit:

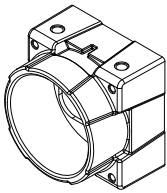
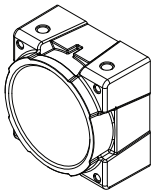
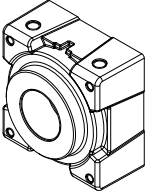
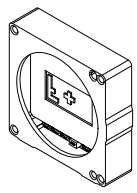
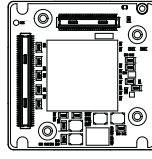
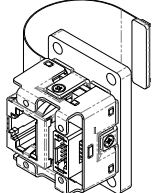
	Sensor unit				Interface unit	
						
Option	C-Mount	CS-Mount	S-Mount	Frame	No Mount	Add for all options
Page	160	161	162	163	164	166

Alvium G1 BL C-Mount

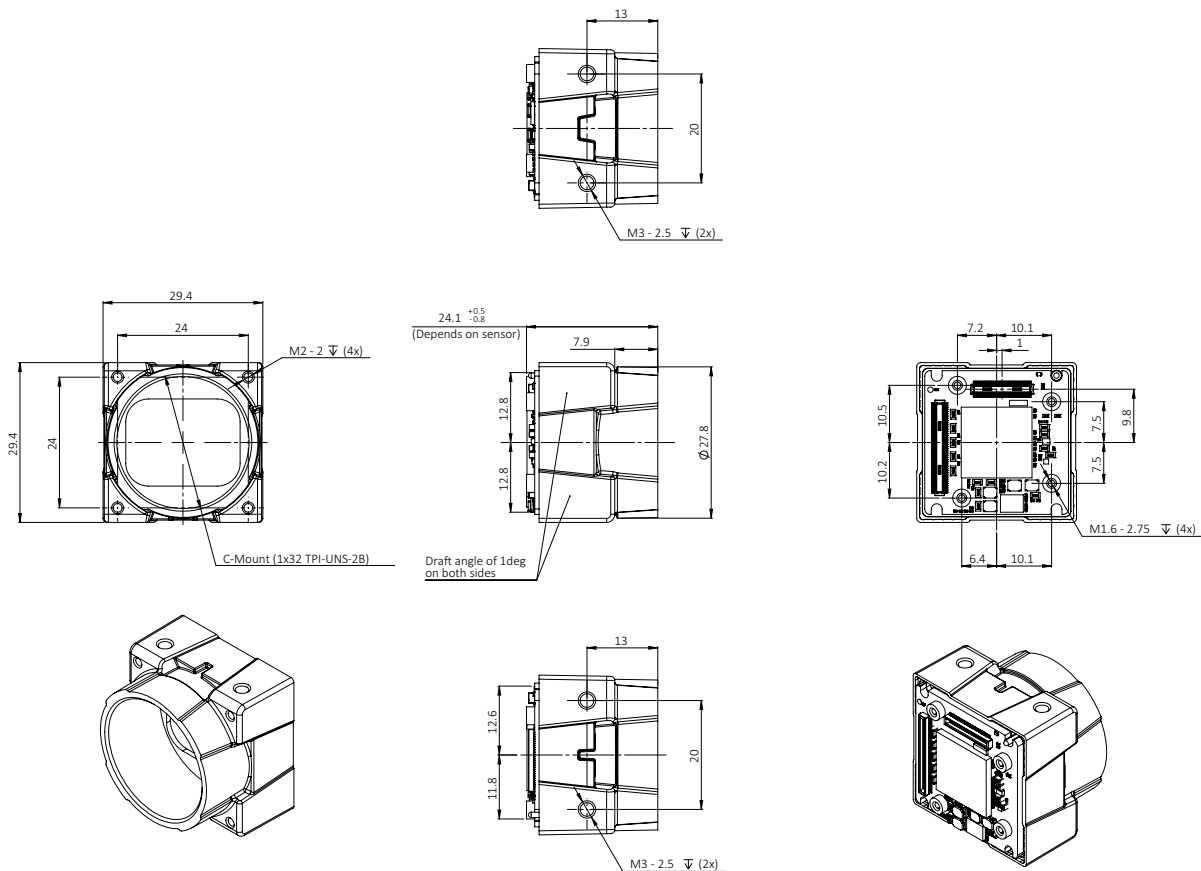

Figure 45: Alvium G1 BL C-Mount dimensions

Alvium G1 BL CS-Mount

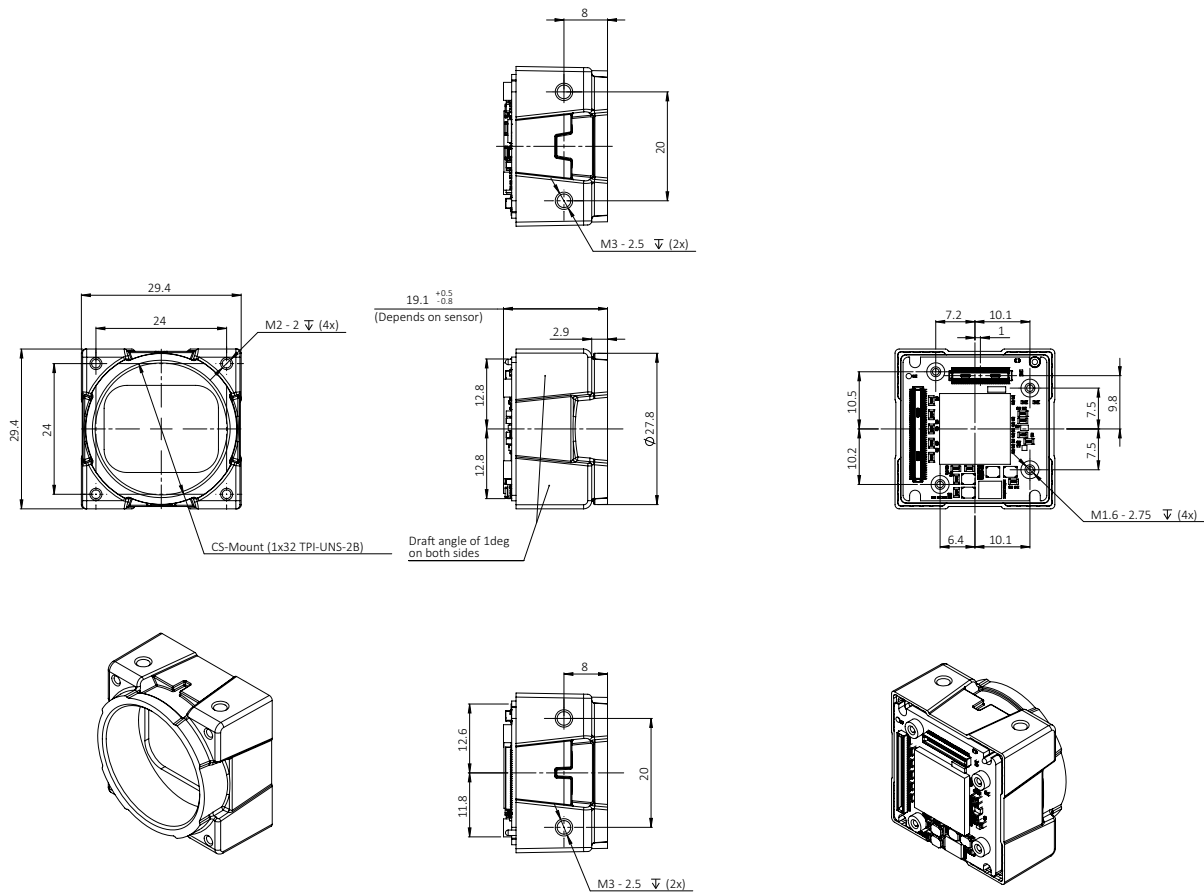

Figure 46: Alvium G1 BL CS-Mount dimensions

Alvium G1 BL S-Mount

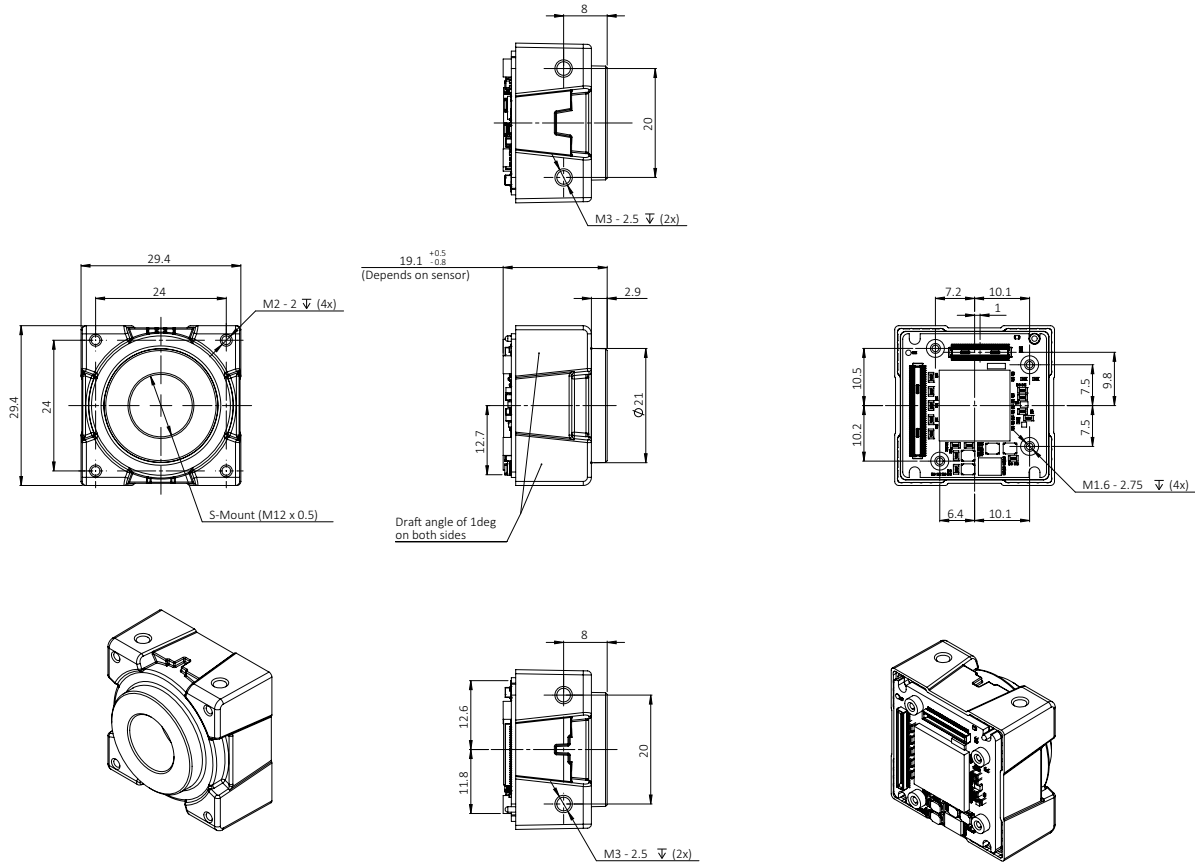

Figure 47: Alvium G1 BL S-Mount dimensions

Alvium G1 BL Frame

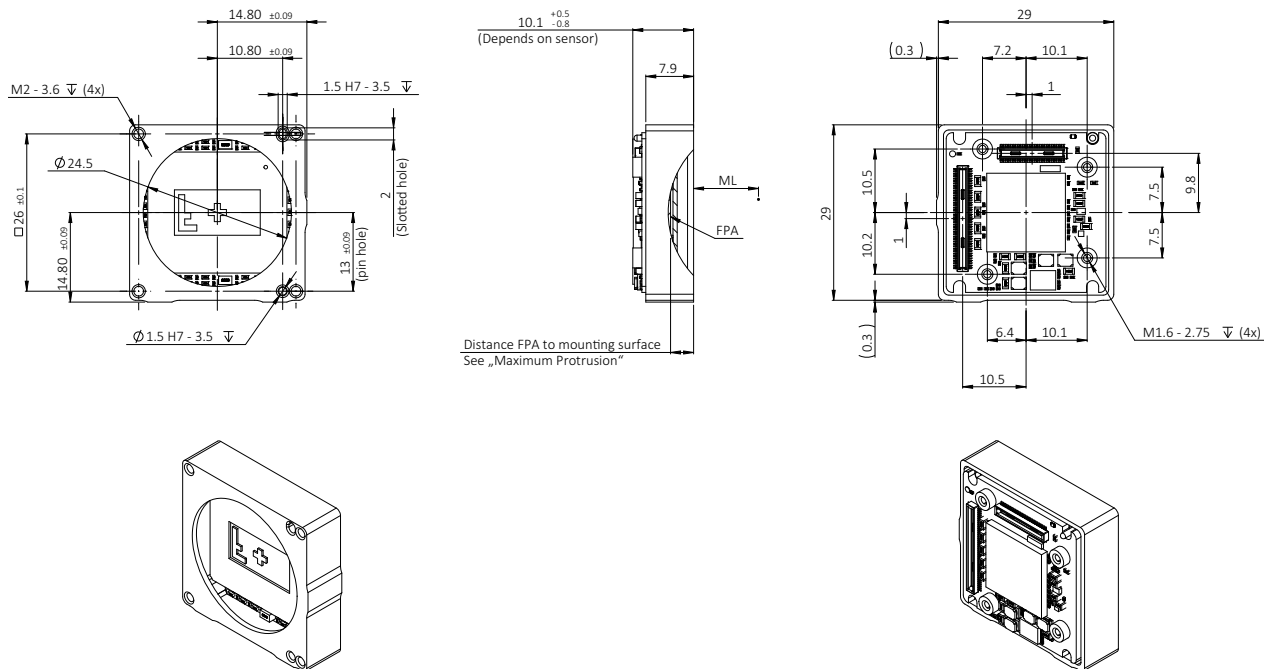

Figure 48: Alvium G1 BL Frame dimensions

Alvium G1 BL No Mount

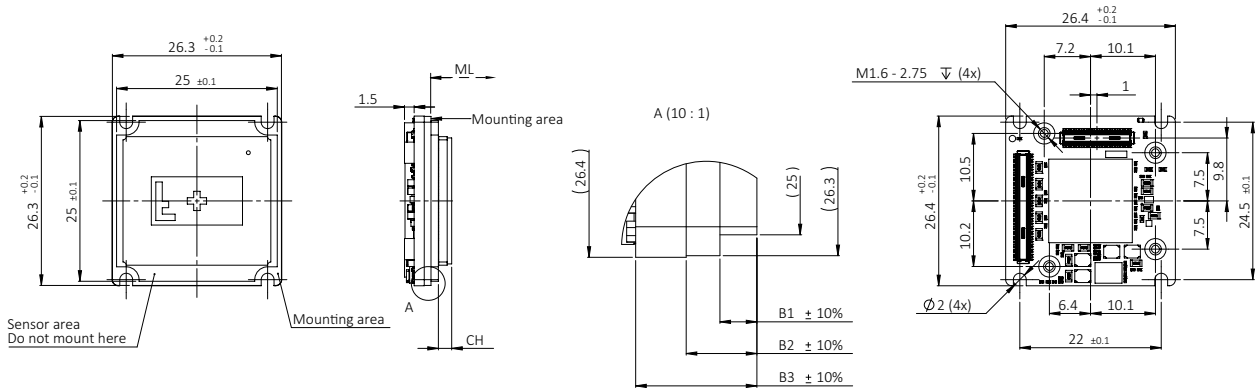

Figure 49: Alvium G1 BL No Mount dimensions

Dimensions that are common between different models are shown in [Figure 49](#), model specific dimensions are listed in [Table 74](#). **Mechanical length (ML)** defines the mechanical distance from the mounting area to the lens mount front flange, without optical filter. **Components height (CH)** relates to the electronic components with maximum height, sometimes the sensor.



Mechanical length for S-Mount and CS-Mount

Mechanical length for other mounts is:

- CS-Mount: [C-Mount value] – 5 mm
- S-Mount: depending on your design.

Camera model	ML: Mechanical length* for C-Mount	CH: Components height, incl. the sensor	B1: Board thickness	B2: Board thickness	B3: Board thickness
Alvium G1-030 VSWIR BL	19.613 mm	2.87 mm	1.25 mm	2.20 mm	3.75 mm
Alvium G1-040m/c BL	19.879 mm	2.27 mm	1.20 mm	2.20 mm	3.75 mm
Alvium G1-130 VSWIR BL	19.613 mm	2.87 mm	1.25 mm	2.20 mm	3.75 mm
Alvium G1-131m/c BL	19.845 mm	2.59 mm	1.00 mm	2.00 mm	3.55 mm
Alvium G1-158m/c BL	19.879 mm	2.27 mm	1.20 mm	2.20 mm	3.75 mm
Alvium G1-192m/c BL	19.845 mm	2.59 mm	1.00 mm	2.00 mm	3.55 mm
Alvium G1-234m/c BL	19.713 mm	2.87 mm	1.10 mm	2.20 mm	3.75 mm
Alvium G1-240m/c BL	19.929 mm	2.27 mm	1.25 mm	2.20 mm	3.75 mm
Alvium G1-319m/c BL	19.929 mm	2.27 mm	1.25 mm	2.20 mm	3.75 mm
Alvium G1-500m/c BL	19.739 mm	1.67 mm	1.30 mm	2.40 mm	3.95 mm

*Theoretical values

Table 74: Alvium G1 BL No Mount model specific dimensions and nominal values (sheet 1 of 2)

Camera model	ML: Mechanical length* for C-Mount	CH: Components height, incl. the sensor	B1: Board thickness	B2: Board thickness	B3: Board thickness
Alvium G1-507m/c BL	19.929 mm	2.27 mm	1.25 mm	2.20 mm	3.75 mm
Alvium G1-507m/c BL Pol	19.929 mm	2.27 mm	1.25 mm	2.20 mm	3.75 mm
Alvium G1-510m/c BL	19.713 mm	2.20 mm	1.10 mm	2.20 mm	3.75 mm
Alvium G1-811m/c BL	19.613 mm	2.88 mm	1.00 mm	2.20 mm	3.75 mm
Alvium G1-812 UV BL	19.610 mm	2.88 mm	1.00 mm	2.20 mm	3.75 mm
Alvium G1-895m/c BL	19.829 mm	2.27 mm	1.15 mm	2.20 mm	3.75 mm
Alvium G1-1236m/c BL	19.829 mm	2.27 mm	1.15 mm	2.20 mm	3.75 mm
Alvium G1-1240m/c BL	19.763 mm	2.20 mm	1.15 mm	2.20 mm	3.75 mm
Alvium G1-1242m/c BL	19.613 mm	2.88 mm	1.00 mm	2.20 mm	3.75 mm
Alvium G1-1620m/c BL	19.613 mm	2.88 mm	1.00 mm	2.20 mm	3.75 mm
Alvium G1-2040m/c BL	19.613 mm	2.88 mm	1.00 mm	2.20 mm	3.75 mm
Alvium G1-2050m/c BL	19.663 mm	2.87 mm	1.05 mm	2.20 mm	3.75 mm
Alvium G1-2460m/c BL	19.613 mm	2.88 mm	1.00 mm	2.20 mm	3.75 mm
*Theoretical values					

Table 74: Alvium G1 BL No Mount model specific dimensions and nominal values (sheet 2 of 2)

Alvium G1 BL interface unit

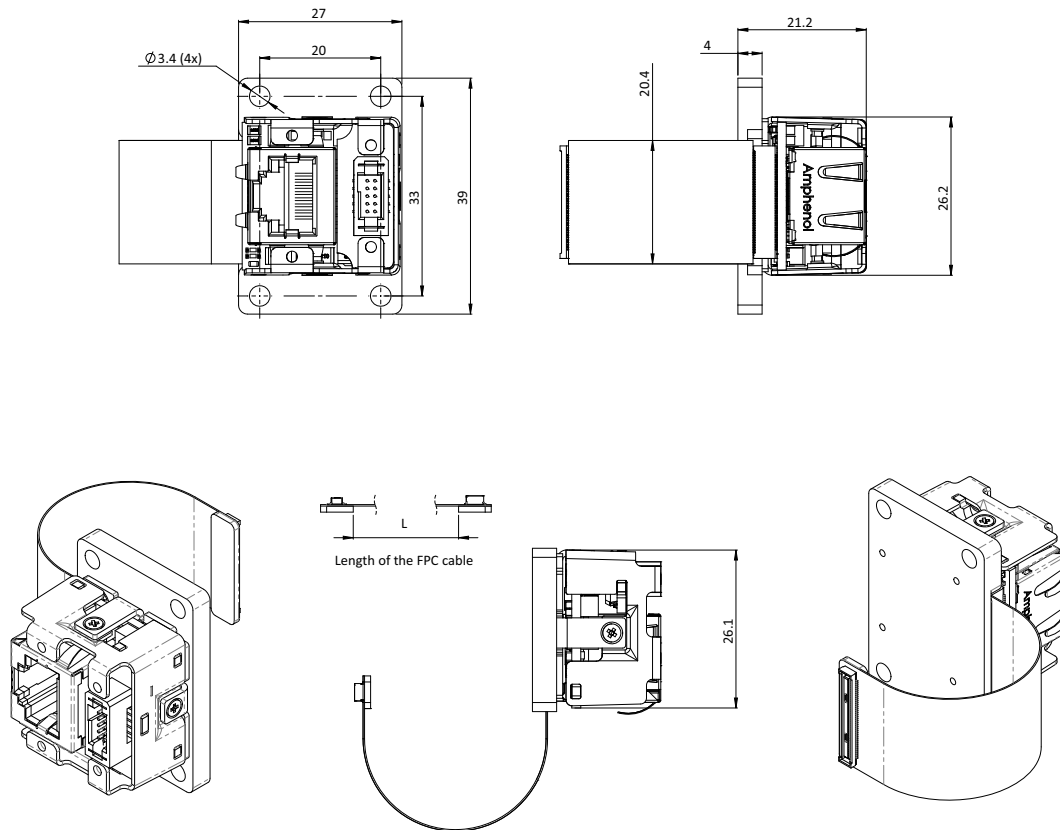

Figure 50: Alvium G1 BL interface unit dimensions



FPC cable length

Dimension L in [Figure 50](#) above:

Alvium G1 BL cameras are available with 110 mm and 200 mm FPC cables.

Lens mounts and maximum protrusion.



No need to readjust lens mounts

Alvium G1 camera mounts are adjusted with high precision during manufacturing. Construction ensures permanent accuracy without need to readjust.

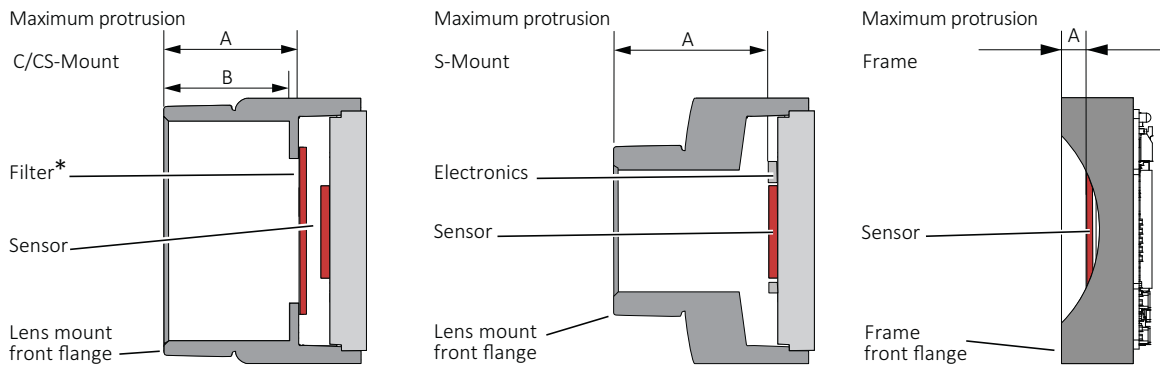

*Only color models are equipped with an IR cut filter

Figure 51: Maximum protrusion CS-Mount and C-Mount, S-Mount, Frame

Figure 51 shows schematics for maximum protrusion of lenses, [Table 75](#) shows values for maximum protrusion.



NOTICE

Damage to sensor or optics by unsuitable lenses

The sensor, filter, or lens can be damaged if a lens exceeding maximum protrusion is mounted to the camera.

- Use lenses with less than the allowed maximum protrusion, see [Table 75](#).
- See [Mounting the lens](#) on page 204.
- For S-Mount lenses, see [Mounting and focusing S-Mount lenses](#) on page 205.

Mount	Maximum protrusion
C-Mount	13.6 mm
CS-Mount	8.6 mm
S-Mount	11.0 mm
Frame	1.5 mm

Table 75: Maximum protrusion for Alvium G1 cameras

IR cut filter

The following table shows which Alvium G1 models are equipped with an IR cut filter. The filter is permanently installed and cannot be removed.

Color or monochrome model	C-Mount	CS-Mount	S-Mount	No Mount	Frame
Color	Type Hoya C-5000 IR cut filter		No filter		
Monochrome and VSWIR	No filter				

Table 76: Optical filter availability

Cameras **without** IR cut filter have a higher sensitivity for low-light imaging. Moreover, spectral sensitivity is increased.

Cameras **with** IR cut filter are more accurate in reproduction of color, contrast, and sharpness, as the filter absorbs near-IR wavelengths. See [Figure 52](#) for filter transmission.



Spectral transmission values

The following curve shows typical transmission for type Hoya C5000 IR cut filter. Values may vary slightly by filter lot.

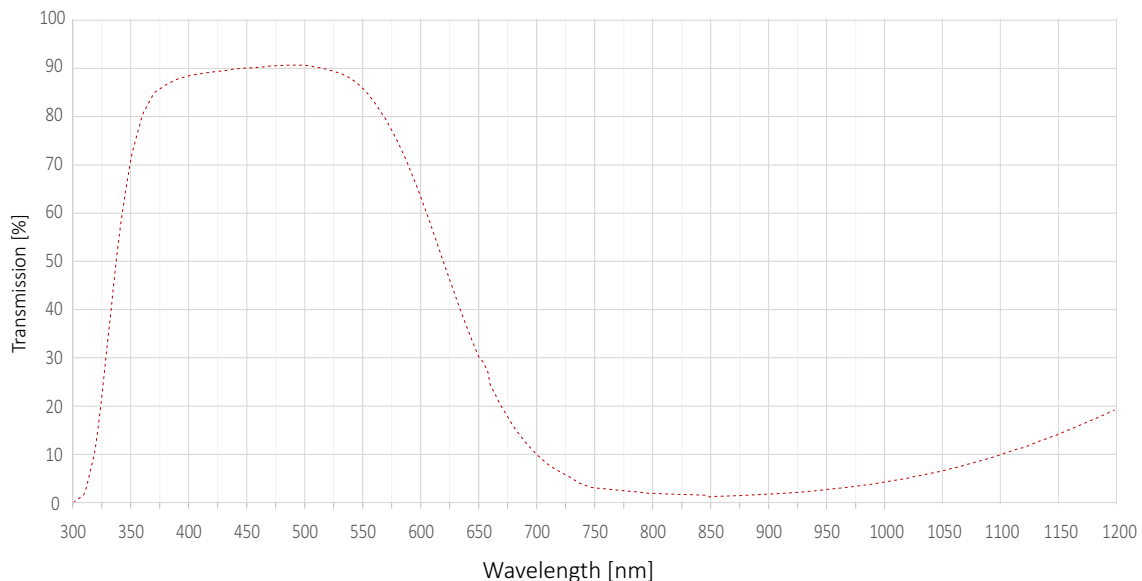

Figure 52: Spectral transmission for type Hoya C5000 IR cut filter (exemplary curve)



S-Mount lenses with IR cut design

For improved image quality, we recommend using S-Mount lenses that are IR- optimized or that have IR cut coating. See the S-Mount Lenses User Guide at www.alliedvision.com/fileadmin/content/documents/products/accessories/lenses/Allied_Vision/User_Guide/S-Mount-Lenses_User-Guide.pdf.

Sensor position accuracy



Sensor alignment for Alvium G1 BL No Mount cameras

The sensors in Alvium G1 BL No Mount cameras are not aligned to a lens mount. You must align these cameras into housings individually, which can be difficult and expensive. As a possible solution, Alvium Frame cameras provide alignment areas and holes to fit into individual housings, see [Alvium G1 BL Frame - use your own optical mount](#) on page 18.

Housed Alvium G1 cameras: Sensor shift and rotation

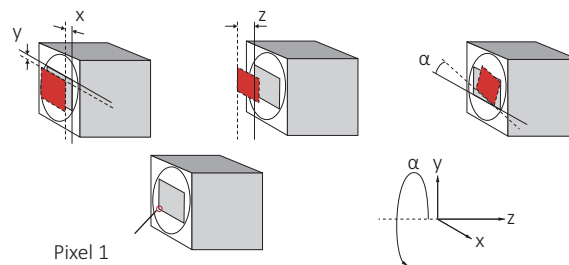

Gray rectangle: Reference sensor position **Red rectangle:** Current position
Straight line: Reference edge **Dotted line:** Current reference edge

The orientation of the z-axis deviates from scientific conventions to define tolerances of the flange focal distance.

Figure 53: Sensor shift and rotation

The following table defines the manufacturing accuracy for sensor positioning of housed Alvium G1 cameras.

Criteria	Subject	Properties
Alignment method		Optical alignment of the photosensitive sensor area into the camera front module (lens mount front flange)
Reference Points	Sensor	Center of the pixel area (photo sensitive cells)
	Camera	Center of the lens mount
Accuracy	x/y-axis ¹	±150 µm (sensor shift)
	z	0 to -100 µm (optical back focal length)
	α ¹	±0.5 deg (sensor rotation as the deviation from the parallel to the camera bottom)

¹ We cannot measure or guarantee these values for S-Mount hardware options that are manufactured on customer request for: Alvium G1-234, -507, -507 Pol, -811, -812 UV, -895, -1236, -1242, -1620, -2040, -2050, and -2460.

Table 77: Alvium G1 cameras, criteria of sensor position accuracy

Values for Alvium G1 BL Frame cameras

For sensor shift and rotation with Alvium G1 BL Frame cameras, see [Housed Alvium G1 BL Frame: Sensor shift and rotation](#) on page 170. For sensor tilt, see [All housed Alvium G1 cameras: Sensor tilt](#) on page 170.

Housed Alvium G1 BL Frame: Sensor shift and rotation

The following table defines the manufacturing accuracy for sensor positioning with housed Alvium G1 BL Frame cameras. For sensor tilt, see [All housed Alvium G1 cameras: Sensor tilt](#) on page 170.

Criteria	Subject	Properties
Alignment method		Optical alignment of the photosensitive sensor area into the camera front module (lens mount front flange)
Reference Points	Sensor	Center of the pixel area (photo sensitive cells)
	Camera	Center of the Frame lens mount
Accuracy	x/y-axis	$\pm 90 \mu\text{m}$ (sensor shift)
	z	0 to $-50 \mu\text{m}$ (optical back focal length)
	α^1	$\pm 0.5 \text{ deg}$ (sensor rotation as the deviation from the parallel to the camera bottom)

Table 78: Alvium CSI-2 Frame cameras, sensor shift and rotation

All housed Alvium G1 cameras: Sensor tilt

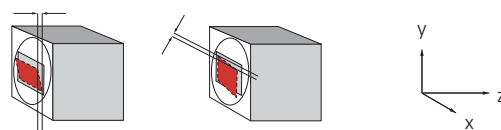

Gray rectangle: Reference sensor position **Red rectangle:** Current position

Figure 54: Sensor tilt

The following table defines sensor tilt as the variance between highest and lowest pixel of a sensor along the z-axis, measured in micrometers for housed Alvium G1 cameras.

Alvium G1 model	Pixel size	Maximum tilt
Alvium G1-030 VSWIR	$5 \mu\text{m} \times 5 \mu\text{m}$	$50 \mu\text{m}$
Alvium G1-040m/c	$6.9 \mu\text{m} \times 6.9 \mu\text{m}$	$95 \mu\text{m}$

Table 79: Sensor tilt

Alvium G1-130 VSWIR	5 μm \times 5 μm	50 μm
Alvium G1-131m/c	5.3 μm \times 5.3 μm	57 μm
Alvium G1-158m/c	3.45 μm \times 3.45 μm	24 μm
Alvium G1-192m/c	4.5 μm \times 4.5 μm	41 μm
Alvium G1-234m/c	5.86 μm \times 5.86 μm	69 μm
Alvium G1-240m/c	3.45 μm \times 3.45 μm	24 μm
Alvium G1-319m/c	3.45 μm \times 3.45 μm	24 μm
Alvium G1-500m/c	2.2 μm \times 2.2 μm	15 μm
Alvium G1-507m/c	3.45 μm \times 3.45 μm	24 μm
Alvium G1-507m/c Pol	3.45 μm \times 3.45 μm	24 μm
Alvium G1-510m/c	2.74 μm \times 2.74 μm	18 μm
Alvium G1-811m/c	2.74 μm \times 2.74 μm	18 μm
Alvium G1-812 UV	2.74 μm \times 2.74 μm	15 μm
Alvium G1-895m/c	3.45 μm \times 3.45 μm	24 μm
Alvium G1-1236m/c	3.45 μm \times 3.45 μm	24 μm
Alvium G1-1240m/c	1.85 μm \times 1.85 μm	12 μm
Alvium G1-1242m/c	2.74 μm \times 2.74 μm	18 μm
Alvium G1-1620m/c	2.74 μm \times 2.74 μm	18 μm
Alvium G1-2040m/c	2.74 μm \times 2.74 μm	18 μm
Alvium G1-2050m/c	2.4 μm \times 2.4 μm	12 μm
Alvium G1-2460m/c	2.74 μm \times 2.74 μm	18 μm

Table 79: Sensor tilt

User sets

Supported features

UserSet features enable to store individual settings on Alvium G1 cameras. These user sets can be loaded by default, without needing to set values by software after every restart of the camera. Or they can be used to switch between different settings, for example, to adjust from daylight to artificial light.

User sets on Alvium G1 cameras support all features except for:

- Selectors
- Command features
- Read-only features
- Features in the LUTControl1 category.

Trigger features and UserSetDefault

Trigger features are reset to default values when the default user set is loaded.

- Column **UserSetLoad** displays how user values are affected when the command for **UserSetLoad** is executed.
- Column **DeviceReset** displays how user values are affected when the command for **DeviceReset** is executed.

Feature	Default value	UserSetDefault	DeviceReset
TriggerActivation	<i>RisingEdge</i>	Default value	Default value
TriggerMode	<i>Off</i>	Default value	Default value
TriggerSelector	<i>AcquisitionStart</i>	User value	Default value
TriggerSoftware	[Command]	Not applicable	Not applicable
TriggerSource	<i>Software</i>	Default value	Default value

Table 80: Trigger features being reset

Camera feature availability

Alvium G1 cameras support a number of standard and extended features. The following tables compare the availability of selected features by model.



Feature descriptions and firmware downloads

Alvium Features Reference: www.alliedvision.com/en/support/technical-documentation/alvium-gige-documentation

Firmware downloads: www.alliedvision.com/en/support/firmware-downloads.

Image control	Monochrome models	Color models	Supported models
Adaptive noise correction	✓	✓	All, except for: G1-507 Pol
Auto exposure	✓	✓	All
Auto gain	✓	✓	All
Auto white balance	-	✓	All, except for: G1-507 Pol
Color transformation (including hue, saturation)	-	✓	
Contrast	✓	✓	
Custom convolution	✓	✓	
De-Bayering up to 5x5	-	✓	

Table 81: Image control features by Alvium G1 model (sheet 1 of 2)

Image control	Monochrome models	Color models	Supported models
Digital binning	✓	✓	All, except for: G1-507 Pol
DPC (defect pixel correction)	✓	✓	
FPNC (fixed pattern noise correction)	✓	✓	All, except for: G1-030 VSWIR, -130 VSWIR, -234, -507 Pol, -895, -2050
Gamma	✓	✓	All
Lens shading correction	✓	✓	All
Look up table (LUT)	✓	✓	All, except for: G1-507 Pol
Multiple ROI (regions of interest)	✓	✓	All, except for: G1-131, -192, -500, -1240, -2050
Reverse X/Y	✓	✓	All
Sensor binning	✓	-	G1-158m, -240m, -500, -510m, -811m, -812 UV, -1242m, -1620m, -2040m, -2460m
Sharpness/Blur	✓	✓	All, except for: G1-507 Pol
Single ROI (region of interest)	✓	✓	All

Table 81: Image control features by Alvium G1 model (continued) (sheet 2 of 2)

Camera control	Monochrome models	Color models	Supported models
Acquisition frame rate	✓	✓	All
Action commands	✓	✓	All
Bandwidth control (DeviceLinkThroughputLimit)	✓	✓	All
Burst mode (TransferControl features)	✓	✓	All
Counters and timers	✓	✓	All
Events	✓	✓	All
Firmware update in the field	✓	✓	All
Image chunk data	✓	✓	All
I/O and trigger control	✓	✓	All

Table 82: Camera control features by Alvium G1 model (sheet 1 of 2)

Camera control	Monochrome models	Color models	Supported models
Readout modes (SensorBitDepth)	✓	✓	G1-030 VSWIR, -040, -130 VSWIR, -158, -234, -240
Sequencer	✓	✓	All, except for: G1 -500, -1240, -2050
Serial I/Os	✓	✓	All
Temperature monitoring (mainboard, companion board, interface board)	✓	✓	All
User sets	✓	✓	All

Table 82: Camera control features by Alvium G1 model (sheet 2 of 2)

Lenses: Focal length vs. field of view

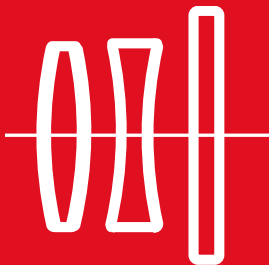

This chapter includes:

About this chapter	176
Optical vignetting with certain lenses	176
About S-Mount lenses	177
Focal length versus field of view	177

About this chapter

This section presents tables that list selected fields of view (FOV) depending on sensor size, distance, and focal length of the lens.

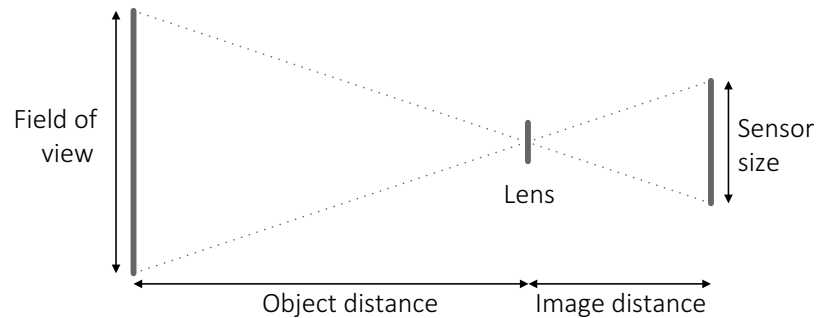

Figure 55: Parameters used in tables for focal length versus FOV



Allied Vision S-Mount lenses

For technical data of Allied Vision S-Mount lenses with dedicated operating instructions, see the S-Mount Lenses User Guide at

www.alliedvision.com/fileadmin/content/documents/products/accessories/lenses/Allied_Vision/User_Guide/S-Mount-Lenses_User-Guide.pdf.

Parameters in tables

The distance to the object is measured from the first principal the plane of the lens to the object. For some lenses, manufacturers do not define the principal plane position. Production spread causes tolerances for all values, including actual focal lengths. Calculations apply for image reproduction without distortion. Therefore, values do not apply for fisheye lenses.

Please ask your Allied Vision Sales representative in case you need more information.

Optical vignetting with certain lenses

Lenses with short focal lengths may show optical vignetting at the edges of the image. Microlenses on the sensor pixels can increase the effect.

For demanding applications, we suggest testing camera and lens to find a suitable setup. If you have questions, please contact your Allied Vision Sales representative.

About S-Mount lenses

Alvium G1 S-Mount models have no filter. We recommend using S-Mount lenses with an integrated IR-cut filter for a better image quality.

Read [Mounting and focusing S-Mount lenses](#) on page 205 to avoid damage when using S-Mount lenses.

Focal length versus field of view

Alvium G1-030 VSWIR

Values for G1-030 VSWIR cameras with Type 1/4 (4.1 mm diagonal) sensors:

Focal length [mm]	Field of view (H × V [mm])	
	Object distance = 500 mm	Object distance = 1000 mm
4	407 × 322	817 × 647
5	775 × 773	1557 × 1553
6	644 × 642	1296 × 1293
8	481 × 480	970 × 968
12	318 × 317	644 × 642
16	237 × 236	481 × 480
25	149 × 148	305 × 304
35	104 × 104	216 × 215
50	70 × 70	149 × 148

Table 83: Focal length versus field of view for Alvium G1-030 VSWIR

Alvium G1-040m/c

Values for G1-040m/c cameras with Type 1/2.9 (6.3 mm diagonal) sensors:

Focal length [mm]	Field of view (H × V [mm])	
	Object distance = 500 mm	Object distance = 1000 mm
2.8	892 × 667	1789 × 1337
3.6	693 × 518	1390 × 1039
4.8	518 × 387	1041 × 778
6	414 × 309	832 × 622
8	309 × 231	623 × 465
12	204 × 153	414 × 309
16	152 × 114	309 × 231
25	95 × 71	196 × 146

Table 84: Focal length versus field of view for Alvium G1-040m/c

Alvium G1-130 VSWIR

Values for G1-130 VSWIR cameras with Type 1/2 (8.2 mm diagonal) sensors:

Focal length [mm]	Field of view (H × V [mm])	
	Object distance = 500 mm	Object distance = 1000 mm
5	671 × 560	1348 × 1125
6	558 × 466	1122 × 937
8	417 × 348	840 × 701
12	275 × 230	558 × 466
16	205 × 171	417 × 348
25	129 × 107	264 × 221
35	90 × 75	187 × 156
50	61 × 51	129 × 107

Table 85: Focal length versus field of view for Alvium G1-130 VSWIR

Alvium G1-131m/c

Values for G1-131m/c cameras with Type 1/1.8 (8.7 mm diagonal) sensors:

Focal length [mm]	Field of view (H × V in [mm])	
	Object distance = 500 mm	Object distance = 1000 mm
4.8	700 × 560	1407 × 1125
6	559 × 447	1124 × 899
8	417 × 334	841 × 673
12	276 × 221	559 × 447
16	205 × 164	417 × 334
25	129 × 103	265 × 212
35	90 × 72	187 × 150
50	61 × 49	129 × 103

Table 86: Focal length versus field of view for Alvium G1-131m/c

Alvium G1-158m/c

Values for G1-158m/c cameras with Type 1/2.9 (6.3 mm diagonal) sensors:

Focal length [mm]	Field of view (H × V [mm])	
	Object distance = 500 mm	Object distance = 1000 mm
2.8	892 × 667	1789 × 1337
3.6	693 × 518	1390 × 1039
4.8	518 × 387	1041 × 778
6	414 × 309	832 × 622
8	309 × 231	623 × 465
12	204 × 153	414 × 309
16	152 × 114	309 × 231
25	95 × 71	196 × 146

Table 87: Focal length versus field of view for Alvium G1-158m/c

Alvium G1-192m/c

Values for G1-192m/c cameras with Type 1/1.8 (9.0 mm diagonal) sensors:

Focal length [mm]	Field of view (H × V in [mm])	
	Object distance = 500 mm	Object distance = 1000 mm
4.8	743 × 557	1493 × 1120
6	593 × 445	1193 × 895
8	443 × 332	893 × 670
12	293 × 220	593 × 445
16	218 × 163	443 × 332
25	137 × 103	281 × 211
35	96 × 72	199 × 149
50	65 × 49	137 × 103

Table 88: Focal length versus field of view for Alvium G1-192m/c

Alvium G1-234m/c

Values for G1-234m/c cameras with Type 1/1.2 (13.4 mm diagonal) sensors:

Focal length [mm]	Field of view (H × V in [mm])	
	Object distance = 500 mm	Object distance = 1000 mm
12 mm	461 × 290 mm	933 × 586 mm
16 mm	343 × 215 mm	697 × 438 mm
25 mm	215 × 135 mm	442 × 278 mm
35 mm	150 × 94 mm	312 × 196 mm
50 mm	102 × 64 mm	215 × 135 mm

Table 89: Focal length versus field of view for Alvium G1-234m/c

Alvium G1-240m/c

Values for G1-240m/c cameras with Type 1/2.3 (7.9 mm diagonal) sensors:

Focal length [mm]	Field of view (H × V in [mm])	
	Object distance = 500 mm	Object distance = 1000 mm
4.8	691 × 433	1389 × 871
6	552 × 346	1110 × 696
8	412 × 258	831 × 521
12	272 × 171	552 × 346
16	203 × 127	412 × 258
25	127 × 80	261 × 164
35	89 × 56	185 × 116
50	60 × 38	127 × 80

Table 90: Focal length versus field of view for Alvium G1-240m/c

Alvium G1-319m/c

Values for G1-319m/c cameras with Type 1/1.8 (8.9 mm diagonal) sensors:

Focal length [mm]	Field of view (H × V in [mm])	
	Object distance = 500 mm	Object distance = 1000 mm
4.8	735 × 550	1476 × 1104
6	586 × 439	1180 × 882
8	438 × 328	883 × 661
12	290 × 217	586 × 439
16	215 × 161	438 × 328
25	135 × 101	278 × 208
35	95 × 71	196 × 147
50	64 × 48	135 × 101

Table 91: Focal length versus field of view for Alvium G1-319m/c

Alvium G1-500m/c

Values for G1-500m/c cameras with Type 1/2.5 (7.1 mm diagonal) sensors:

Focal length [mm]	Field of view (H × V in [mm])	
	Object distance = 500 mm	Object distance = 1000 mm
2.8	1013 × 759	2031 × 1523
3.6	786 × 590	1578 × 1184
4.8	588 × 441	1182 × 887
6	469 × 352	945 × 709
8	351 × 263	707 × 530
12	232 × 174	469 × 352
16	172 × 129	351 × 263
25	108 × 81	222 × 167

Table 92: Focal length versus field of view for Alvium G1-500m/c

Alvium G1-507m/c, -507 m/c Pol

Values for G1-507m/c and -507m/c Pol cameras Type 2/3 (11.1 mm diagonal) sensors:

Focal length [mm]	Field of view (H × V in [mm])	
	Object distance = 500 mm	Object distance = 1000 mm
6	700 × 584	1408 × 1175
8	523 × 436	1054 × 880
12	346 × 288	700 × 584
16	257 × 215	523 × 436
25	162 × 135	332 × 277
35	113 × 94	234 × 196
50	77 × 64	162 × 135

Table 93: Focal length versus field of view for Alvium G1-507m/c, -507m/c Pol

Alvium G1-510m/c

Values for G1-510m/c cameras with Type 1/1.8 (8.8 mm diagonal) sensors:

Focal length [mm]	Field of view (H × V in [mm])	
	Object distance = 500 mm	Object distance = 1000 mm
5	671 × 560	1348 × 1125
6	558 × 466	1122 × 937
8	417 × 348	840 × 701
12	275 × 230	558 × 466
16	205 × 171	417 × 348
25	129 × 107	264 × 221
35	90 × 75	187 × 156
50	61 × 51	129 × 107

Table 94: Focal length versus field of view for Alvium G1-510m/c

Alvium G1-811m/c, -812 UV

Values for G1-811m/c and -812 UV cameras Type 2/3 (11.0 mm diagonal) sensors:

Focal length [mm]	Field of view (H × V in [mm])	
	Object distance = 500 mm	Object distance = 1000 mm
5	773 × 773	1553 × 1553
6	642 × 642	1293 × 1293
8	480 × 480	968 × 968
12	317 × 317	642 × 642
16	236 × 236	480 × 480
25	148 × 148	304 × 304
35	104 × 104	215 × 215
50	70 × 70	148 × 148

Table 95: Focal length versus field of view for Alvium G1-811m/c, -812 UV

Alvium G1-895m/c

Values for G1-895m/c cameras with Type 1 (16.0 mm diagonal) sensors:

Focal length [mm]	Field of view (H × V in [mm])	
	Object distance = 500 mm	Object distance = 1000 mm
12	577 × 305	1168 × 618
16	429 × 227	873 × 462
25	270 × 143	553 × 293
35	189 × 100	391 × 286
50	128 × 68	270 × 143
100	57 × 30	128 × 68
135	38 × 20	91 × 48

Table 96: Focal length versus field of view for Alvium G1-895m/c

Alvium G1-1236m/c

Values for G1-1236m/c cameras with Type 1.1 (17.6 mm diagonal) sensors:

Focal length [mm]	Field of view (H × V in [mm])	
	Object distance = 500 mm	Object distance = 1000 mm
8	872 × 638	1759 × 1287
12	577 × 422	1168 × 854
16	429 × 314	872 × 638
25	270 × 197	553 × 405
35	188 × 138	391 × 286
50	128 × 93	270 × 197
75	80 × 59	175 × 128

Table 97: Focal length versus field of view for Alvium G1-1236m/c

Alvium G1-1240m/c

Values for G1-1240m/c cameras with Type 1/1.7 (9.3 mm diagonal) sensors:

Focal length [mm]	Field of view (H × V in [mm])	
	Object distance = 500 mm	Object distance = 1000 mm
4.8	763 × 578	1534 × 1161
6	609 × 461	1226 × 928
8	455 × 344	918 × 694
12	301 × 228	609 × 461
16	224 × 169	455 × 344
25	141 × 106	289 × 218
35	98 × 74	204 × 154
50	67 × 50	141 × 106

Table 98: Focal length versus field of view for Alvium G1-1240m/c

Alvium G1-1242m/c

Values for G1-1242m/c cameras with Type 1/1.1 (14.0 mm diagonal) sensors:

Focal length [mm]	Field of view (H × V in [mm])	
	Object distance = 500 mm	Object distance = 1000 mm
6	931 × 679	1874 × 1365
8	696 × 507	1403 × 1022
12	460 × 335	931 × 679
16	342 × 249	696 × 507
25	215 × 157	441 × 321
35	150 × 109	312 × 227
50	102 × 74	215 × 157
75	64 × 47	139 × 102

Table 99: Focal length versus field of view for Alvium G1-1242m/c

Alvium G1-1620m/c

Values for G1-1620m/c cameras with Type 1.1 (16.8mm diagonal) sensors:

Focal length [mm]	Field of view (H × V in [mm])	
	Object distance = 500 mm	Object distance = 1000 mm
5	1445 × 825	2905 × 1658
6	1202 × 686	2419 × 1380
8	898 × 512	1810 × 1033
12	594 × 339	1202 × 686
16	442 × 252	898 × 512
25	277 × 158	569 × 325
35	194 × 111	403 × 230
50	131 × 75	277 × 158
75	83 × 47	180 × 103

Table 100: Focal length versus field of view for Alvium G1-1620m/c

Alvium G1-2040m/c

Values for G1-2040m/c cameras with Type 1.1 (17.5 mm diagonal) sensors:

Focal length [mm]	Field of view (H × V in [mm])	
	Object distance = 500 mm	Object distance = 1000 mm
6	1018 × 1018	2048 × 2048
8	760 × 760	1533 × 1533
12	503 × 503	1018 × 1018
16	374 × 374	760 × 760
25	235 × 235	482 × 482
35	164 × 164	341 × 341
50	111 × 111	235 × 235
75	70 × 70	152 × 152
85	60 × 60	133 × 133

Table 101: Focal length versus field of view for Alvium G1-2040m/c

Alvium G1-2050m/c

Values for G1-2050m/c cameras with Type 1 (15.9 mm diagonal) sensors:

Focal length [mm]	Field of view (H × V in [mm])	
	Object distance = 500 mm	Object distance = 1000 mm
8	811 × 542	1636 × 1093
12	536 × 358	1086 × 726
16	399 × 267	811 × 542
25	251 × 167	514 × 344
35	175 × 117	364 × 243
50	119 × 79	251 × 167
75	75 × 50	163 × 109
85	64 × 43	142 × 95
100	53 × 35	119 × 79

Table 102: Focal length versus field of view for Alvium G1-2050m/c

Alvium G1-2460m/c

Values for G1-2460m/c cameras with Type 1.2 (19.3 mm diagonal) sensors:

Focal length [mm]	Field of view (H × V in [mm])	
	Object distance = 500 mm	Object distance = 1000 mm
8	898 × 776	1810 × 1566
12	594 × 513	1202 × 1040
16	442 × 382	898 × 776
25	277 × 240	569 × 492
35	194 × 168	403 × 348
50	131 × 114	277 × 240
75	83 × 72	180 × 156

Table 103: Focal length versus field of view for Alvium G1-2460m/c

Installing the camera



This chapter includes:

Touching hot cameras	189
Sensor damage by ESD.....	189
Alvium G1 BL No Mount cameras.....	189
Using heat sinks	191
Mounting Alvium G1 cameras	193
Mounting the lens.....	204
Configuring the host computer	208
IP settings	209
Connecting the camera to the host.....	211
Powering up the camera.....	212
Software for your Alvium G1	213

Touching hot cameras



CAUTION

Risk of burns

A camera in operation can reach temperature levels which could cause burns.

- Wear protective gloves when you touch a camera that is heated up.
- Ensure proper cooling of the camera.

Keep the operating temperature in the specified range to enable best image quality and to protect the camera from damage. In many cases, mounting the camera on a metal surface or using a lens will be sufficient to cool the camera effectively. However, especially when operated in higher ambient temperatures, additional measures for heat dissipation, such as using a heat sink, should be considered.

Sensor damage by ESD



NOTICE

Possible damage to the sensor

In Alvium G1 BL (Board Level) cameras, sensors can be damaged by ESD. In the output image, this may become visible as bubbles or blobs, for example.

For details, see [Possible damage to image sensors due to electrostatic charge](#) on page 51.

- Provide ESD protection measures in accordance with technical standards.
- Follow the instructions in [ESD](#) on page 48.

Alvium G1 BL No Mount cameras

If you intend to design an application using Alvium G1 BL No Mount cameras, please consider:

- Alvium G1 BL No Mount cameras are not aligned. You must align these cameras into housings individually, which is extremely difficult and expensive. As a possible solution, Alvium G1 BL Frame cameras provide alignment areas and holes to fit into individual housings, see [Alvium G1 BL Frame - use your own optical mount](#) on page 18.
- Aligning the sensor to the lens is extremely difficult and expensive. Therefore, we recommend you to do evaluation with housed cameras first.
- G1 BL No Mount cameras are specialized components. We cannot give all data needed for any application in advance.
- Please let us partner with you for G1 BL No Mount camera applications to ensure a successful design.

Serial numbers of Alvium® chips of G1 BL No Mount and Frame cameras



Data in this description

The following description relates to Alvium **CSI-2 bare board**. However, the serial number is indicated the same way for Alvium **G1 BL No Mount or Frame** cameras.

Alvium CSI-2 bare board cameras and Alvium G1 BL No Mount or Frame cameras do not have enough space for a label with all the required information. Therefore, they are shipped with a 25 mm × 25 mm sandwich label on the package.

In [Figure 56](#), this label shows, for example:

- Product code: 11500 for a 1500 C-210c Bare Board camera
- Alvium® chip SN (serial number): 183603543
- Camera SN (serial number): R7QW5 as digits and 2D code.

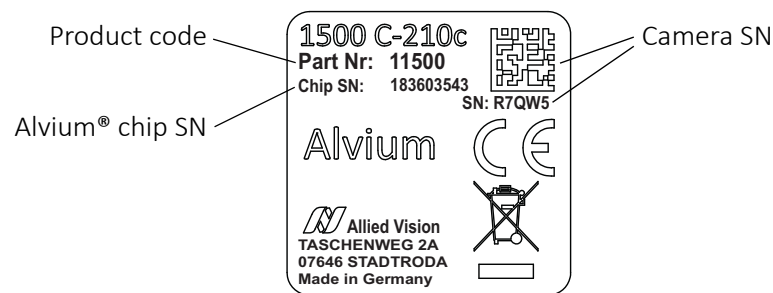

Figure 56: Sandwich label on the package of Alvium 1500 C-210c

Before operating the camera, we recommend you to pull the sandwich label off the package and stick it close to the camera.

If the label is lost, please read out with your smart phone the serial number of the Alvium® chip from the 2D code (a) shown in [Figure 57](#). With this number, we can look up the serial number of the camera in our database.

If your smart phone cannot read the 2D code: In [Figure 57](#), for example, the serial number (b) is 221406281.

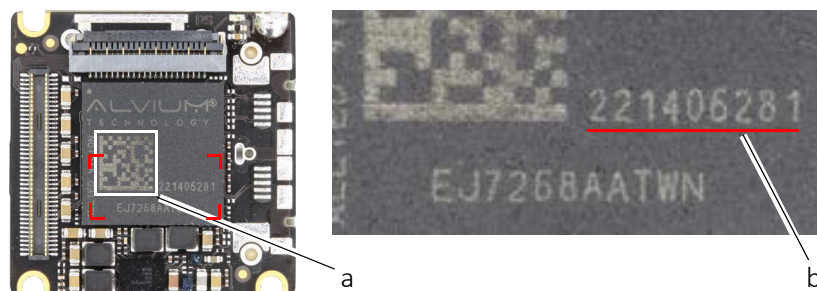

Figure 57: Alvium® chip imprint with detail view (right)

Using heat sinks

Heat dissipation for all Alvium G1 cameras

Standard Alvium G1 Closed Housing cameras can be operated without heat sinks in most applications. However, heat sinks can be used to reduce image noise and power consumption.

We recommend you to operate Alvium G1 BL cameras with heat sinks for the sensor section and additional heat dissipation for the interface section.



Automatic power off

If the mainboard temperature exceeds the specified maximum for more than two seconds, the camera is powered off automatically. Afterwards, you must power cycle the camera for restart. The current value for mainboard temperature is output by `DeviceTemperature`.



NOTICE

Damage to the camera by heat sinks mounted improperly

Adhere to the instructions and safety notes provided by the manufacturer of the heat sink.



NOTICE

Damage to the sensor, filter, and lens by corrosive substances

Some conductive media for heat sinks contain corrosive substances that can damage optical surfaces of the sensor, filter, and lens.

- Cover the optical path of the camera when you apply heat sink compound or adhesive to prevent substances and fumes from damaging optical surfaces.
- Adhere to the instructions and safety notes provided by the manufacturer of the conductive media.

Heat dissipation for Alvium G1 BL

Observe the notes above. Keep the operating temperature in the specified range to enable best image quality and to protect the camera from damage.



Optimizing heat dissipation

For details, see the Optimum Heat Dissipation for Alvium Cameras application note at www.alliedvision.com/en/support/technical-documentation/alvium-gige-documentation.



NOTICE

Damage to the camera by heat sinks mounted improperly

- Allow mechanical contact only at the cooling areas.
- Avoid any mechanical stress to the sensor and electronics area.
- Avoid short circuits of the electronics components.



NOTICE

Damage to camera electronics

Heat sinks can cause short circuits if they are not electrically isolated.

Avoid electrical contact between electronic components by unsuitable heat sinks and thermal conductive media.

Connect components in the **cooling area** (blue area in [Figure 58](#)) to a heat sink, following the instructions of the manufacturer of the heat sink and the thermal conductive media. Ensure effective cooling when you are [Mounting the G1 BL interface unit](#) on page 201.

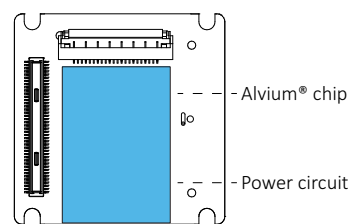

Figure 58: Cooling area for the Alvium G1 BL sensor unit



Heat sink compound

Because electronic parts vary in height, we have updated our recommendation:

- Use flexible heat sink compound to compensate for potential gaps between the electronic parts to be cooled and heat sinks.
- Consider 1 mm to cover for worst case scenarios.
- For details, see the Alvium STEP files at www.alliedvision.com/en/support/alvium-step-file-downloads.

Mounting Alvium G1 cameras



CAUTION

Injury by falling camera (parts) or lenses

A falling camera or lens can cause injury.

- Ensure proper mounting of cameras and lenses, especially for dynamic applications.
- Mount cameras as described in the instructions.
- Always make sure the mounting threads are intact.
- Fasten screws with maximum torque, using the entire thread engagement. For less thread engagement, see [Adapting maximum torque values](#) on page 203.
- We recommend you to apply thread locking.
- Use a lens support for heavy lenses.
- Use an FPC cable support for G1 BL cameras, especially for dynamic applications.

Instructions by Alvium G1 hardware option

Select the instructions corresponding to your hardware option.

Alvium G1 hardware option	Related instructions
Standard Alvium G1 Closed Housing	Mounting G1 housed cameras on page 194
Alvium G1 BL with mount (C-Mount, CS-Mount, S-Mount)	Mounting G1 housed cameras on page 194 Mounting G1 BL cameras with mount on page 196 Mounting the G1 BL interface unit on page 201
Alvium G1 BL Frame	Mounting Alvium G1 BL Frame on page 197 Mounting the G1 BL interface unit on page 201
Alvium G1 BL No Mount	Mounting G1 BL No Mount cameras on page 199 Mounting the G1 BL interface unit on page 201

Table 104: Instructions by Alvium G1 hardware option

Mounting G1 housed cameras

Top and bottom mounting

Especially for dynamic applications with high acceleration, mount the camera using the bottom mounting threads in addition.

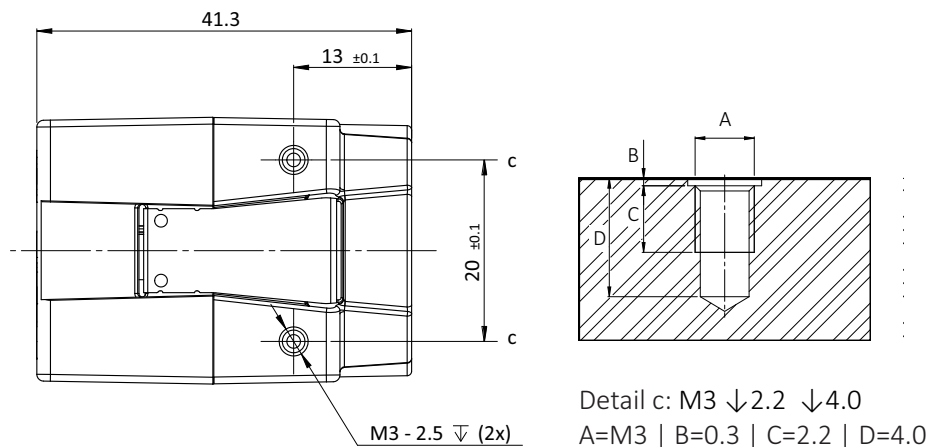

Figure 59: Mounting threads bottom and top (a)

The maximum torque value applies only if the entire thread engagement is used. For other values, see [Adapting maximum torque values](#) on page 203. For technical drawings, see [G1 Closed Housing: Dimensions and mass](#) on page 155.

1. As shown in [Figure 59](#), mount the camera to the base using suitable M3 screws for mounting thread a: At 0.51 Nm maximum torque for a thread engagement (C) of 2.2 mm between screws and mounting threads.
2. For Alvium G1 BL housed cameras, continue with [Mounting the G1 BL interface unit](#) on page 201

Front mounting

Especially for dynamic applications with high acceleration, mount the camera using the bottom mounting threads in addition.

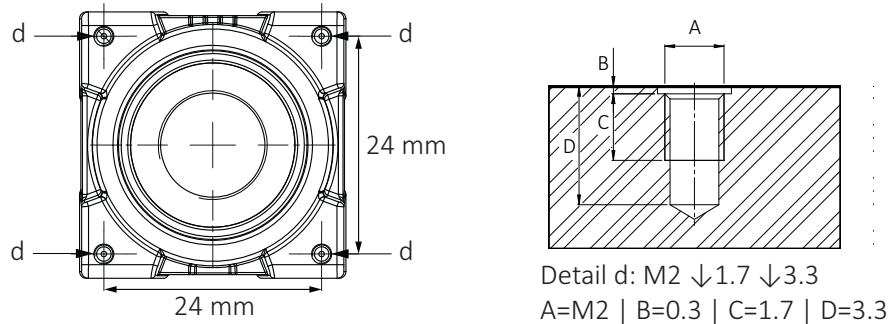

Figure 60: Camera front with mounting threads (c)

The maximum torque value applies only if the entire thread engagement is used. For other values, see [Adapting maximum torque values](#) on page 203.

1. Mount the camera to the base using suitable M2 screws at 0.17 Nm maximum torque for a thread engagement (C) of 1.7 mm between screws and mounting threads, see [Figure 60](#). For technical drawings, see [G1 Closed Housing: Dimensions and mass](#) on page 155.
 We recommend you to additionally use bottom and top mounting threads for a more solid connection.
2. For Alvim G1 BL housed cameras, continue with [Mounting the G1 BL interface unit](#) on page 201

Mounting G1 BL cameras with mount



NOTICE

Damage to the camera by short circuits

The connection between the FPC cable and the G1 BL interface unit cannot be disconnected without disassembling the interface unit. Disassembly and improper reconnection can damage the camera. **For the interface unit,...**

- **...keep the screws untouched** and keep the FPC cable connected.
- Disconnect the FPC cable **only** on the sensor unit side as shown in [Figure 61](#).

1. Disconnect the camera from power.
2. With 2 fingers grabbing the cable side FPC connector (b) at the edges, disconnect the FPC cable from the FPC connector (a) of the sensor unit as shown in [Figure 61](#).
3. Continue with [Mounting G1 housed cameras](#) on page 194.

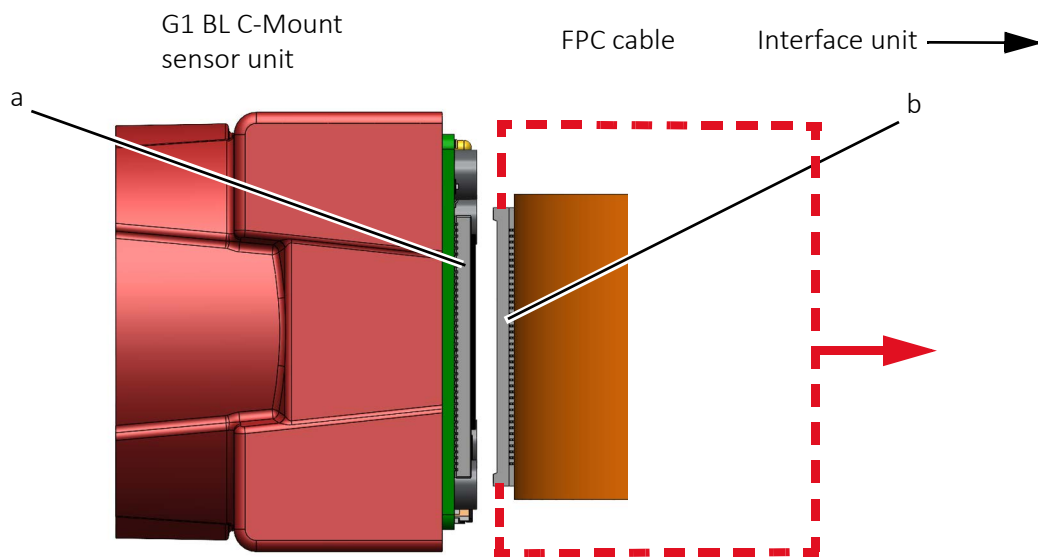

Figure 61: Disconnecting the interface unit from the sensor unit

Mounting Alvium G1 BL Frame



CAUTION

Risk of cuts by sharp edges of the circular front opening

- Avoid touching these edges with your fingers.
- Wear protective gloves for handling Alvium Frame cameras with an open circular front opening.



NOTICE

Damage to the sensor

The sensor can be damaged if its surface is exposed to dirt or mechanical stress.

- Ensure that lenses or objects, such as optical elements do not exceed the specified maximum protrusion.
- Keep your fingers and tools outside the area inside the frame flange.
- Provide the following conditions to keep dirt and droplets out of the optical system of camera:
 - Dust-free environment
 - Low relative humidity
 - No condensation.

Aligning the sensor with your optical system

Alvium Frame cameras are manufactured so that the sensor is aligned with your optical system with optimal precision. You can select between alignment methods:

A: Using the lateral alignment areas (1) and the front alignment area (2).

B: Using the front area (2) and the two alignment holes (3).

A Alignment by using the lateral alignment areas (1) and the front area (2)

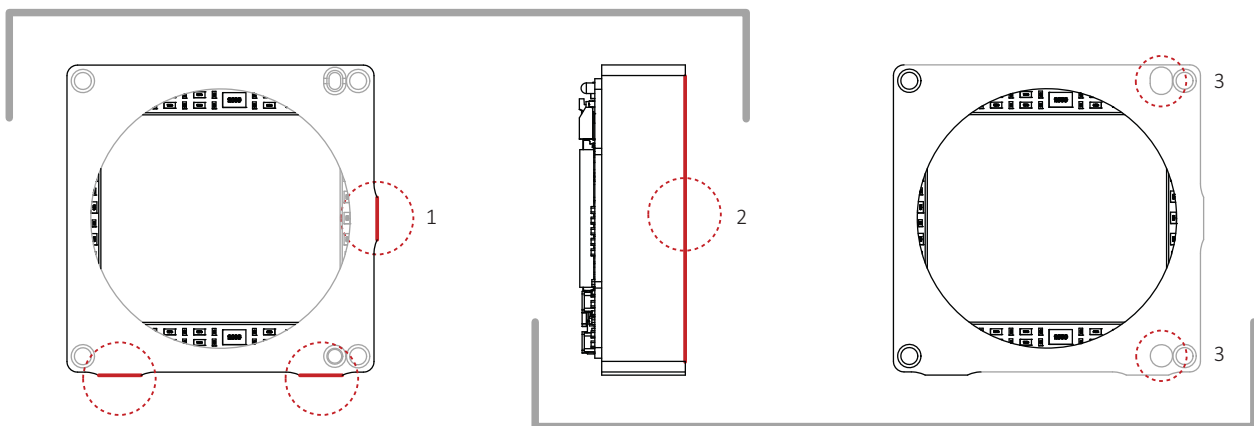

B Alignment by using the front area (2) and the alignment holes (3)

Figure 62: Alignment methods



Dimensions and accuracy

For the dimensions and accuracy of the alignment areas and the alignment holes, see the technical drawings for [Alvium G1 BL Frame](#) on page 163.

For the accuracy of the sensor position, see [Housed Alvium G1 BL Frame: Sensor shift and rotation](#) on page 170 and [All housed Alvium G1 cameras: Sensor tilt](#) on page 170.

When you design Alvium G1 BL Frame cameras into your system, observe values for:

- Flange focal distance, optical: 3.576 mm
- Maximum protrusion of 1.5 mm into the frame measured from the front area (2).

Mounting Alvium G1 BL Frame

Especially for dynamic applications with high acceleration, mount the camera using all 4 mounting threads.

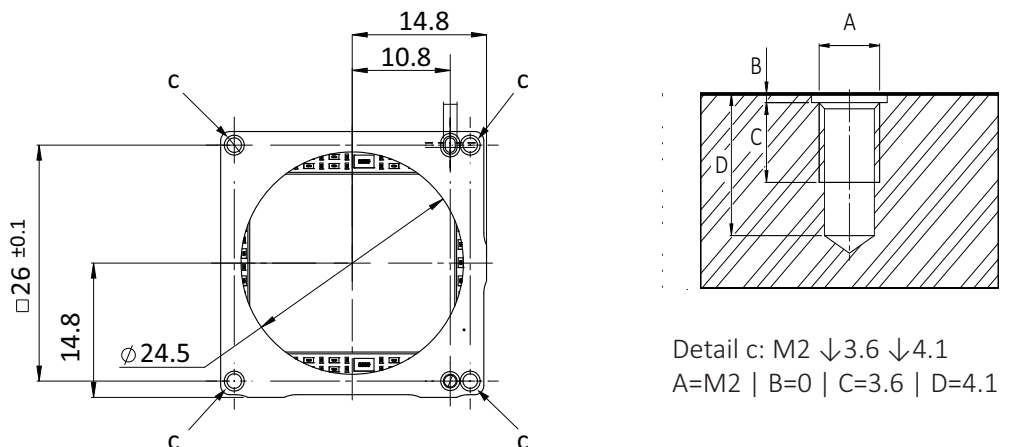

Figure 63: Mounting threads Alvium G1 BL Frame

The maximum torque value applies only if the entire thread engagement is used. For other values, see [Adapting maximum torque values](#) on page 203. For technical drawings, with further values and tolerances, and references for alignment, see the technical drawings for [Alvium G1 BL Frame](#) on page 163.

As shown in [Figure 63](#), mount the camera to the base using suitable M2 screws for the 4 mounting threads: At 0.4 Nm maximum torque for a thread engagement (C) of 3.6 mm between screws and mounting threads.

Mounting G1 BL No Mount cameras



Heat dissipation and electromagnetic compatibility for G1 BL No Mount cameras

For heat dissipation, see the Optimum Heat Dissipation for Alvium Cameras application note.

For initial guidance on electromagnetic compatibility, see the Electromagnetic Compatibility for Open Housing Alvium Cameras application note.

See www.alliedvision.com/en/support/technical-documentation/alvium-gige-documentation.



NOTICE

Damage to the camera by short circuits

The connection between the FPC cable and the G1 BL interface unit cannot be disconnected without disassembling the interface unit. Disassembly and improper reconnection can damage the camera. **For the interface unit,...**

- **...keep the screws untouched** and keep the FPC cable connected.
- Disconnect the FPC cable **only** on the sensor unit side as shown in [Figure 64](#).

1. Disconnect the camera from power.
2. With 2 fingers grabbing the cable side FPC connector (e) at the edges, disconnect the FPC cable from the FPC connector (f) of the sensor unit as shown in [Figure 64](#).

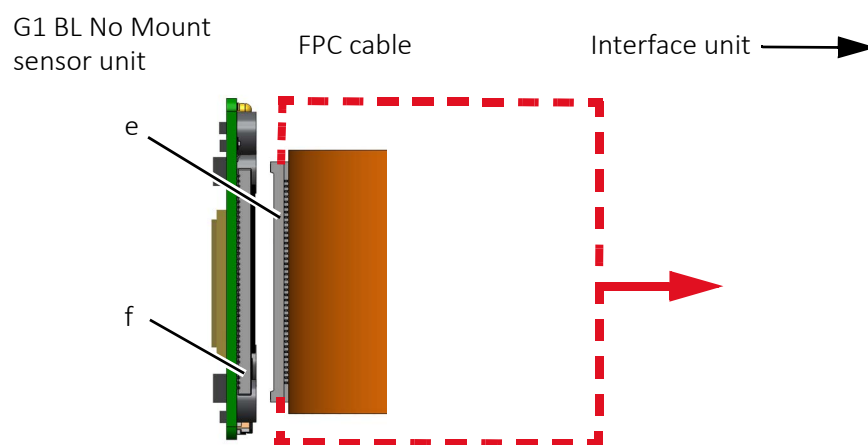

Figure 64: Disconnecting the interface unit from the sensor unit

NOTICE
Damage to the camera by improper mounting

- Allow mechanical contact only at the mounting area.
- Avoid any mechanical stress to the sensor and the electronics area.
- Avoid short circuits of the electronics components.
- Give 2 mm minimum clearance above board components.
- Tighten screws at 0.1 Nm maximum torque.

Sensor alignment for Alvium G1 BL No Mount cameras

The sensors in Alvium G1 BL No Mount cameras are not aligned to a lens mount. You must align these cameras into housings individually, which can be difficult and expensive. As a possible solution, Alvium G1 BL Frame cameras provide alignment areas and holes to fit into individual housings, see [Alvium G1 BL Frame - use your own optical mount](#) on page 18.

Schematic drawings in [Figure 65](#) show the Alvium G1 BL No Mount camera. Only the mounting area (gray) can be used for mounting. The sensor and electronics area (red) must not be touched nor put at mechanical stress.
 g = Mounting hole | h = Mounting hole and chassis ground

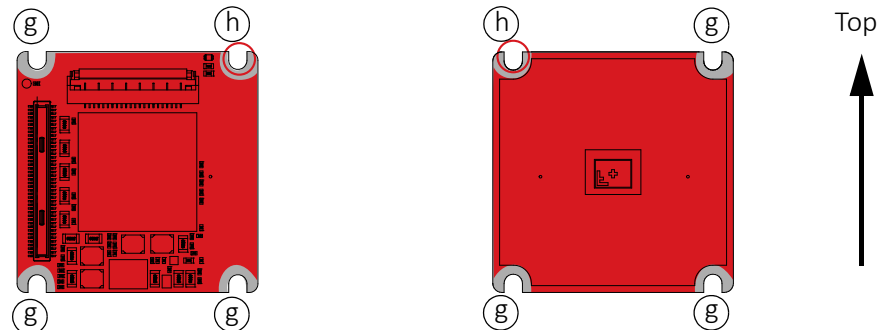

Figure 65: Mounting area of Alvium G1 BL No Mount cameras connector side (left); sensor side (right)

Mount the No Mount camera with four M1.6 screws at 0.1 Nm maximum torque.

Mounting the G1 BL interface unit



NOTICE

Damage to the camera

The interface unit does not allow disassembly by the user.

- Keep the interface unit assembled.
- Do not remove the mounting plate from the interface unit.

After mounting the Alvium G1 BL sensor unit according to [Mounting G1 BL cameras with mount](#) on page 196, [Mounting Alvium G1 BL Frame](#) on page 197, or [Mounting G1 BL No Mount cameras](#) on page 199, the interface unit must be mounted and connected as shown in this section.

1. Using 4 compatible M3 screws (i), mount the interface unit to the mounting base, as shown in [Figure 66](#) below.



Heat dissipation

Use a metal base with a large surface area and a thermal pad for the **cooling area** (blue area in [Figure 66](#)), to ensure optimum heat dissipation for the interface board.

See also [Cooling area for the Alvium G1 BL sensor unit](#) on page 192.

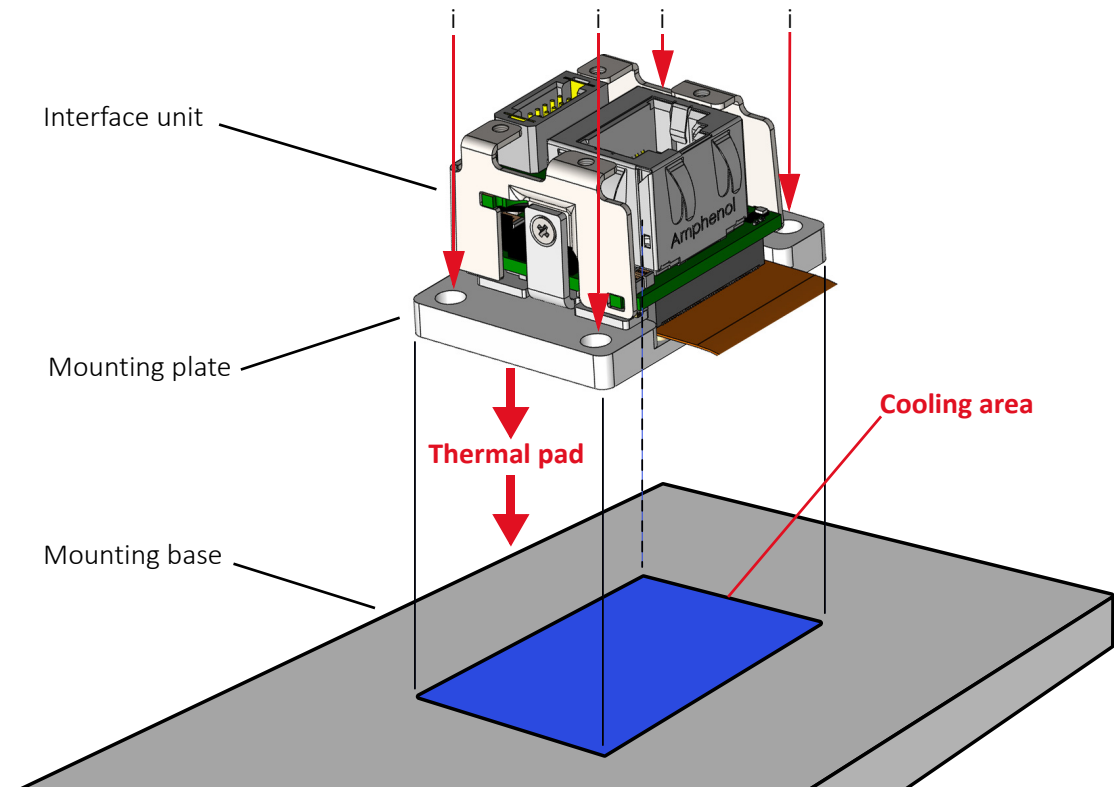

Figure 66: Mounting the G1 BL interface unit to the base

NOTICE
Damage to the camera and the connected peripherals

If the FPC cable is overstressed or if the FPC connectors are oriented incorrectly to each other, the camera and connected peripherals can be damaged.

- Connect the interface unit (l) to power only when it is properly connected to the sensor unit (k).
- Ensure the FPC connectors of the interface and sensor units are oriented to each other as shown in [Figure 67](#). **Do not rotate by 180°.**
- Ensure the FPC connectors cannot disconnect during operation.
- Avoid stress to the FPC connectors.
- Observe the maximum bending radius for FPC cables:
 - 37 mm (frequent bending)
 - 4.9 mm (moving during installation, max. 20 times bending)
 - 2.5 mm (static application, bending only one time for initial installation)

The interface unit and the sensor unit can be freely positioned as long as the warnings above are observed.

2. Align the connectors of the interface unit (l) and the sensor unit (k) to each other as shown in [Figure 67](#).

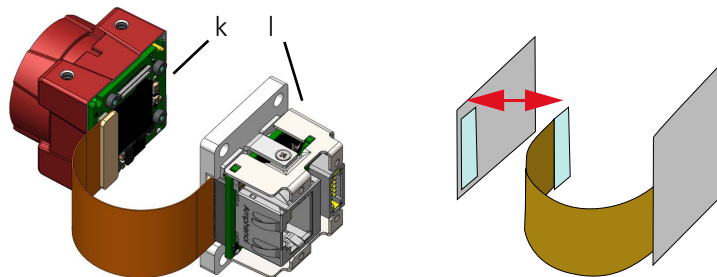

Figure 67: Aligning the connectors of the interface unit and the sensor unit

3. Connect the cable side FPC connector (m) of the interface unit to the camera side FPC connector (n) until it clicks. Now, connector (m, light green in [Figure 68](#)) is in touch (red oval) with the camera board surface.

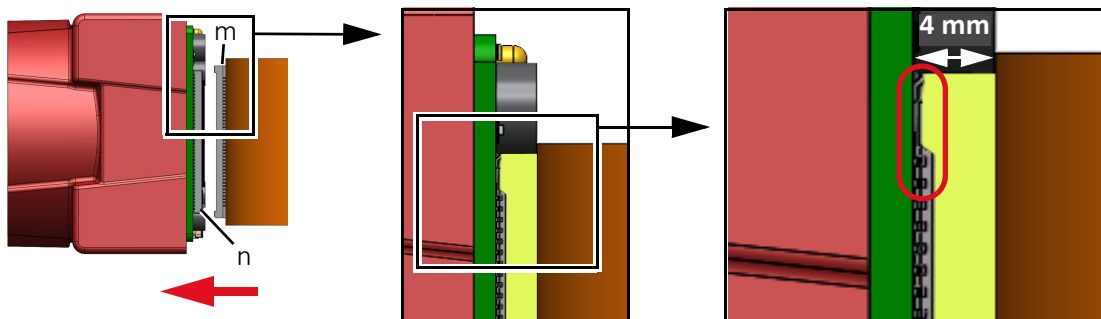

Figure 68: Connecting the interface unit to the sensor unit

Your Alvium G1 BL camera is prepared for operation

Adapting maximum torque values

This is a general example. Use the corresponding values for your camera. The total screw length composes of the mounting holes length and the height of your mounting base. For using less than the recommended length of thread engagement, calculate maximum torque as follows

$$\frac{\text{Current length of thread engagement}}{\text{Length of thread engagement in table}} \times \text{Torque in table} = \text{Current torque}$$

Example for a length of thread engagement of **1.4 mm** instead of 1.7 mm:

$$1.4 \text{ mm} / 1.7 \text{ mm} \times 0.17 \text{ Nm} = \mathbf{0.14 \text{ Nm}}$$

Thread group	Thread position	Thread type	Total protrusion	Length of thread engagement	Maximum torque
b	Front mounting	M2	2 mm	1.7 mm	0.17 Nm
b	Front mounting	M2	2 mm	1.4 mm	0.14 Nm

Table 105: Adjusting maximum torque values

To ensure that the screws do not become loose over time, we recommend you to use means for securing screws, such as screw locking varnish.



Tripod and mounting adapters

See www.alliedvision.com/en/support/accessory-documentation for the

- **Alvium Tripod Adapter** used for all Alvium cameras
- **Alvium G1 Mounting Adapter**, using the same holes as Mako cameras to connect to mounting bases.

Mounting the lens

Observe the following notes before you mount lenses to Alvium G1 cameras.



CAUTION

Injury by falling cameras or lenses

A falling camera or lens can cause injury.

- Ensure proper mounting of cameras and lenses, especially for dynamic applications.
- Mount cameras as described in the instructions.
- Use a lens support for heavy lenses.



CAUTION

Risk of cuts by sharp edges of lens mounts

The threads of the lens mount can have sharp edges.

Be careful when mounting or unmounting lenses.



NOTICE

Damage to sensor or optics by unsuitable lenses

The sensor, filter, or lens can be damaged if a lens exceeding maximum protrusion is mounted to the camera.

- Use lenses only up to the specified maximum protrusion.
- S-Mount lenses must be screwed into the camera less than maximum protrusion (11.0 mm).
- Avoid short S-Mount lenses falling into the camera.

Mounting and focusing S-Mount lenses



Allied Vision S-Mount lenses

For technical data of Allied Vision S-Mount lenses with dedicated operating instructions, see the S-Mount Lenses User Guide at www.alliedvision.com/fileadmin/content/documents/products/accessories/lenses/Allied_Vision/User_Guide/S-Mount-Lenses_User-Guide.pdf.

This section instructs how to use S-Mount lenses with your camera safely. S-Mount lenses are screwed into the mount to adjust focus. Vibration moves lenses out of position. Several techniques can be used to fasten S-Mount lenses in focus. We recommend using fixing nuts. See instructions in this section.



Drawings of cameras and fixing nuts

Drawings in the instructions are schematic.

Several manufacturers offer various types of S-Mount fixing nuts. The type shown in the instructions drawings is an example.

We recommend using pinch nose pliers to tighten fixing nuts.

Figure 69 shows how fixing nuts lock S-Mount lenses.
Follow the instructions to lock the lens in focus position.

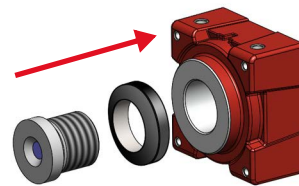

Figure 69: Fixing nut locking an S-Mount lens

NOTICE
Damage to sensor or optics by improper handling

If an S-Mount lens is screwed against the sensor, sensor and lens can be damaged.

- Screw in the lens at 11.0 mm maximum protrusion.
- Follow the instructions carefully.

Determining the allowed range for the position of the lens

1. Measure the length of the lens.
2. Calculate: $a = c - b$
 a: length of the mounted lens, measured from lens mount front flange
 b: maximum protrusion (11.0 mm)
 c: length of the lens

See [Lens mounts and maximum protrusion](#) on page 167.

3. Set a gauge to the length of (a).

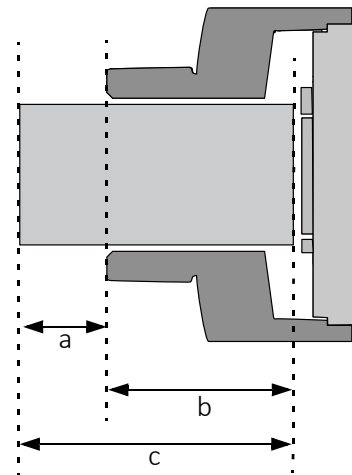

Figure 70: S-Mount lens and maximum protrusion

Mounting the fixing nut to the lens

4. Screw the fixing nut clockwise onto the lens until you can hold the front part (d) of the lens with your finger tips.

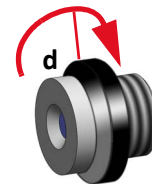

Figure 71: Lens and fixing nut

Focusing the lens

5. **Checking (a) with a gauge**, slowly screw the lens clockwise into the lens mount until the image is roughly in focus.
6. Slowly screw the lens in and out until you have found most accurate focus.

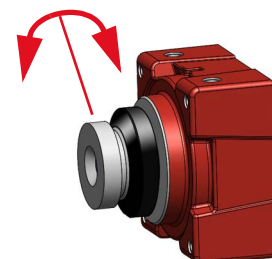

Figure 72: Adjusting focus

NOTICE
Damage to lens threads and fixing nut by excessive force

If the fixing nut is screwed with too much force, threads are worn out and the lens cannot be locked anymore.

Screw fixing nuts hand tight to keep the lens in a fixed position.

Locking focus

Pinch nose pliers are used to screw the fixing nut:

7. Holding the lens in position with one hand, screw the fixing nut clockwise against the lens mount until you feel the lens is locked.

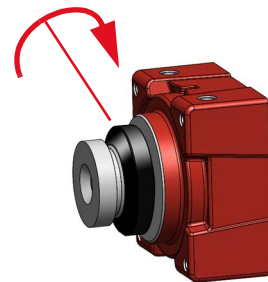

Figure 73: Tightening the fixing nut

Checking focus is set and locked properly

8. Check No.1: Try to rotate the lens with little strength in both directions to ensure the lens is safely locked in position.

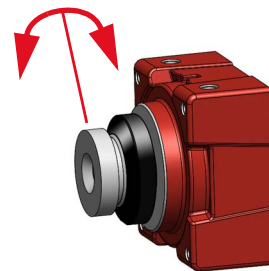

Figure 74: Checking lens is safely locked

9. Check No. 2: S-Mount thread allows a slightly tilted lens position. In this case, focus for a common object plane varies over the image plane.

If focus is constant over the image plane, you are done.

If focus varies over the image plane, the lens is tilted. Continue with 10.

10. Loosen the fixing nut.

11. Continue with 6.

The lens is locked in focus and ready for operation.

Configuring the host computer



Please consider

Alvium G1 cameras require different hardware and settings than 1000BASE-T cameras like Mako or Prosilica GT cameras. We suggest you:

- Build up general knowledge: [Performance and troubleshooting](#) on page 237.
- Find solutions for issues: [Troubleshooting common issues](#) on page 254.

Alvium G1 cameras can operate on 100 and 1000BASE-T NICs. Requirements to reach the maximum camera frame rate:

- 1000BASE-T speed PCI Express NIC **on Desktop PCs**
- Jumbo Packet support for minimum 9,000 bytes. See [Enabling Jumbo Packets](#) on page 210.
- Enable Ethernet Flow Control on NICs and switches, see [NIC driver settings](#) on page 239.

Recommendations:

- Use only one camera per network port. For than one camera, use additional NICs or NICs with more than one port.
- Disable all unused NIC services and protocols (for example, activate only filter drivers for IPv4 and GigE).
- You can select between Fixed Link Speed and Auto Negotiation for the NIC driver's link speed settings.
 - **Fixed Link Speed:** If you set a link speed not supported by the camera, the link is not negotiated. Alvium G1 cameras support 1 Gbit/s for full performance or 100 Mbit/s for host systems that do not support 1 Gbit/s.
 - **Auto Negotiation:** We recommend using Auto Negotiation. The maximum link speed supported by the host system and the camera is set automatically. Therefore, the common link speed for the camera and host system may be lower than the maximum supported link speed of one of the two.



NOTICE

Network security

If cameras are used on mixed-use networks (with printers, Internet, and email), the network security may be affected, the camera performance as well.

- Use cameras only in trusted networks as required by the GigE Vision protocol.
- Check with your network administrator if required for network configuration.

Installing the NIC driver

Install the NIC driver from your network card manufacturer if available. If no installation application is provided, update the driver manually.

Linux: Updating the driver manually

Follow the instructions by the NIC manufacturer.

Windows: Updating the driver manually

1. Open the **Device Manager** with administrator permission.
2. Under **Network Adapters**, locate the Ethernet network adapter, right-click the entry, and select **Update Driver Software** in the menu.
3. Select the **Search automatically for updated driver software** or **Browse my computer for driver software**.
4. Click **Close** after the driver has been installed.

IP settings

After the initial NIC hardware installation, connect the NIC directly to the camera. The default configuration assigns an IP address automatically using the LLA (Link-Local Address) range of 169.254.xxx.xxx or an address defined by the DHCP (Dynamic Host Configuration Protocol) server, if present. This setup is a typical solution for single-camera operation or multiple cameras connected to the same NIC.

If you are going to operate multiple cameras on different networks, you can use the following configuration as a template.

All network devices (such as NICs, hubs or GigE cameras) require unique IP addresses. But connected devices must share the same address space. In the example shown in [Table 106](#), 3 cameras are connected to a common host PC, using 2 separate NICs. The address space for NIC 1 is 192.168.**100**, for NIC 2 it is 192.168.**101**:

Device	IP address	Subnet mask	Default gateway
NIC 1	192.168.100.1	255.255.255.0	Blank
Camera 1 connected to NIC 1	192.168.100.2	255.255.255.0	Blank
NIC 2	192.168.101.1	255.255.255.0	Blank
Camera 2 connected to NIC 2	192.168.101.2	255.255.255.0	Blank
Camera 3 connected to NIC 2	192.168.101.3	255.255.255.0	Blank

Table 106: Static IP addresses for NICs and connected cameras



Applying advanced IP settings for cameras

See [Configuring IP settings](#) on page 211 for instructions.

Adjusting the NIC driver settings

The NIC should be adjusted to improve system performance when using Alvium G1 cameras. This is achieved by minimizing the CPU usage in order to avoid dropped or resent packets.

Edit the NIC driver properties according to the values in the following table. The names and availability of the properties listed may vary depending on

- NIC manufacturer
- Operating system
- Camera model.

Property	Value
Packet Size, Frame Size, Jumbo Packet, or Maximum Transmission Unit	Maximum value configurable
Interrupt moderation	Enable
Interrupt moderation rate	Start with NIC's default value and experiment with different setting if required
Receive buffers	Maximum value configurable

Table 107: NIC settings

Default packet size

At startup, Alvium G1 cameras have a default packet size of 576 bytes on the device stream channel. This enables optimum backward compatibility when ancient network hardware is used or when the network packets are tunneled through other protocols. Consider, that this packet size creates a large overhead on the host, which does not allow the full throughput most likely.

Enabling Jumbo Packets

We recommend you to increase the packet size to the maximum value supported by all parts of the system. The effective packet size should be at least around **9,000 bytes**. Configure the NIC settings as follows:

1. Open the **Device Manager** with administrator permission.
2. Under **Network Adapters**, locate the Ethernet network adapter, right-click the entry, and select **Properties** in the menu.
3. Adjust the corresponding settings to match the values required in [Table 107](#).



Easy adjustment of the packet size

We recommend using **Vimba X** to adjust the packet size on connected cameras. See the **Vimba X** documentation included in the download at www.alliedvision.com/en/products/software/vimba-x-sdk.

Connecting the camera to the host

Use a Category 6 or higher rated Ethernet cable to connect the Alvium G1 camera to the NIC. Crossover cabling is not required but does work. The camera has circuitry to determine if a crossover cable is being used.



We recommend Category 6 (CAT6) or higher rated Ethernet cables for Alvium G1 cameras. A different rating may not sustain peak interface bandwidth; leading to lost connectivity or dropped frames coming from the camera.

After you have installed the **Vimba X**, including **Vimba X Viewer** or third-party application to your host computer, connect your Alvium G1 camera via an Ethernet cable. If your camera is not PoE powered, connect the TFM I/O cable to power the camera.

Configuring IP settings



Examples for IP settings

See [IP settings](#) on page 209 for details.

1. Open **Vimba X Viewer**.
2. Click **IP** (a) to open the **IP Widget**.
The window of the IP Widget opens.
3. Select the camera (b) to be configured.
4. In the IP Widget, select **Persistent IP** (c).
5. Enter IP address settings (d).
6. Click **Write** (e) to apply settings for the camera.

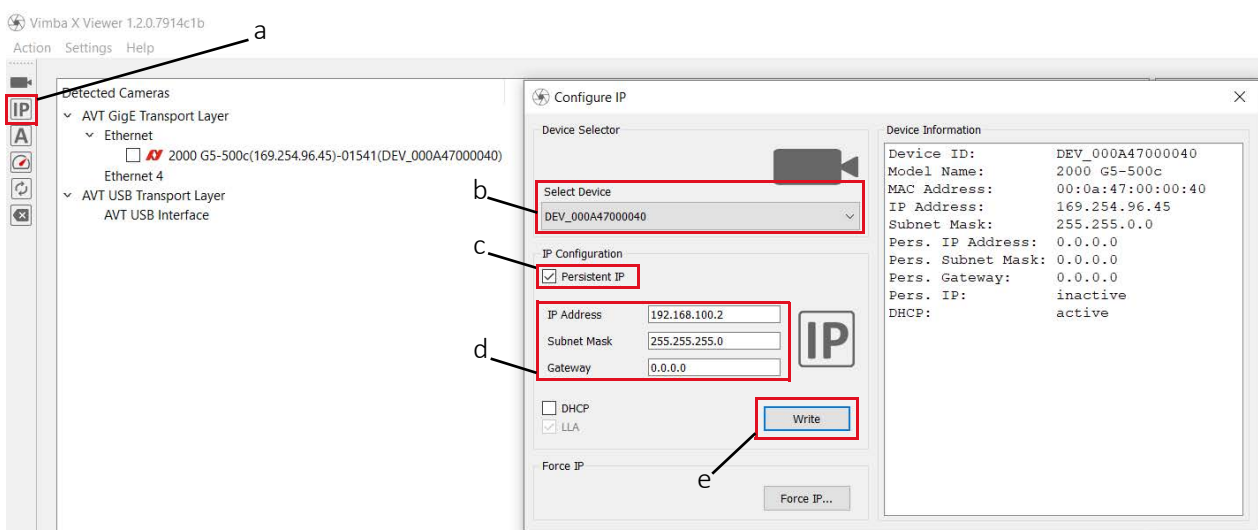

Figure 75: Configuring IP settings with the IP Widget of Vimba X Viewer

7. Restart the camera.



The camera is not recognized

Of course, the camera will not be recognized any more until you have changed system IP settings in step 9.

8. Continue for the other cameras from step 2. to 7.
9. Change system IP settings.

Powering up the camera

Powering the camera via I/O port

When cameras are powered by both the 10-pin TFM I/O port and by PoE, power by the I/O port is used.



NOTICE

Damage to the camera electronics

- **Never use PoE and external power at the same time.** Otherwise, the camera is damaged.
- Use only DC power supplies that comply with the camera specifications and that have insulated cases.
- When using external power supplies, pay attention to the alignment marks on the 10-pin TFM connector and socket. Inserting the plug in the wrong orientation might cause damage to the camera electronics and peripherals.
- For all cable connections, use only shielded cables to avoid electromagnetic interference.



External power supply

For the 13870 10-pin TFM power supply, see www.alliedvision.com/en/support/accessory-documentation.

Powering the camera via PoE



NOTICE

Damage to the camera or connected peripherals

Damage to the camera and connected peripherals can occur if PSE is not galvanically isolated from mains and other electrical connections towards the camera (other than Ethernet signals and shield ground).

- **Never use PoE and external power at the same time.** Otherwise, the camera is damaged.
- Only use IEEE802.3af/at compliant PSE equipment to power the camera via PoE.
- Ensure the PSE is galvanically isolated from mains and all other electrical connections towards the camera.

Please note the following when using PoE NICs and PoE injectors with Allied Vision PoE-capable Alvium G1 cameras:

Feature	Specification
Supported standard	IEEE 802.3af, Power Class 0
Cable category	We recommend you to use Category 6 cables for better performance.
PSE	Power Sourcing Equipment (PSE) must support data over all 4 pairs and must be rated for the intended link speed.

Table 108: Powering the camera via PoE

Software for your Alvium G1

Allied Vision software

Software packages provided by Allied Vision are free of charge and contain such as:

- Drivers
- SDK for camera control and image acquisition
- Examples based on the provided APIs of the SDK
- Documentation and release notes
- Viewer application to operate and configure the cameras



Download **Vimba X** from www.alliedvision.com/en/products/software/vimba-x-sdk. After installing, documentation is located in the **Vimba X** program folder.

Third-party software

In addition to the software provided by Allied Vision, numerous GigE Vision Standard compliant third-party software options can be used to extend functionalities, such as image processing and video recording.

Allied Vision's **Vimba X** is based on the GenICam standard. GenICam-based third-party software automatically connects with Vimba's transport layers.



Cognex VisionPro

Alvium GigE cameras comply with GigE Vision Standard V2.2.

The **eBus Universal Pro Driver** in **Cognex VisionPro** supports a previous V1.x version. Therefore, it cannot be used with Alvium cameras.

Please check if you can use **Vimba** (instead of **Vimba X**) and **Vimba Cognex Adapter for VisionPro** included in the download of **Vimba SDK** to replace the eBus driver.

We intend to provide an updated version of this software for use with **Vimba X**. Until then, if **Vimba** does not support all features required by your application, please contact support at www.alliedvision.com/en/about-us/contact-us/technical-support-repair/-/rma.

Camera interfaces



This chapter includes:

I/Os: Precautions	215
Interface back panel	216
I/O connector pin assignment	217
I/Os and GPIOs	218
G1 BL sensor unit back panel.....	223
Status LEDs	224

I/Os: Precautions



NOTICE

Damage to the camera or connected peripherals

The PoE implementation is non-isolated.

Therefore, when the camera is connected to a PoE-capable Ethernet port:

- Only connect the pins 3, 4, 5, 6 and 10 (isolated I/Os).
- **Do not** connect any other pins of the TFM connector.



NOTICE

Damage by reverse polarity

If Alvium G1 cameras are externally powered with reverse polarity, the cameras can be damaged.

Power Alvium G1 cameras according to the specifications described in this chapter.



NOTICE

Damage by serial communication voltage levels

If you are using serial communication (UART, similar to RS232), keep voltage levels in the range defined in [Table 110](#) on page 217. Typical RS232 voltage levels (such as ± 10 VDC) are not supported without external circuitry.



I/O cables maximum length

The maximum length for I/O cables must not exceed 30 m.



Signal level

Consider this when you connect external devices to your camera, for example, to trigger lighting:

- The default signal level for isolated GPO2 is low at camera startup.
- The default signal level for non-isolated GPIO0 and GPIO1 is high at camera startup.

Use the `LineInverter` feature to configure I/Os and GPIOs for your needs.

Interface back panel



Sensor unit's back panel for Alvium G1 BL

The back panel in [Figure 76](#) is used for standard Alvium G1 Closed Housing cameras. For the sensor unit's back panel of Alvium G1 BL cameras, see [G1 BL sensor unit back panel](#) on page 223.

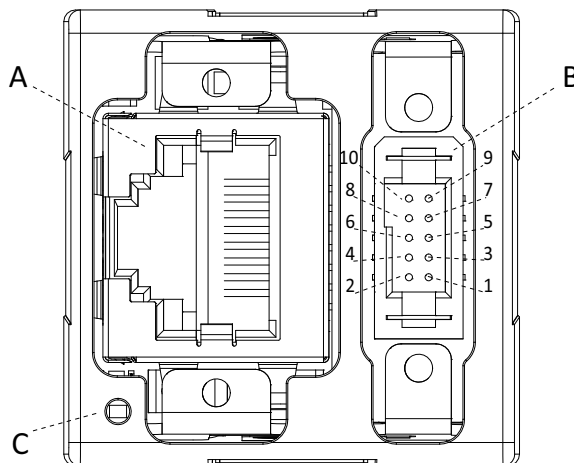

Figure 76: Interface back panel > standard G1 Closed Housing, G1 BL interface unit

	Description
A	Ethernet port
B	I/O connector
C	LED

Table 109: Ports and LED



I/O connector

The I/O connector is 10-pin TFM connector type is an TFM-105-02-L-D-WT.

We recommend using cables by Allied Vision. If you are going to manufacture your own cables, see SFSD, ISDF, or SFM series at www.samtec.com.

Even though the TFM connectors' product naming differs between Alvium G1 and Alvium G5, both cameras use the same mating connectors.



I/O cables

For I/O cables at different lengths with 10 Pin TFM to open ends, see www.alliedvision.com/en/support/accessory-documentation.

I/O connector pin assignment

The general purpose I/O port uses a 10-pin TFM connector on the camera side.

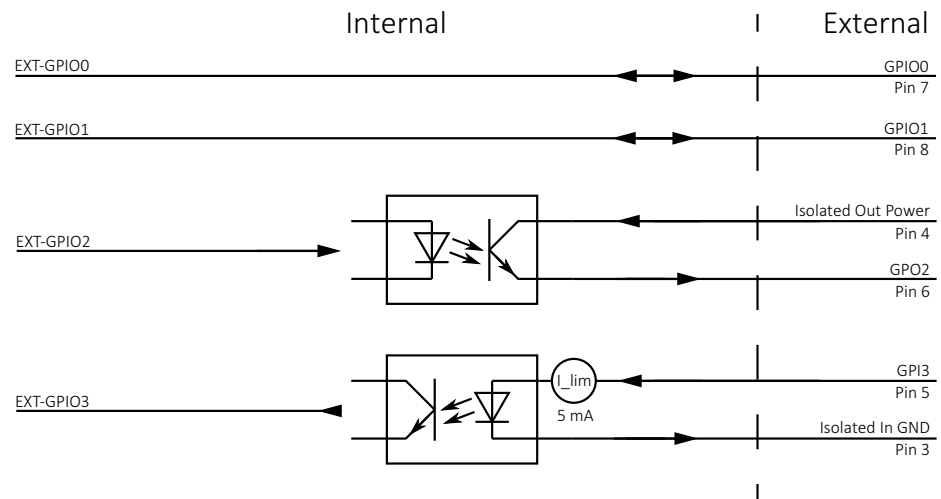

Figure 77: TFM I/O connector pin assignment

Pin	Signal	Direction	Level	Description
1	PWR-GND	In	0 VDC	Supply Ground
2	PWR-IN	In	10.8 to 26.4 VDC	Power supply voltage
3	OPTO-IN-GND	In	0 VDC	Isolated input ground
4	OPTO-OUT-PWR	In	max. 30 VDC	Power for isolated output
5	GPI3	In	$U_{in}(\text{high}) = 3.0 \text{ to } 24.0 \text{ V up to } 36 \text{ VDC}$ with $3.3 \text{ k}\Omega$ ext. resistor in series $U_{in}(\text{low}) = 0 \text{ to } 1.0 \text{ V}$	Isolated Input
6	GPO2	Out	Open emitter, max. 20 mA	Isolated Output
7	GPIO0	In/Out	$U_{in}(\text{low}) = -0.3 \text{ to } 0.8 \text{ VDC}$ $U_{in}(\text{high}) = 2.0 \text{ to } 5.5 \text{ VDC}$ $U_{out}(\text{low}) = 0 \text{ to } 0.4 \text{ VDC}$ $U_{out}(\text{high}) = 2.4 \text{ to } 3.3 \text{ VDC at max. } 20 \text{ mA}$	Non-isolated I/O (LVTTTL)
8	GPIO1	See Pin 7, GPIO0		
9		Reserved		
10	C-GND	PWR	0 VDC	Chassis ground and shielding

Table 110: TFM I/O connector pin assignment

I/O use for UART

Table 111 shows which values must be selected to control I/Os using LineSelector.

Signal	LineSelector (GenICam)	UART line
EXT-GPIO 0	Line0	UART Tx
EXT-GPIO 1	Line1	UART Rx
EXT-GPIO 2	Line2	Not applicable
EXT-GPIO 3	Line3	Not applicable

Table 111: Value settings to control I/Os using the LineSelector feature



Feature descriptions and firmware downloads

Alvium Features Reference: www.alliedvision.com/en/support/technical-documentation/alvium-gige-documentation

Firmware downloads: www.alliedvision.com/en/support/firmware-downloads.

I/Os and GPIOs

Isolated input description

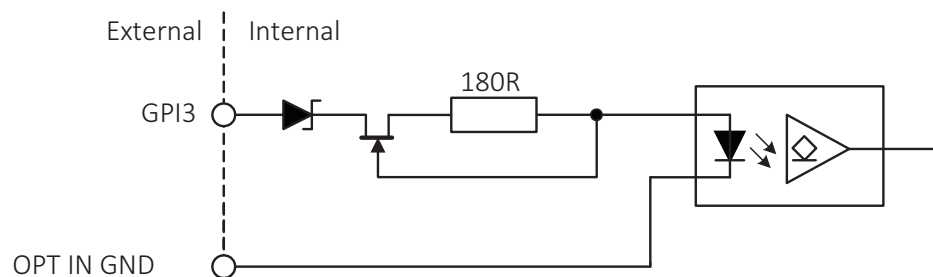

Figure 78: Input block diagram

The input can be connected directly to the system for voltages up to 24 VDC. An external resistor is not necessary.

Levels

Parameter	Value
U_{in} (low)	0 to 1.0 V
U_{in} (high)	3 to 24 V
Current (constant-current source)	3 to 4 mA

Table 112: Input parameters

Minimum pulse width

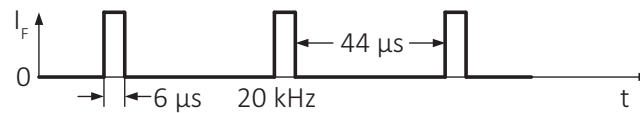

Figure 79: Minimum pulse width

Test conditions

The input signal was driven with 3.3 V and no external additional series resistor.

Isolated output description

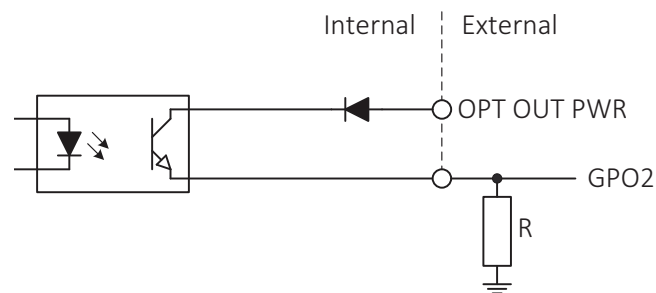

Figure 80: Output block diagram

Levels



NOTICE

Damage to the camera by high output current or voltage

Exceeding the maximum output voltage or current can damage the camera. Keep maximum output voltage below 24 VDC and output current below 20 mA.

Isolated out power	Resistor value ¹	
5 V	1.0 kΩ	at ~ 5 mA minimum required current draw
12 V	2.4 kΩ	
24 V	4.7 kΩ	

¹ A resistor is required when GPO2 is connected to a device with a high impedance < 5 mA draw.

Table 113: Isolated out power and external resistor

Switching times

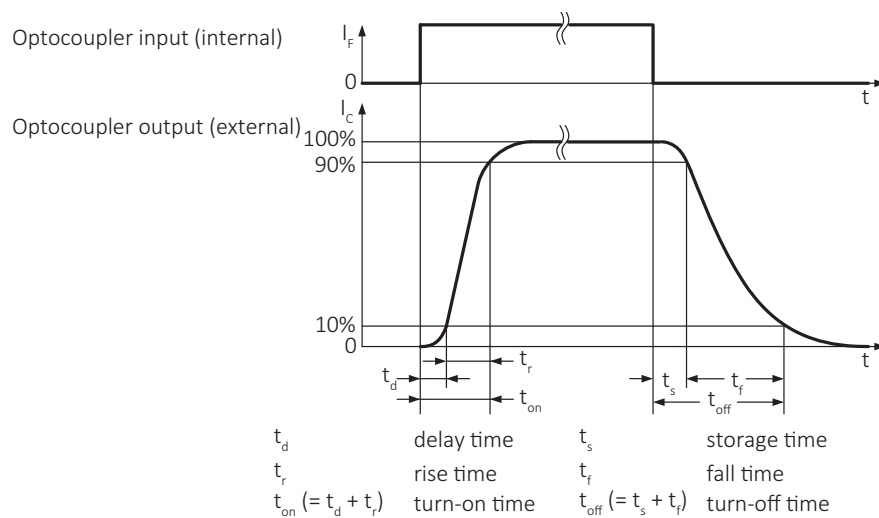

Figure 81: Output switching times

Parameter and value	
$t_d \approx 1 \mu\text{s}$	$t_s \approx 26 \mu\text{s}$
$t_r \approx 1 \mu\text{s}$	$t_f \approx 21 \mu\text{s}$
$t_{on} = t_d + t_r \approx 2 \mu\text{s}$	$t_{off} = t_s + t_f \approx 47 \mu\text{s}$ (t_{off} can deviate by $\pm 5 \mu\text{s}$)

Table 114: Output parameters

Test conditions

Output: external 2.4 kΩ resistor to GND, isolated out power set to 12 V.



Higher external values increase the times in the previous table.

Non-isolated GPIOs description

The camera has two non-isolated GPIOs that can be configured by software to act as inputs or outputs.

Alvium G1 GPIOs use the push-pull technology to switch the signal level between low and high. For low levels, the signal is "pulled" down towards ground level. For high levels, the signal is "pushed" up towards VCC level.

Alvium G1 GPIOs feature the CMOS push-pull output drivers and Schmitt trigger inputs with an internal pull-up resistor and a filter circuit, shown in [Figure 82](#). The push-pull GPIOs are able to source or sink current from an external pin.

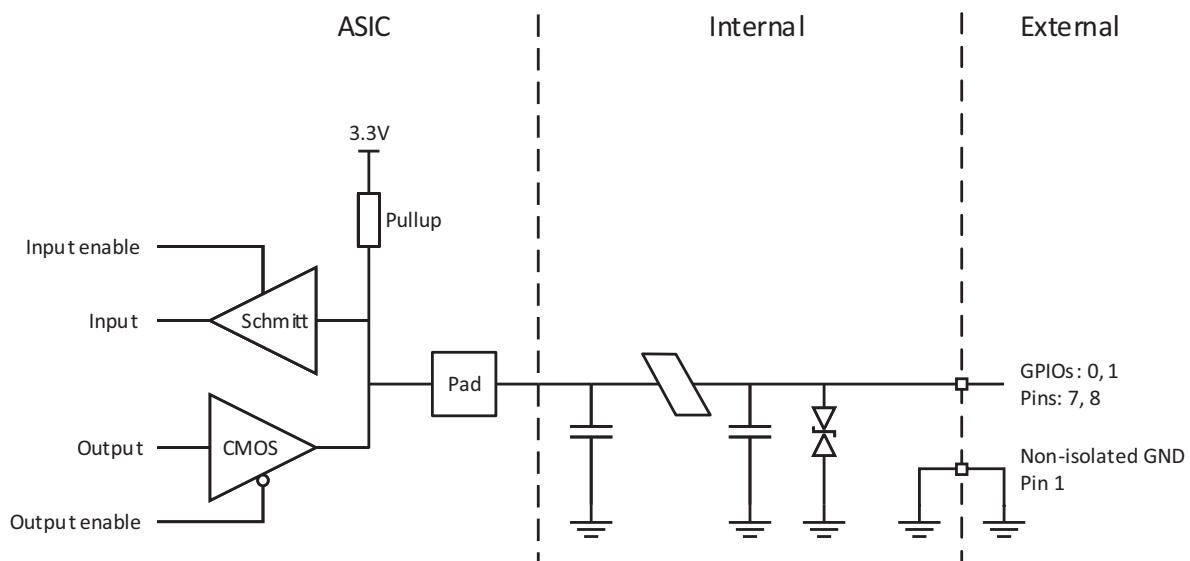

Figure 82: GPIOs block diagram

Input levels

The GPIOs can be connected directly to the system controlling the camera for voltages up to 5.5 VDC. An external resistor is not necessary.



NOTICE

Damage to the camera by high input voltage

Exceeding the maximum input voltage can damage the camera.
Keep maximum input voltage below 5.5 VDC.

Parameter	Value
U_{in} (low)	-0.3 to 0.8 VDC
U_{in} (high)	2.0 to 5.5 VDC
Undefined levels	0.8 to 2.0 VDC

Table 115: GPIOs as input, voltage levels

Output levels



NOTICE

Damage to the camera by high output current

The camera can be damaged when connected to a device that exceeds the specified maximum current or voltage. Keep the maximum current below 12 mA per output.

Parameter	Value
External output voltage U_{out} (low, Off state)	0 to 0.4 VDC
External output voltage U_{out} (high, On state)	2.4 to 3.3 VDC
Undefined levels	0.4 to 2.4 VDC
Maximum external output voltage	3.3 VDC
Maximum output current	12 mA

Table 116: GPIOs as output, current and voltage levels



Output voltage for U_{Out} (high) = On state

The voltage level in the On state depends on the load current. Higher currents yield lower voltage.

G1 BL sensor unit back panel



Back panel for standard Alvium G1 Closed Housing

The back panel in [Figure 83](#) is used for the sensor unit of Alvium G1 BL cameras. For the interface panel of standard Alvium G1 Closed Housing cameras, see [Interface back panel](#) on page 216.

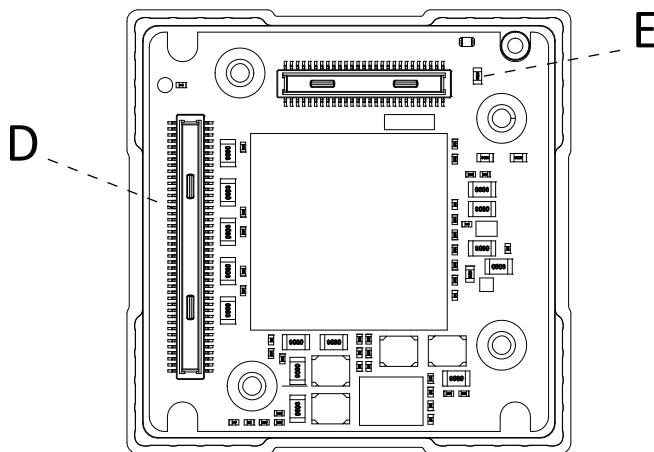

Figure 83: Back panel of the G1 BL sensor unit

	Description
D	Hirose DF 40 Hirose connector
E	LED

Table 117: Ports and LED

Status LEDs

Alvium G1 cameras have LEDs to signal in yellow, green, or red color.



LED settings

You can define LED settings with the `DeviceIndicatorLuminance` feature:

- A value of `10` enables LED signaling at the highest luminance level.
- Values below `10` reduce the luminance level.
- `0` disables LED signaling.

LED codes



LED codes	Behavior	Status
	Continuously active	Camera is initializing
	1 flash per second	Camera is operational
	Continuously active	Error state

Table 118: LED codes



Yellow LED color

With yellow, a green and a red LED are active in parallel. Seen directly from behind, this appears as yellow; seen from an angle, you can see green and red separately.

Error state

If the camera signals an error, try the following to get the camera back to normal operation:

- Restart the camera.
- Should this fail, please contact support at www.alliedvision.com/en/about-us/contact-us/technical-support-repair/-rma.

Triggering and timings



This chapter includes:

Trigger signal flow	226
Trigger latency	226
Triggering with rolling shutter cameras	227

Trigger signal flow

Figure 84 shows a general diagram for the trigger signal flow. The external signal can be a physical source, such as light barrier as hardware trigger or a software trigger. This external signal starts the exposure of a frame. The end of exposure starts the readout. High levels show the active state of a signal.



Feature descriptions and firmware downloads

Alvium Features Reference: www.alliedvision.com/en/support/technical-documentation/alvium-gige-documentation

Firmware downloads: www.alliedvision.com/en/support/firmware-downloads.

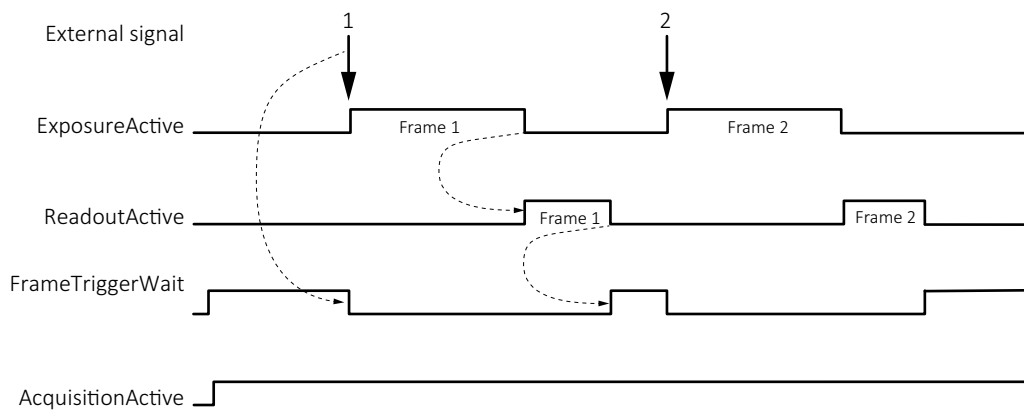

Figure 84: Schematic trigger signal flow

Term	Description
External signal	Electrical trigger signal starting the signal flow
<i>ExposureActive</i>	Exposing a frame
<i>ReadoutActive</i>	Reading out a frame
<i>FrameTriggerWait</i>	Waiting for a trigger
<i>AcquisitionActive</i>	Enables frame acquisition: Expose, read out data, or wait for triggers.

Table 119: Trigger signal flow terms

Trigger latency

In theory, a trigger creates an immediate response of the camera, depending on the cable length. In practice, the computer may add a delay that is mostly unpredictable, especially on Windows systems. In addition, camera electronics and sensors have a delay.

We recommend you to trigger on the rising edge for the fastest reaction time.

Electronic rolling shutter (ERS) cameras in this document also have exposure delay, depending on camera settings, see [Triggering with rolling shutter cameras](#) on page 227. Electronic rolling shutter is commonly called rolling shutter.

Triggering with rolling shutter cameras

This section describes triggering behavior for **Alvium G1-500m/c and G1-2050m/c** cameras with rolling shutter sensor. Figure 85 shows how an external signal triggers exposure and readout for cameras with rolling shutter sensors. Like for global shutter sensors, readout has a constant duration, acquisition must be active to enable exposure, the end of exposure starts readout.

ERS sensors run in cycles where **readout area** equals **exposure area**. Overlapping triggering is not supported. If exposure time is shorter than readout time, exposure starts with a delay:

$$\text{Exposure start delay} = \text{exposure area} - \text{exposure time.}$$

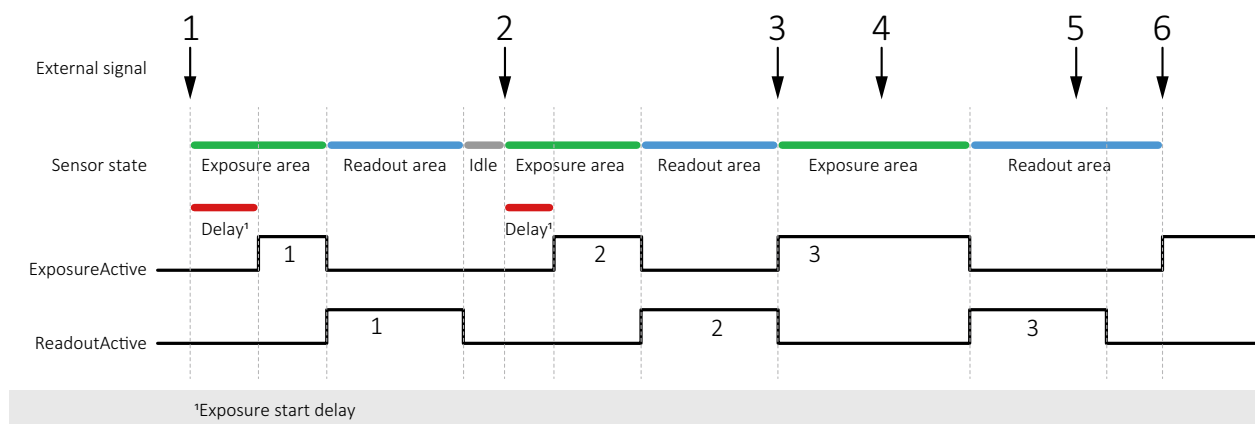

Figure 85: Triggering rolling shutter cameras

No	Conditions	Results
1	Exposure time is shorter than readout time.	Trigger 1 starts exposure 1 with a delay
2	Exposure time is shorter than readout time, but longer than for exposure 1.	Trigger 2 starts exposure 2 with a delay shorter than for exposure 1.
3	Exposure time is longer than readout time	Trigger 3 starts exposure time without a delay. Because the exposure area is longer, also the readout area is longer than for triggers 1 and 2
4	Exposure area is ongoing.	Trigger 4 is ignored.
5	Readout area is ongoing	Trigger 5 is ignored.
6	Readout area is finished. Exposure time is longer than readout time.	Trigger 6 starts exposure 6 without a delay

Table 120: Triggering results versus conditions



TriggerSelector values for rolling shutter cameras

Cameras with rolling shutter **can** be triggered using *AcquisitionStart*, *AcquisitionEnd*, or *FrameStart* for **TriggerSelector**.

Cameras with rolling shutter **cannot** be triggered using *ExposureStart* or *ExposureEnd* for **TriggerSelector**.

Ignored triggers

Alvium G1-500m/c, G1-1240m/c, and G1-2050m/c

Changing parameters while acquisition is active leads to ignored triggers until the parameters get active.

Trigger features and UserSetDefault

See [Trigger features and UserSetDefault](#) on page 172.

Image data flow



This chapter includes:

Image data flow diagram	230
FPNC support	231

Image data flow diagram

Figure 86 shows image data processing for Alvium G1 cameras in general.

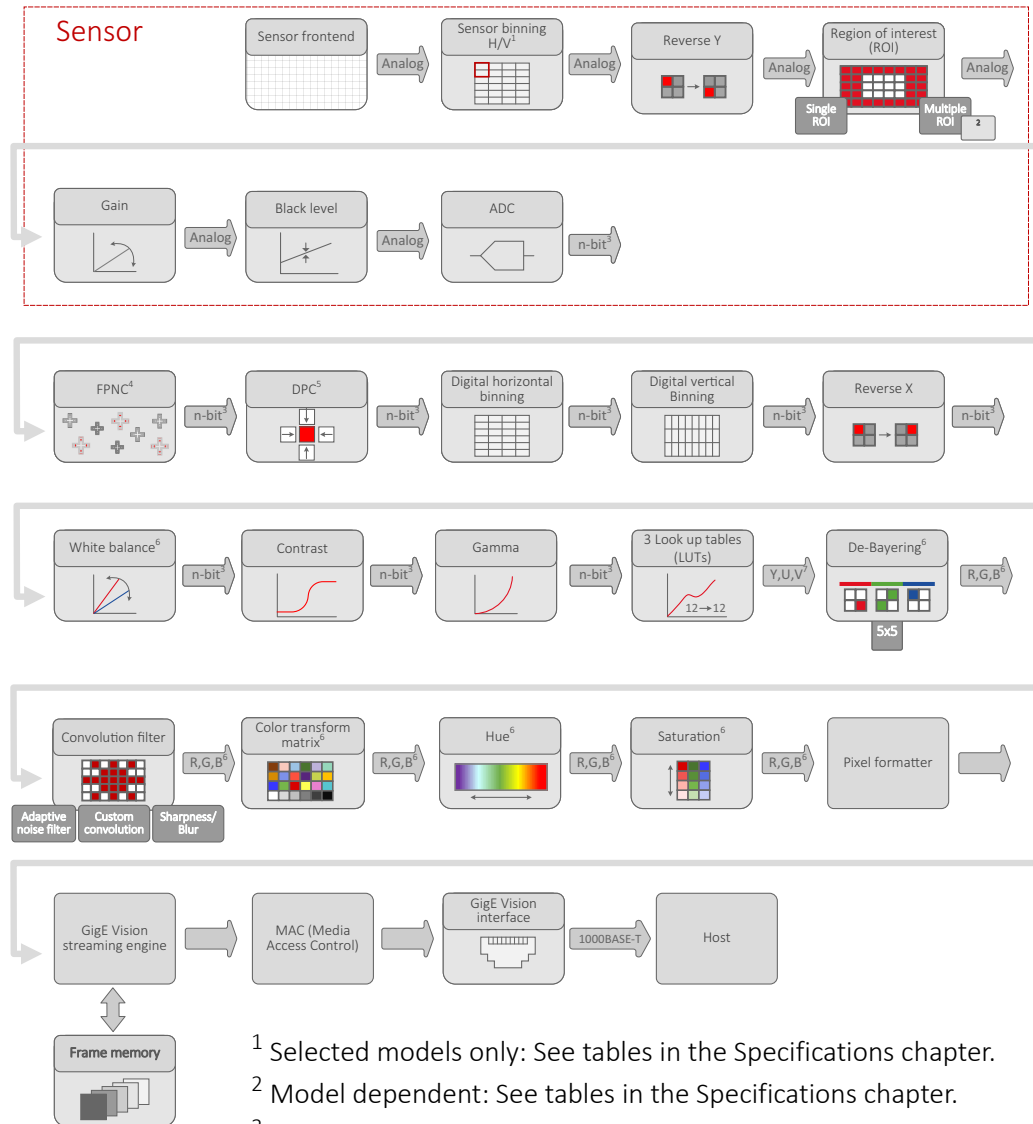

- ¹ Selected models only: See tables in the Specifications chapter.
- ² Model dependent: See tables in the Specifications chapter.
- ³ Model dependent: See ADC bit depths in the Specifications chapter.
- ⁴ Factory preset for FPNC = Fixed Pattern Noise Correction. See [FPNC support](#) on page 231 for supported models.
- ⁵ Factory preset for DPC = Defect pixel correction
- ⁶ Color models only

Figure 86: Image data flow of Alvium G1 cameras

Feature descriptions and firmware downloads

 Alvium Features Reference: www.alliedvision.com/en/support/technical-documentation/alvium-gige-documentation

 Firmware downloads: www.alliedvision.com/en/support/firmware-downloads.

FPNC support

Table 121 shows which Alvium 1800 U models support FPNC (Pixed pattern noise correction):

Alvium model	Sensor	FPNC support	Alvium model	Sensor	FPNC support
G1-030 VSWIR	IMX991	-	G1-510	IMX548	✓
G1-040	IMX287	✓	G1-811	IMX546	✓
G1-130 VSWIR	IMX990	-	G1-812 UV	IMX487	✓
G1-131	EV76C560	✓	G1-895	IMX267	-
G1-158	IMX273	✓	G1-1236	IMX304	✓
G1-192	EV76C570	✓	G1-1240	IMX226	✓
G1-234	IMX249	-	G1-1242	IMX545	✓
G1-240	IMX392	✓	G1-1620	IMX542	✓
G1-500	AR0521	✓	G1-2040	IMX541	✓
G1-507	IMX264	✓	G1-2050	IMX183	-
G1-507 Pol	IMX264	-	G1-2460	IMX540	✓

Table 121: FPNC availability by camera model

Firmware update



This chapter describes how firmware is updated on Alvium G1 cameras.

Please note

You should update firmware only to change camera functions or fix known issues.

Consider: Any firmware update may not only add new features to a camera or fix known issues. It may also replace previous features or change camera characteristics. See firmware release notes for details.



Keep the camera connected

- Keep the camera and the computer running while you are executing a firmware update.
- If the camera is powered down during firmware update, it may get into a non-functional state. Recovery may not be possible.



Use only suitable firmware

If unsuitable firmware is used, the camera may get into a non-functional state.

- Only update to newer versions. Do not downgrade firmware to an older version, unless this has been explicitly communicated.
- We recommend updating the firmware to the next increment version only. Skipping versions may cause issues.

Firmware update with Vimba X

1. Download and install **Vimba X**.
The download includes Vimba X documentation.
2. Download the firmware (AVF file).



Downloads

- For **Vimba X**, see www.alliedvision.com/en/products/software/vimba-x-sdk.
- For firmware updates, see www.alliedvision.com/en/support/firmware.

3. Connect your Alvim camera to the host.
4. Execute the installer of the firmware updater.
The **Vimba X Firmware Updater** window opens, displaying your camera and the installed firmware version.
5. Continue with [Updating the firmware](#) on page 234.

Updating the firmware



Screenshots

The following instruction shows the firmware update on a **Linux** system. On **Linux** systems with other skins and on **Windows**, the GUI will look different.

The screenshots show an Alvium CSI-2 camera, but it applies to all interfaces.

1. Click **Open** to select the firmware for the update.

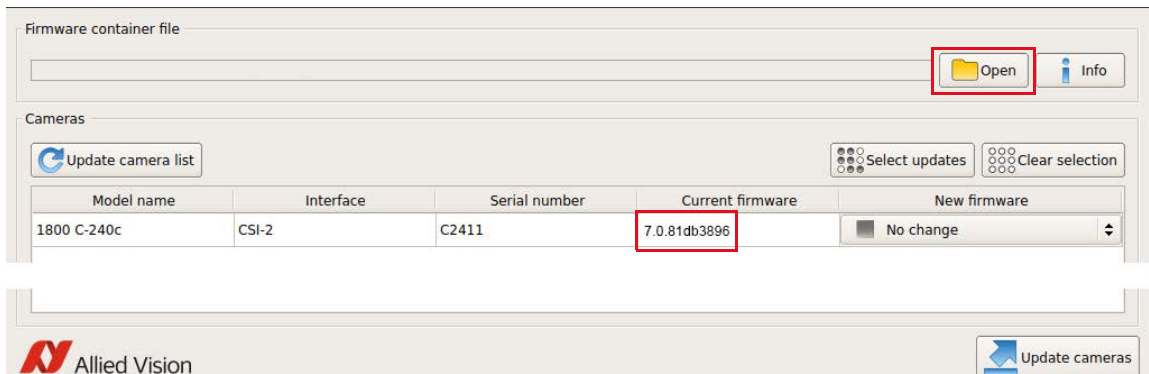

Figure 88: The camera and installed firmware are displayed

2. Select the firmware for the update from the drop-down menu.

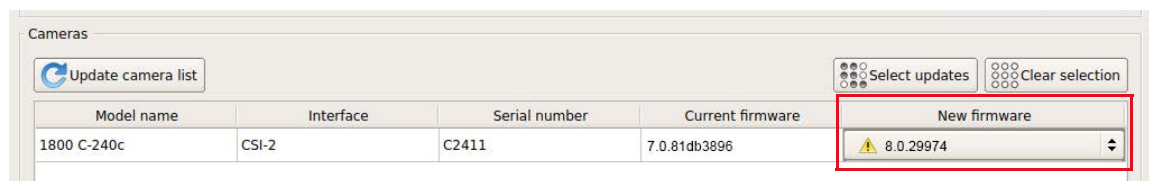

Figure 89: The firmware version is selected

3. Click **Update cameras**.



Figure 90: The update is being prepared

- Click **OK** to confirm.



Figure 91: The command to update the firmware is confirmed

The update progress is displayed.

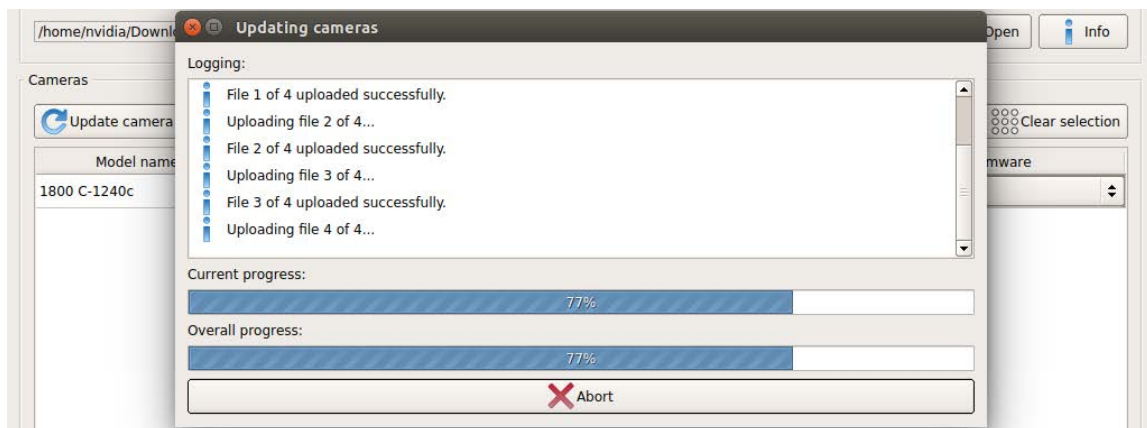

Figure 92: The update progress is displayed

- Click **Close** to confirm the completion of the update.

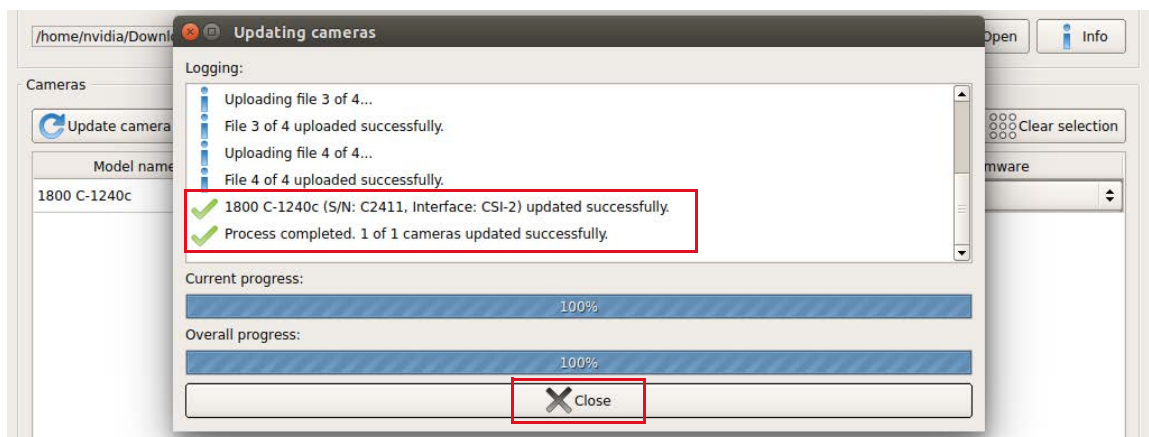

Figure 93: The update has been successfully completed

The camera is displayed with the updated firmware version.

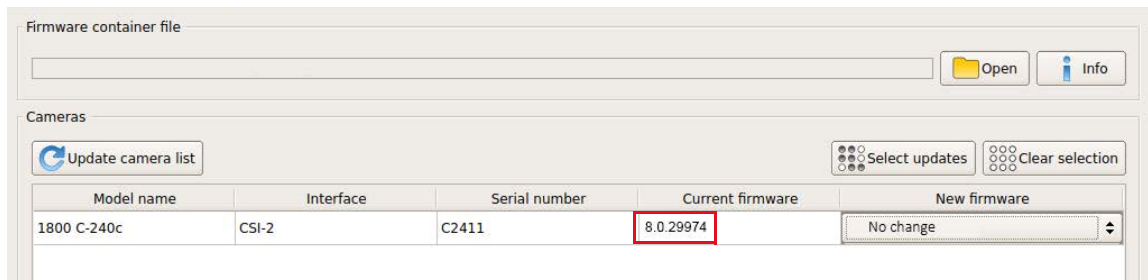

Figure 94: The updated firmware version is displayed

Error handling

If firmware update fails,

- The camera is not recognized by **Vimba X Viewer**.
- You can repeat the firmware update.

Should the firmware update not succeed, please contact support at www.alliedvision.com/en/about-us/contact-us/technical-support-repair-/-rma.

Performance and troubleshooting



This chapter includes:

Tips and tricks to connect 1000BASE-T	238
Optimizing performance	245
Reference system	252
Troubleshooting common issues	254

Tips and tricks to connect 1000BASE-T

This section is going to help you set up applications more easily.



Data in this section

Data in this section was adapted from the corresponding section of the Alvim G5 User Guide. General information should be correct, but some values may not be suitable for Alvim G1.



Troubleshooting

This section is covering most issues to enable proper camera operation. Should you need more help, see [Troubleshooting common issues](#) on page 254.

Hardware selection

The selection of hardware components is a key factor to minimize the risk of dropped frames. This can be achieved by such as the recommended NICs to reduce the workload for the CPU or by real-time operating systems.

All components must support the link speed required to transfer and process the data output by the camera. Otherwise, the link speed of the camera must be configured accordingly. If a part of the link on the path is under heavy load, a QoS (quality of service) can be used to ensure the needed throughput.

Intel I219LM chipset

Laptops, NICs, or Ethernet adapters using **Intel I219-LM** chipset may cause problems when Alvim G1 is connected directly. The link may not be activated or only runs at reduced bandwidth. The general functionality of the camera might also be limited. As a workaround, connect the camera to a different network adapter.



Recommended products

Recommendations for products are based on tests and positive experience. We plan to extend these recommendations in future.

SFP adapters

Inexpensive RJ45 / xBASE-T SFP+ modules can be used to integrate cameras in fast (Q)SFP+ or (Q)SFP28 equipment. Please check that SFP+ modules support 1000BASE-T.

NIC hardware installation

Connect NICs directly to PCIe lanes of the CPU. If the NIC is connected to the chipset, ensure that the bandwidth between chipset and CPU is sufficient. Example: A NIC and an NVME SSD connected to the chipset, can create a bottleneck between chipset and CPU.

NIC firmware and drivers

Consider updating the firmware of the NIC, if available. Use newest drivers available.

NIC driver settings



Switches

You must apply the same settings to switches as to NICs.



1000BASE-T mode

The 1000BASE-T mode must be enabled on some NICs and SFP modules.

In systems with more than one NUMA (non-uniform memory access) node, the interconnect between the nodes can become a bottleneck. We recommend you to optimize the settings as suggested by the CPU and NIC manufacturer. If possible, lock the host software to the NUMA node connected to the NIC.

NIC driver settings under Linux



Receive buffer size

You can increase the receive buffer size to handle the data throughput

- Temporarily: `sysctl -w net.core.rmem_max=33554432`
- Permanently: Add to the file `/etc/sysctl.conf`:
`net.core.rmem_max=33554432`

The following commands can be used to find suitable settings. Note that these settings are **only temporary**. Adjust the corresponding system configuration files to change the settings permanently.

- Enabling Jumbo frames by setting the MTU size:
`ifconfig <dev> mtu 9000`
- Setting the IP address:
`ip a a 169.254.240.4/16 dev <dev>`

- Some 1000BASE-T NICs do not support auto negotiation.
Setting the link speed manually:
`ethtool -s <dev> autoneg off speed 1000`
- Enabling **Ethernet Flow Control**:
`ethtool -A <dev> tx on rx on`
`ethtool -A <dev> autoneg on`
`ethtool -r <dev>`

NIC driver settings under Windows

- Maximize the Jumbo frame size.
- Maximize the number of receive buffers.
- Switch off all non-required drivers, including filter drivers, in the network adapter settings. Mostly, the Vimba X filter driver helps to increase the performance. Be aware that using a PCAP filter, such as **Wireshark**, has an impact on the performance.
- Optimize settings related to IRQs (interrupt requests) in the network driver settings (interrupt moderation).
- RSS (receive side scaling) should be enabled to improve the performance when multiple cameras or several network adapters are connected to the host.
- Enable **Ethernet Flow Control** for Rx and Tx traffic.

Operation system settings

Settings under Linux

Be aware of automated network configuration tools. If configured incorrectly, these tools can periodically remove the network settings and try to find a connection to the Internet. Use a static configuration and deactivate these tools to avoid issues.

Settings under Windows

- Disable any power-management that might impact the performance, especially on NICs, PCIe or the CPU.
 - Activate **Ultimate Performance** for power plan.
 - Disable sleep modes that turn off the screen.
- Avoid unnecessary CPU and network load, also on different network adapters where no camera is connected.
- Disable antivirus software if possible.
- Avoid system events causing lost packets, such as by plugging in USB devices.

Vimba X TL settings

Configuring the **Vimba X** TL (transport layer) settings, can help to reduce dropped frames significantly. Look out for GenICam feature names starting with GVSP. Because every system is specific, individual experiments must be done.

This is an overview of GigE TL streaming features.



Transport layer descriptions and firmware downloads

Alvium Features Reference: www.alliedvision.com/en/support/technical-documentation/alvium-gige-documentation

Firmware downloads: www.alliedvision.com/en/support/firmware-downloads.

GVSPDriverSelector

GVSPDriverSelector controls which software component is used to handle the streaming.

- **Windows:** Either the stream engine of the transport layer or the filter driver is used to receive and process the GVSP packets.
- **Linux:** Only the transport layer can be used.
- **Values:**
 - *Socket*: Use of the transport layers stream engine
 - *Filter*: Use of the filter drivers stream engine

Figure 95 gives an overview of the different stream handling methods.

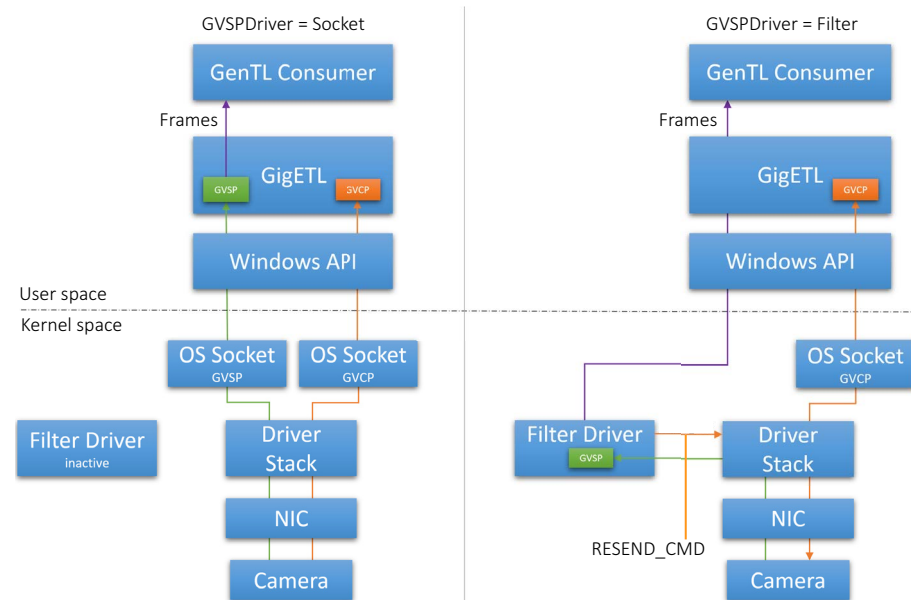

Figure 95: Stream handling with GVSPDriverSelector set to Socket or Filter

The filter driver minimizes the risk of lost frames substantially because it reduces the interactions between the user space and the kernel space, taking workload off the system:

When `GVSPDriver` is set to `Socket`, GVSP packets are processed in the user space. The downside of this approach: For each packet, system calls from the user space are required to enable GVSP packets pass from the kernel space.

Switching and transferring data between the kernel space and the user space is a time consuming process. This limits the number of GVSP packets a system can handle per second. Ensure the camera does not exceed this limit.

When `GVSPDriver` is set to `Filter`, the GVSP packets are processed by the filter driver that runs in the kernel space. This removes the linear dependency between system calls and GVSP packets. The filter driver copies the complete frame into the user space, coupling the number of system calls to the frame rate. Since the frame rate is substantially lower than the packet rate, the system has more resources left to handle the GVSP packets.

We recommend using the filter driver instead of the socket driver to increase performance and reliability.

If you cannot use the filter driver, you can reduce the number of GVSP packets per second. Increasing `GVSPPacketSize` is the only option to achieve this without reducing the performance of the camera.

GVSPPacketSize

`GVSPPacketSize` configures the total size of a GVSP packet, including the IP-, UDP- and GVSP headers.

The performance of the stream processing is largely determined by the number of received packets. [Figure 96](#) shows how `GVSPPacketSize` affects the CPU load during streaming at different packet sizes for the socket driver and the filter driver.

The diagram shows the total CPU load over all cores; on single cores, the difference between socket and driver is much larger. Values on your system may vary from values measured on our test system, but the relation is the same.

The packet size is inversely proportional to the number of packets per second. [Figure 96](#) shows that increasing the packet size reduces the number of packets, minimizing the risk of lost frames.

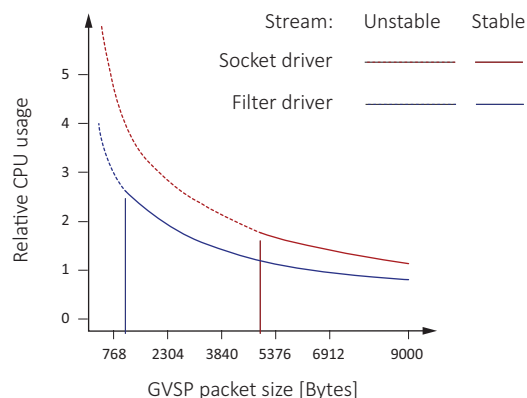

Figure 96: GVSPPacketSize versus CPU usage while the camera is streaming

Note: We recommend allowing the maximum packet size possible. To determine the maximum packet size supported by your system, the **Vimba X** API includes an automatic detection: Executing the **GVSPAdjustPacketSize** command first negotiates with the camera for the best possible packet size, then automatically sets **GVSPPacketSize**.

If the detected size is 1500 Bytes or less, ensure that Jumbo Frames are enabled on the host. Jumbo Frames must be enabled on all active Ethernet components.

GVSPBurstSize

GVSPBurstSize configures the number of GVSP packets that are processed at once before further checks, like missing packet detection, are executed.

Note: Currently the stream performance is not significantly affected. We recommend using the default value of **1**.

GVSPHostReceiveBufferSize

GVSPHostReceiveBufferSize controls the socket buffer space used to receive GVSP packets. The operating system adjusts the socket buffer continuously. The value may be limited internally by the operating system. See the **SO_RCVBUF** documentation of the operating system.

Note: This feature cannot be used with the filter driver.

GVSPTimeout

GVSPTimeout is used to react on a possible streaming interruption. If no GVSP packet is received during the last **GVSPTimeout** milliseconds, the stream engine forces a resend of currently missing GVSP packets.



Dropped frames with certain ROIs

With certain ROIs, dropped frames may occur. This can mostly be avoided when **GVSPTimeout** is set to $1/\text{frame rate}$.

GVSPtiltingSize

GVSPtiltingSize is used to cancel the reception of a single frame if a certain number of GVSP packets of the following frame has already been received.

The frame is marked as incomplete and returned to the GenTL consumer.

GVSPMaxRequests

GVSPMaxRequests is used to configure the maximum amount of **RESEND_COMMANDS** requested for a missing GVSP packet. Setting the feature to **0** disables the GigE Vision resend mechanism. The transport layer or filter driver does not request the re-transmission of any missing GVSP packet.

GVSPMissingSize

`GVSPMissingSize` is used to cancel the reception of a single frame if the resend limit `GVSPMaxRequests` is reached for too many packets.

The frame is marked as incomplete and returned to the GenTL consumer.

Configuring the resend behavior

`GVSPMaxLookBack` and `GVSPMaxWaitSize` can be used to configure the "timing" of `RESEND_CMDs`.

GVSPMaxLookBack

`GVSPMaxLookBack` can be used to delay the first `RESEND_CMD` for a missing GVSP packet by X packets.

GVSPMaxWaitSize

`GVSPMaxWaitSize` can be used to delay the `RESEND_CMD` for the same missing GVSP packet. The transport layer or the filter driver waits until `GVSPMaxWaitSize` of packets has been reached before requesting a resend for the same packet again.



`GVSPMaxLookBack = 1 | GVSPMaxWaitSize = 2 | GVSPMaxRequests = 2`

Figure 97: Controlling the resend of packets (example)

Optimizing performance

Image transfer with rolling shutter cameras

Alvium G1-500m/c, G1-1240, and G1-2050m/c

If acquisition is started and stopped in a short sequence, no image is transferred to the host. The duration cannot be predicted, because it depends on various factors.

Parameter changes

Alvium G1-500m/c, G1-1240, and G1-2050m/c

If parameters are changed while these cameras are streaming, the following effects can occur.

Stopped streaming

When `AcquisitionMode` set to `MultiFrame`: If cameras are triggered by `AcquisitionStart`, the streaming stops when parameters are changed.

For `MultiFrame` acquisition, we recommend to you stop streaming before you change parameters.

Frame rate jitter

Generally, some parameters can be changed during exposure without affecting the timing. For models with ON Semiconductor AR sensors and rolling shutter sensors, a different behavior must be considered for **camera operation in freerun mode without triggering**:

Changing parameters during exposure leads to frame rate jitter. When parameters are entered, the next frame starts only after readout and sensor reconfiguration delay are finished. When the camera is run in `ExposureAuto` mode, the actual frame rate is less than the calculated value for the corresponding exposure time. Consider frame rate jitter for your application, including a gap between `ExposureActive` signals.

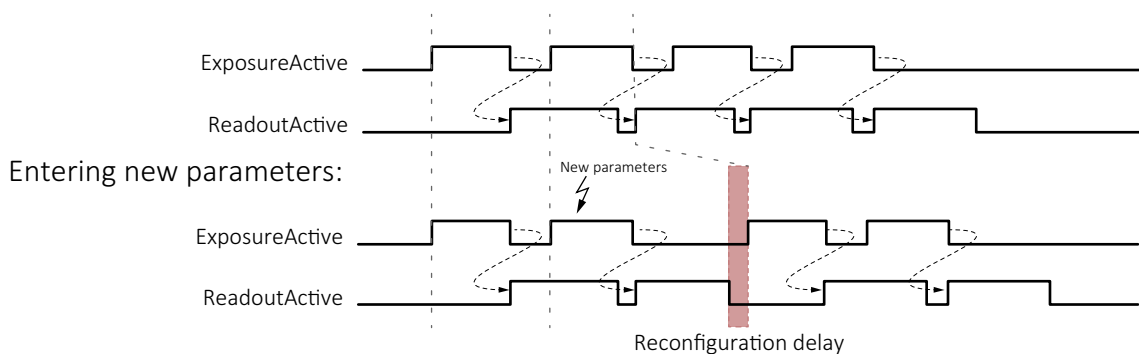

Figure 98: Delayed exposure due to parameter changes



Parameter changes in triggered mode

See [Ignored triggers](#) on page 228 for more information.

Value changes by feature interdependencies

The conversion between time and clock cycles affects control values. Features for pixel format, bandwidth, ROI, exposure time, and triggering are related to each other. Changing values for one feature can change values for another feature. For example, frame rates can be reduced when `PixelFormat` is changed subsequently. [Figure 99](#) shows the interdependencies.

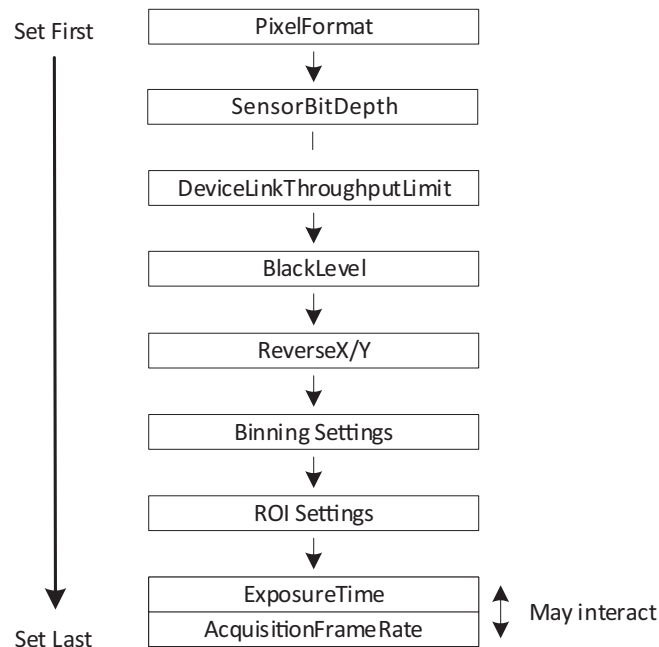

Figure 99: Interdependencies between features

Effects for the interdependent features

Changing one control's value affects other control's values, such as:

If: `Height` value is changed.

Then: Other values may be affected, such as for `AcquisitionFrameRate` and `ExposureTime`.

We recommend you to consider:

- The more features you adjust, the more current values deviate from previously set values.
- The same effects that apply to `ExposureTime`, also apply to `AutoExposure`.
- To avoid readjustments, apply settings in the order shown in [Figure 99](#).

Impact by other features

Input	Output	
	Exposure time values	Frame rate
AcquisitionFrameRate	Not affected	Affected
ExposureTime	Affected as expected	Affected
DeviceLinkThroughputLimit	Affected	Affected
Height	Not affected	Affected
Width	May be affected	May be affected

Table 122: Impact by other features

Exposure times and frame rates with Sony IMX rolling shutter cameras

Alvium G1-1240m/c, G1-2050m/c

Generally, long exposure times result in low frame rates because one is roughly the inverse of the other. For Alvium G1 cameras with Sony IMX RS sensors:

- The range of available frame rates depends on the exposure time.
- The exposure time must be increased when low frame rates are used.
- The available range for frame rate values depends on the exposure time. If by changing the exposure time, the previous frame rate is moved out of the available range, the frame rate is adjusted automatically.

Dark current compensation

All sensors accumulate dark current in the pixels. Dark current increases the signal level and black level. Most sensors in Alvium G1 cameras compensate for this.

If cameras are operated at high temperatures or long exposure times, compensation reaches its limits. The typical compensation mechanism uses a **margin** to compensate for dark current. This works only until dark current reaches the size of the margin. The following table shows the relation of the margin and accumulated dark current for a pixel in 8-bit mode with a maximum value of 255.

Effective signal versus noise	Description
	The pixel has accumulated no dark current, the margin has maximum size.
	The pixel has accumulated some dark current, reducing the size of the margin.
The following images show a pixel that has accumulated a higher dark current than the margin.	
	The pixel has accumulated dark current, the margin reduces to 0. <ul style="list-style-type: none"> • Dark current compensation stays active. • Maximum saturation signal decreases. • Fixed pattern noise increases. This sensor-internal compensation is typically used in the analog domain.

Table 123: Accumulated dark current affecting the effective image signal

Additional compensation

If compensation limits are reached and you cannot decrease operating temperature or exposure time, what can you do to keep signal quality high?

You can increase the margin size by using gain, with the following side effects:

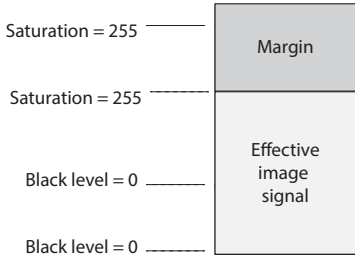
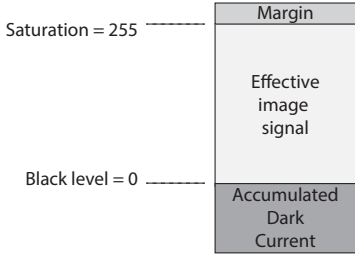
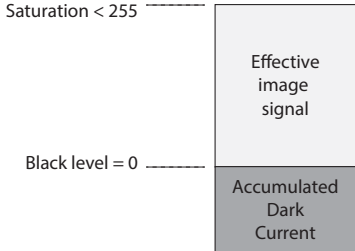
- To give space to a larger margin, the effective pixel capacity decreases.
- White and light gray values are shifted down to gray.

Shutter types affecting image readout

Most Alvium G1 camera models are operated using global shutter (GS):

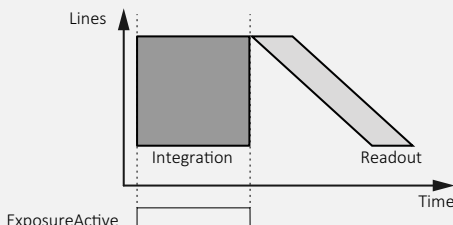
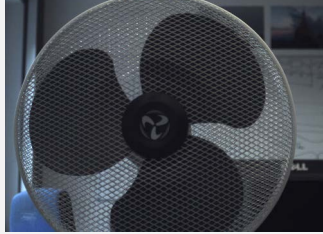
Property	Line readout	Moving image
Global shutter (GS)		

Alvium G1-500 models use rolling shutter (RS). Alvium G1-1240 and G1-2050 models offer global reset shutter (GRS) in addition:



Property	Rolling shutter (RS)	Global reset shutter (GRS)
Line readout		
Line exposure start	Deferred from line to line	Common for all lines
Line exposure time	Common for all lines	Increases from line to line
Image acquisition of moving objects		
Image brightness	Constant over the image	Varying over the image
Moving objects	Distorted shape	Shape without distortion
Typical application	Static objects	Moving objects
Compensation	Use an additional mechanical shutter or use a strobe light:	
		

Table 124: Shutter types affecting image readout

DevicePowerSavingMode

If you want to pause camera operation, you can use `DevicePowerSavingMode` to reduce the power consumption of Alvim G1 cameras.

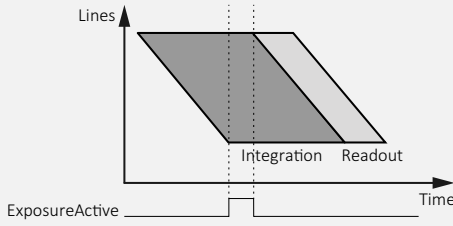
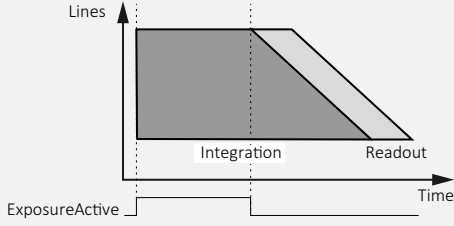
You can select between standard power use and *StandbyMode*:

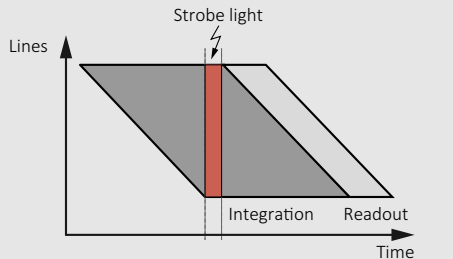
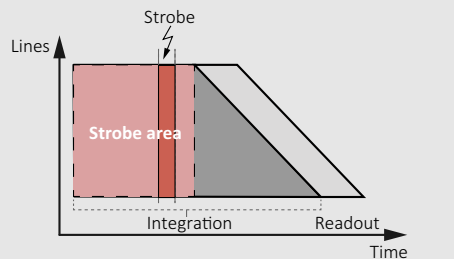
Values	Description
<i>Disabled</i>	The camera uses standard power (default).
<i>StandbyMode</i>	Camera functions are disabled to reduce power consumption. However, the control channel is maintained active: The camera can still be controlled by GenICam features.

Table 125: Options for `DevicePowerSavingMode`



Returning to standard power mode

Use `DeviceReset` command to switch from *StandbyMode* back to *Disabled*.

Operating systems and bandwidth

If the camera data output exceeds the bandwidth supported by the host computer, images may be corrupted. This section gives some background information to enable proper image transfer.

Sensor data output and camera data output

Typically, the required bandwidth for image acquisition can be estimated for a given frame rate, pixel format, and resolution by over-the-thumb calculations.

Figure 100 shows the bandwidth for a higher (1) and a lower (2) value for `DeviceLinkThroughputLimit` with Alvim G1.

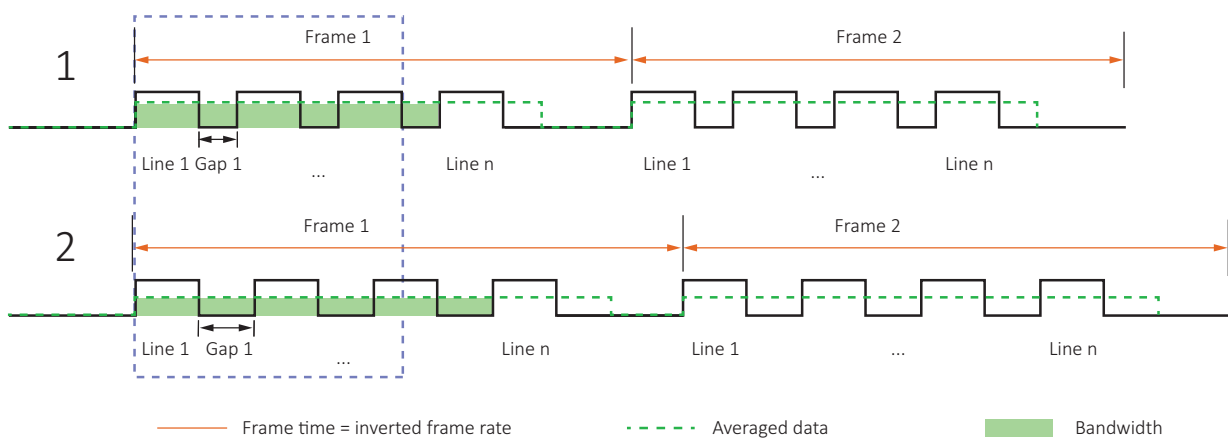

Figure 100: Sensor data output and camera data output

- Generally, data rate is averaged over the frame time.
- When high-resolution Alvium G1 cameras are operated at higher frame rates, corrupted frames can occur. This is shown schematically in [Figure 100](#).
- Using **DeviceLinkThroughputLimit**: Reduces the maximum line data rate.

DeviceLinkThroughputLimit controls the maximum bandwidth of the data streamed out by the camera. When the value for this feature is reduced, the gaps between the lines are increased. This reduces the frame rate and therefore the bandwidth.

Additionally, you may reduce the frame rate to reduce bandwidth.

Consider that **Vimba X Viewer** does not gray out values that exceed the bandwidth supported by the host computer.



Feature description for **DeviceLinkThroughputLimit**

For a description of this feature, see the Alvium Features Reference: www.alliedvision.com/en/support/technical-documentation/alvium-gige-documentation.

Hardware and bandwidth

For a smooth data transfer of Alvium G1 cameras, the host computer must be equipped with a high-bandwidth 1000BASE-T compliant NIC. We recommend using direct point-to-point links from camera to NIC for best performance.

Vimba X settings

During freerun, Alvium G1 cameras do not automatically adapt the frame rate to the limits of your system, including the NIC. If the data rate is too high, it receives corrupted frames. The image transfer status in **Vimba X Viewer** is signaled as **Running**. However, the corrupted frames are not displayed. For a solution, see [Camera cannot acquire images](#) on page 255.

Reference system

We have tested available frame rates on a desktop PC. Cameras were operated in `AquisitionMode = Continuous`, frame rates were measured using **Raspberry Pi** and **pigpio library**.



More information on pigpio library

For more information on pigpio library, see <https://abyz.me.uk/rpi/pigpio/index.html>.

Stated values were measured for bandwidths of 122 MByte/s and 12 MByte/s for [Operation for maximum frame rates](#), using the following test setup:

Component	Property
Operating system	Windows 10 Pro Version 1903, Build 18362. 1256
Work station	Dell Precision T5610
System type	x64-based PC
CPU	Intel(R) Xeon(R) CPU E5-2620 v2 @ 2.10GHz, 2095 Mhz, 6 Cores, 12 logical processors
BIOS	Dell Inc. A07, 4/29/2014
SM BIOS Version	V2.7
RAM	16 GB DDR3 DIMM (2 x 8 GB), 1600 MHz
Total virtual memory	18.3 GB
Page file space	2.38 GB
Kernel DMA Protection	Off
Virtualization-based security	Not enabled
Hype-V enabled for	<ul style="list-style-type: none"> • VM Monitor Mode Extensions • Second Level Address Translation Extensions • Virtualization Enabled in Firmware • Data Execution Protection
Graphics controller	NVIDIA NVS 310, driver 10.18.13.5362, 512 MB DDR3 PCI-Express
Hard discs 1,2 (RAID 1 system)	Seagate Desktop HDD S-ATA 7200 rpm, 1 TB, firmware CC45
NIC	Marvel FastLinQ Edge 10Gbit Network Adapter
NIC firmware	V3.0.18.0
Ethernet driver	Marvel Semiconductor Inc. 3.0.18.0

Table 126: Test setup components

Feature values

Source	Feature	Value	Comments
Camera	DeviceLinkThroughputLimitMode	<i>On</i>	Not applicable
	DeviceLinkThroughputLimit	115MByte/s ¹	1000BASE-T NICs
Transport layer	GVSPDriverSelector	<i>Filter</i>	Windows only
	GVSPPacketSize	16334	Vimba X default
	GVSPBurstSize	1	
	GVSPHostReceiveBufferSize	Not applicable	See footnote ²
	GVSPMaxLookBack	30	Vimba X default
	GVSPMaxWaitSize	100	
	GVSPMissingSize	256	
	GVSPTiltingSize	100	
GVSPTimeout	70		

¹ This value enables the host to request resent packets and sent command packets.

² This feature is disabled when *GVSPDriverSelector* is set to *Filter*.

Table 127: Feature values



Description for camera and transport layer features

See the Alvium Features Reference: www.alliedvision.com/en/support/technical-documentation/alvium-gige-documentation.

Troubleshooting common issues

Camera is not powered

Camera or system issue?

When the camera is connected, the [Status LEDs](#) signal the camera status. If the LEDs of a connected camera are not illuminated, check with a working camera.

Power supply

If using a custom power supply, ensure that

- The adapter and wire gauge are rated 1 A at 12 VDC (lower current for higher voltages).
- The TFM connector is supplied with minimum 10.8 VDC despite voltage drop across the cabling.

Camera is not detected in the viewer

The camera is powered correctly, but it is not detected in the viewer.

Ethernet cabling

Damaged or poor quality Ethernet cabling can result in no cameras found, dropped packets, decreased bandwidth, and other problems. Use Category 6 or higher rated Ethernet cabling.

NICs and NIC ports

Laptops, NICs, or Ethernet adapters using **Intel I219-LM** chipset may cause problems when Alvium G1 is connected directly. The link may not be activated or only runs at reduced bandwidth. The general functionality of the camera might also be limited. As a workaround, connect the camera to a different network adapter.

Ethernet adapter settings

Return to [IP settings](#) on page 209, which describes how to adjust the IP address of the host adapter. Do not use gateways on your NIC. Connect a single camera directly to your NIC.

Ensure that IP address of the adapter is on the same subnet as the camera. If not, return the adapter address to the Auto IP configuration. A sample IP configuration for the camera and adapter is shown below.

	Adapter	Camera
IP address	169.254.23.2	169.254.43.3
Subnet mask	255.255.0.0	255.255.0.0

Table 128: Sample IP configuration

Camera cannot acquire images

The camera is detected in the viewer but does not acquire images.

Revert the camera settings to factory default: In the controller window of **Vimba X Viewer**, under `SavedUserSets`, set `UserSetDefaultSelector = Default`, click `UserSetLoad`, and click the `Execute` button.

If StatFramesDelivered / StatPacketsReceived = 0

- Click on `Stream > Statistics` to view camera freerun statistics.
- Disable your firewall on Ethernet adapter connected to camera to avoid blocking incoming traffic.
- Ensure that in **Vimba X Viewer**:
`AcquisitionFrameRateEnable = True`
`TriggerSelector = FrameStart`
`TriggerSource = Software` or `LineX`
- Consider that some trigger modes require a trigger event to capture frames.

If StatFramesDropped ≠ 0

Packets are incoming, but all dropping.

Enable Jumbo Frames on your adapter, see [Adjusting the NIC driver settings](#) on page 210.

If StatFramesDelivered value increases, but images are black

- Ensure your scene is sufficiently lit.
- Increase the exposure time value, using `ExposureTimeAbs`.
- Ensure the lens is properly installed and the lens cap has been removed.



If you are still having problems, please contact support at www.alliedvision.com/en/about-us/contact-us/technical-support-repair-/-rma.

Packets are dropped

- Check the Ethernet cable. A damaged cable often causes the link to negotiate a lower speed as fallback.
- **Windows:** Disable auto updates and telemetry.
- Use the latest NIC driver from the NIC manufacturer.
- Enable Jumbo Frames/Packets on the NIC. Larger packets result in less overhead on the host CPU. See [Enabling Jumbo Packets](#) on page 210.



Available packet size

Be aware that the effective maximum packet size is limited to the biggest size supported by all network devices on the path.

- Enable Ethernet Flow Control on NICs and switches, see [NIC driver settings](#) on page 239.
- Disable the firewall if no filter driver is used.
- If possible, use a dedicated network infrastructure:
 - Ideally, each camera has a point-to-point connection to a dedicated network adapter in the host.
 - Separate camera networks from other networks.
 - Avoid aggregating multiple cameras over a single network link if possible. The more cameras use a common link, the lower becomes the usable total system throughput, caused by packet losses or less effective processing on the host side.
- **Linux only:** Run as root, allowing the OS to boost the priority of the Allied Vision driver thread, and the driver to bind directly to the NIC adapter. Users who feel running as root compromises their system security may find the following implementation satisfactory:
 - Set the executable owner as root.
 - Set the “setuid” permission bit on the executable.
 - In code, when application starts use `capset()` to release all but these privileges: `CAP_SYS_NICE`, `CAP_NET_ADMIN`, `CAP_NET_BROADCAST`, `CAP_NET_RAW`. The application will start with all root privileges, but it will drop them immediately after startup.

Index

A

AcquisitionActive	226
aligning Alvium G1 BL Frame	197
Alvium G1 BL	
camera mounting	196
dimensions and mass	159
hardware options	17
interface unit	17
overview	17
sensor unit	17
technical drawings	160
Alvium G1 BL Frame	
aligning	197
camera mounting	198
dimensions and mass	159
overview	18
sensor position accuracy	170
technical drawings	163
Alvium G1 BL No Mount	
camera mounting	199
general	189
serial numbers	190
Alvium G1 Closed Housing	
camera mounting	194
dimensions and mass	155
sensor position accuracy	169
technical drawings	155
Auto IP configuration	255

B

back panel	216
board level cameras	17

C

camera connectors	216
camera hardware	214
camera identification	
Model ID	42
serial numbers G1 BL	190
camera mounting	
G1 BL	196
G1 BL Frame	198
G1 BL interface unit	201
G1 BL No Mount	199
G1 Closed Housing	194

general	193
maximum torque	203
Category 6	211, 254
connectors	214
cooling areas	
G1 BL interface unit	201
G1 BL sensor unit	192
copyright	45
current and voltage	49

D

dark current compensation	248
DevicePowerSavingMode	250
digital binning	62
dimensions	155
dimensions and mass	
Alvium G1 BL	159
Alvium G1 BL Frame	159
Alvium G1 Closed Housing	155
document	
conventions	36
history	27
overview	15

E

ESD	48
-----------	----

F

FCC	43
feature availability	172
firmware update	232
Flow Control	
Linux	240
Windows	240

FPC cables

handling	202
frame rates > reference settings	59

G

general safety notes	45
GenICam	55
GigE Vision	55
global reset shutter (GRS)	249
global shutter (GS)	249

H

heat dissipation	46
all Alvium G1	191
G1 BL	192
heat sink mounting	191

host computer		
configuring	208	
connecting	213	
connecting 1000BASE-T	238	
Jumbo Packets	210	
NIC driver installation	208	
NIC driver settings	210	
NIC IP address	209	
I		
I/Os, GPIOs		
connector pin assignment	217	
description	218	
image data flow	229	
interfaces	214	
IP class	55	
IR cut filter	168	
J		
Jumbo Packets	210	
L		
lens		
focal length vs. FOV	175	
maximum protrusion	52, 167	
mounting	204	
mounts	167	
vignetting	176	
M		
mass	155	
MutipleRegions	63	
N		
NIC		
safety	50	
troubleshooting	254	
O		
operating temperature	65	
P		
power consumption > reference settings	65	
powering up the camera	212	
R		
readout modes	60	
reference system	252	
ROI frame rates	59	
rolling shutter (RS)	249	
S		
safety	2, 45	
camera power	49	
cooling areas	192, 201	
electrical connections	48	
heat dissipation	46, 191	
heavy lenses	48	
lens mounts	45	
lens protrusion	52	
mounting cameras	47	
NIC	50	
optical components	51	
sensor	51	
sensor ADC readout modes	60	
sensor binning	62	
sensor cleanliness (definition)	52	
sensor position accuracy	169	
shift + rotation - G1 BL Frame	170	
shift + rotation - G1 Closed Housing	169	
tilt - housed G1	170	
sensor shutter types	61	
shock and vibration	55	
specifications	54	
standards applied	55	
status LEDs	224	
streaming is stopped	245	
T		
technical drawings	155, 160	
Alvium G1 BL	160	
Alvium G1 BL Frame	163	
Alvium G1 Closed Housing	155	
trigger latency	226	
trigger signal flow	226	
triggering with RS cameras	227	
troubleshooting	237	
bandwidth	250	
dark current compensation	248	
dropped packets	256	
feature interdependencies	246	
frame rate jitter	245	
parameter changes	245	
streaming is stopped	245	
troubleshooting common issues	254	
U		
UART	218	
user sets	171	

V
vignetting 176

W
white balance default 154