



## USB3 VISION CAMERAS

# Alvium USB Cameras User Guide

V4.6.1

FW 00.13.01.794391f9

Note: Lenses are not part of this product.

**Quick links**

- [Alvium USB cameras at a glance](#) on page 15
- [Contact us](#) on page 21
- [Contents](#) on page 22

# Read before use

## EN - English

### Safety

Before using the camera, read these safety instructions. Observe the warnings at all times. Use the camera only as stated in the [Intended use](#) on page 53.

**CAUTION****Risk of burns**

A camera in operation can reach temperature levels which could cause burns.

**CAUTION****Injury by falling cameras or lenses**

A falling camera or lens can cause injury.

**CAUTION****Risk of cuts by sharp edges**

The product can have sharp edges.

### Intended use

Intended use of Allied Vision product is the integration into vision systems by professionals. All Allied Vision product is sold in a B2B setting.

### Cameras without closed housings

Cameras without housing or with incomplete housing must be shielded against EMC emission by professionals according to local EMC provisions.

## DA - Dansk

### Sikkerhed

Læs sikkerhedsanvisningerne, før kameraet bruges. Overhold alle advarsler. Brug kun kameraet som anført i [Intended use](#) på side 53.



#### FORSIGTIG

##### **Forbrændingsfare**

Når kameraet bruges, kan det blive meget varmt og forårsage forbrændinger.



#### FORSIGTIG

##### **Kvæstelser, hvis kameraet eller linser falder ned**

Falder kameraet eller linsen ned, kan dette forårsage kvæstelser.



#### FORSIGTIG

##### **Fare for skarpe kanter**

Produktet kan have skarpe kanter.

### Tilsluttet brug

Allied Vision produktets tilsluttede brug er en indbygning i et visionssystem, udført af fagfolk. Alle Allied Vision produkter sælges i B2B.

### Kameraer uden lukket hus

Kameraer uden hus eller uden komplet hus skal beskyttes mod EMC emissioner iht. lokale EMC bestemmelser.

## DE - Deutsch

### Sicherheit

Bevor Sie die Kamera benutzen, lesen Sie diese Sicherheitshinweise. Beachten Sie diese Hinweise immer. Verwenden Sie die Kamera nur wie beschrieben in [Intended use](#) auf Seite 53.



#### VORSICHT

##### **Gefahr von Verbrennungen**

Im Betrieb kann die Kamera Temperaturen erreichen, die zu Verbrennungen führen.



#### VORSICHT

##### **Verletzung durch fallende Kameras oder Objektive**

Eine fallende Kamera oder ein fallendes Objektiv kann Verletzungen verursachen.



#### VORSICHT

##### **Schnitte durch scharfe Kanten**

Das Produkt kann scharfe Kanten haben.

### Bestimmungsgemäßer Gebrauch

Allied Vision Produkte sind bestimmt für die Integration in Bildverarbeitungssysteme durch Fachpersonal. Alle Allied Vision Produkte werden in einer B2B-Umgebung verkauft.

### Kameras ohne geschlossenes Gehäuse

Für Kameras ohne Gehäuse oder mit unvollständigem Gehäuse muss die Abschirmung gegen EMV-Emissionen gemäß den örtlichen EMV-Bestimmungen durchgeführt werden.

## ES - Español

### Seguridad

Antes de utilizar la cámara lea estas instrucciones de seguridad. Observe las advertencias en todo momento. Utilice la cámara solo tal y como se estipula en el [Intended use](#) en la página 53.



#### ATENCIÓN

##### Riesgo de quemaduras

Una cámara en funcionamiento puede alcanzar temperaturas que podrían provocar quemaduras.



#### ATENCIÓN

##### Lesiones en caso de que las cámaras o las lentes se caigan

Si una cámara o una lente se cae puede provocar lesiones.



#### ATENCIÓN

##### Riesgo de cortes por bordes afilados

El producto puede tener bordes afilados.

### Uso previsto

El uso previsto del producto Allied Vision es la integración en el sistema de visión por parte de profesionales. Todos los productos Allied Vision se venden dentro de una relación B2B.

### Cámaras sin carcasa cerrada

Las cámaras sin carcasa o con una carcasa incompleta deben protegerse contra las emisiones CEM por parte de profesionales de acuerdo con las disposiciones locales sobre la CEM.

## FI - Suomi

### Turvallisuus

Lue nämä turvallisuusohjeet ennen kameran käyttöä. Noudata varoituksia joka hetki. Käytä kameraa ainoastaan kohdassa [Intended use](#) sivulla 53 kuvatulla tavalla.



#### HUOMIO

##### Palovammojen vaara

Käytössä olevan kameran saavuttamat lämpötilatasot voivat aiheuttaa palovammoja.



#### HUOMIO

##### Putoavien kameroiden tai linssien aiheuttamat vammat

Putoava kamera tai linssi voi aiheuttaa vammoja.



#### HUOMIO

##### Terävien reunojen aiheuttama viiltovaara

Tuotteessa voi olla teräviä reunoja.

### Käyttötarkoitus

Allied Vision-tuotteen käyttötarkoitus on integrointi kuvajärjestelmiin ammattilaisten toimesta. Kaikki Allied Vision-tuotteet myydään B2B-ympäristössä.

### Kamerat, joissa ei ole suljettuja koteloita

Ammattilaisten on suojattava kamerat, joissa ei ole koteloa tai joiden kotelo on epätäydellinen, EMC-päästöiltä paikallisten EMC-määräysten mukaisesti.

## FR - Français

### Sécurité

Veillez lire ces consignes de sécurité avant d'utiliser la caméra. Respectez continuellement les avertissements. Utilisez la caméra uniquement comme indiqué sous [Intended use](#), page 53.



#### ATTENTION

##### Risque de brûlures

Une caméra en service peut atteindre des niveaux de température susceptibles d'entraîner des brûlures.



#### ATTENTION

##### Blessures en cas de chute de caméras ou d'objectifs

La chute d'une caméra ou d'un objectif peut entraîner des blessures.



#### ATTENTION

##### Risque de coupures sur des bords tranchants

Le produit peut présenter des bords tranchants.

### Utilisation prévue

L'utilisation prévue du produit Allied Vision est son intégration dans des systèmes de vision par le soin de professionnels. Tout produit Allied Vision est vendu dans un cadre B2B.

### Caméras sans boîtier fermé

Les caméras sans boîtier fermé ou à boîtier incomplet doivent être blindées contre les émissions CEM par le soin de professionnels conformément aux dispositions CEM locales.

## עברית - HE

### בטיחות

לפני השימוש במצלמה, עליך לקרוא את הוראות הביטחון האלו. עליך לממש הוראות ביטחון אלו תמיד. השימוש במצלמה הוא רק לפי מה שכתוב ב"כוונת השימוש" (Intended use) בעמוד 53.

#### זהירות

##### סכנת כוויה

בזמן הפערת המצלמה עלולות טמפרטורות גבוהות לעלות, שיכולות לגרום לכוויות.



#### זהירות

##### פגיעה מנפילת מצלמות או עדשות

מצלמה או עדשה שנופלות עלולות לגרום לפגיעה.



#### זהירות

##### סכנת חתכים על ידי קצוות חדים

למוצר יכולים להיות קצוות חדים.



### שימוש מיועד

מוצרי AlliedVision מיועדים לשילוב במערכות ממוחשבת לעיבוד צילומים ע"י אנשי מקצוע. כל מוצרי AlliedVision נמכרים לשימוש בסביבת B2B.

### מצלמות ללא מארז סגור

מצלמות ללא מארז, או עם מארז חלקי בלבד, חייבות להיות מוגנות בפני קרינה אלקטרומגנטית (EMC) על ידי אנשי מקצוע בהתאם לתקנים המקומיים (EMC).



## IT - Italiano

### Sicurezza

Leggere queste istruzioni per la sicurezza prima di utilizzare la telecamera. Osservare sempre tutte le avvertenze. Utilizzare la telecamera come descritto alla sezione [Intended use](#) a pagina 53.



#### ATTENZIONE

##### **Pericolo di ustioni**

Durante il funzionamento una telecamera può raggiungere temperature elevate che possono essere causa di ustioni.



#### ATTENZIONE

##### **Lesioni dovute alla caduta di telecamere o lenti**

La caduta di una telecamera o di una lente può causare delle lesioni.



#### ATTENZIONE

##### **Pericolo di tagliarsi sui bordi affilati**

I bordi del prodotto lente possono essere affilati.

### Uso previsto

Il prodotto Allied Vision è concepito per essere integrato in sistemi di monitoraggio in campo professionale. Tutti i prodotti Allied Vision sono venduti in uno scenario B2B.

### Telecamere senza custodia chiusa

Le telecamere senza custodia o con una custodia incompleta devono essere protette dalle emissioni elettromagnetiche in ambienti professionali in conformità con le norme CEM nazionali.

## JA - 日本語

### 安全性

本カメラを使用する前に、この安全の手引きをお読みください。常に、警告事項を守ってください。必ず、[Intended use 53](#) ページの通りに、本カメラを使用してください。



#### 注意

やけどの危険性

作動中のカメラは、やけどを引き起こす温度まで熱くなる恐れがあります。



#### 注意

カメラまたはレンズの落下によるけが

カメラまたはレンズが落下すると、けがをする恐れがあります。



#### 注意

な端部で切り傷の危険性

本製品には鋭利な部分がある場合があります。

### 用途

Allied Vision製品は、専門家が視覚装置に統合することを意図したものです。すべてのAllied Vision製品は、企業間取り引き用に販売されています。

### ハウジングで閉じられていないカメラ

ハウジングのないカメラまたはハウジングが不完全なカメラは、現地の電磁両立性（EMC）規定に従い、専門家によって、EMCエミッションから保護される必要があります。

## NL - Nederlands

### Veiligheid

Lees deze veiligheidsinstructies voordat u de camera gaat gebruiken. Neem deze waarschuwingen altijd in acht. Gebruik de camera uitsluitend, zoals aangegeven in het [Intended use](#) op pagina 53.



#### VOORZICHTIG

##### Risico van verbranding

Een camera die gebruikt wordt, kan temperatuurwaarden bereiken die brandwonden kunnen veroorzaken.



#### VOORZICHTIG

##### Letsel door vallende camera's of lenzen

Een vallende camera of lens kan letsel veroorzaken.



#### VOORZICHTIG

##### Risico van snijwonden door scherpe randen

Het product kan scherpe randen hebben.

### Beoogd gebruik

Het beoogde gebruik van het Allied Vision-product is de integratie in optische systemen door professionals. Alle Allied Vision-producten worden verkocht in de B2B-markt.

### Camera's zonder gesloten behuizing

Camera's zonder behuizing of met een onvolledige behuizing moeten door professionals worden beschermd tegen EMC-straling door EMC-beschermingen ter plaatse.

## NO - Norsk

### Sikkerhet

Les disse sikkerhetsinstruksene før du bruker kameraet. Følg advarslene til en hver tid. Bruk kun kameraet i samsvar med [Intended use](#) på side 53.



#### FORSIKTIG

##### Risiko for brannskader

Et kamera i bruk kan nå temperaturnivåer som kan forårsake brannskader.



#### FORSIKTIG

##### Skade ved fallende kameraer eller linser

Et fallende kamera eller en fallende linse kan forårsake skade.



#### FORSIKTIG

##### Risiko for kutt fra skarpe kanter

Produktet kan ha skarpe kanter.

### Tiltenkt bruk

Den tiltenkte bruken av Allied Vision-produktet er integrering i visjonssystemer av profesjonelle. Alle Allied Vision-produkter selges i en forretning til forretning-situasjon.

### Kameraer uten lukkede kamerahus

Kameraer uten kamerahus eller med ufullstendige kamerahus må beskyttes mot EMC-utslipp av fagfolk i henhold til lokale EMC-bestemmelser.

## SV - Svenska

### Säkerhet

Läs igenom säkerhetsinstruktionerna innan du använder kameran. Var hela tiden särskilt uppmärksam på varningarna. Använd enbart kameran på det sätt som anges i [Intended use](#) på sida 53.



#### **VARNING**

##### **Risk för brännskada**

En kamera i drift kan komma upp i temperaturer som kan orsaka brännskador.



#### **VARNING**

##### **Risk för skador från fallande kameror eller objektiv**

Fallande kameror eller objektiv kan förorsaka skador.



#### **VARNING**

##### **Risk för skärsår från vassa kanter**

Produkten kan ha vassa kanter.

### Avsedd användning

Den avsedda användningen av Allied Vision-produkter är integrering i visionssystem av fackmän. Samtliga Allied Vision-produkter säljs i en B2B-miljö.

### Kameror utan slutna kamerahus

Kameror utan eller med ofullständiga kamerahus måste skyddas mot elektromagnetiska emissioner av fackmän enligt lokala bestämmelser för elektromagnetiska emissioner.

## ZH – 简体中文版

### 安全需知

使用本相机前，请阅读本安全说明书。请务必遵守相关警告 和 [Intended use](#) 于第 53 页。



#### 注意事项

##### 烫伤风险

相机操作过程中温度可能上升并导致烫伤风险。



#### 注意事项

##### 相机或者镜头跌落造成伤害

相机或者镜头可能会跌落并造成伤害。



#### 注意事项

##### 锋利边缘割伤的风险

产品可能有锋利的边缘。

### 预期用途

Allied Vision 产品的预期用途是由专业人士整合到视觉系统中。所有 Allied Vision 的产品均通过 B2B 渠道销售。

### 无封闭式外壳相机

使用不带外壳或外壳不完整的相机时，必须由专业人员根据当地的 EMC 规定，对其进行 EMC 屏蔽。

# Alvium USB cameras at a glance



Get an overview of Alvium USB camera documentation:

Consider for Alvium USB cameras .....	16
Shipping contents.....	16
What else do you need? .....	16
Alvium Flex- more flexibility .....	17
Alvium Frame- use your own optical mount .....	19
Alvium Pol- using polarization (coming soon) .....	20

## Consider for Alvium USB cameras

Please read the following to better understand your Alvium USB camera and to setup your application smoothly:

- [Exposure time and frame rates](#) on page 67
- Alvium USB properties: [Performance and troubleshooting](#) on page 299
- [User sets](#) on page 235, including supported features and trigger features
- Reducing the power consumption: [Using the U3 mode](#) on page 309
- [Bare board cameras](#) on page 257

## Shipping contents

- Alvium USB camera
- Download Instructions for First Camera Operation document

## What else do you need?

This is a selection of helpful downloads:

Download	Link
Alvium Cameras Features Reference	<a href="http://www.alliedvision.com/en/support/technical-documentation/alvium-usb-documentation">www.alliedvision.com/en/support/technical-documentation/alvium-usb-documentation</a>
Application notes	
<b>Alvium Modular Concept</b> for extended hardware options, such as Alvium Frame or Flex.	
<b>Vimba X SDK</b> for Windows, Linux, and Linux/ARM, including <b>Vimba X Viewer</b> , <b>Firmware Updater</b> , and <b>Driver Installer</b> for Windows	<a href="http://www.alliedvision.com/en/products/software/vimba-x-sdk">www.alliedvision.com/en/products/software/vimba-x-sdk</a>
Firmware downloads	<a href="http://www.alliedvision.com/en/support/firmware-downloads">www.alliedvision.com/en/support/firmware-downloads</a>
<b>STEP files</b>	Downloads for standard Alvium USB models: <a href="http://www.alliedvision.com/en/camera-selector">www.alliedvision.com/en/camera-selector</a>  Downloads for Alvium Flex or Frame: <a href="http://www.alliedvision.com/en/support/alvium-step-file-downloads">www.alliedvision.com/en/support/alvium-step-file-downloads</a>
Assembling Alvium Cameras from CAD Component (application note)	<a href="http://www.alliedvision.com/en/support/technical-documentation/alvium-usb-documentation">www.alliedvision.com/en/support/technical-documentation/alvium-usb-documentation</a>
<b>Accessories</b> , such as interface cables and cards, power and I/O cables, power supplies, lenses, and tripod adapters	<a href="http://www.alliedvision.com/en/products/accessories">www.alliedvision.com/en/products/accessories</a>

Table 1: Downloads for Alvium USB cameras



## Alvium Flex - more flexibility

Hardware options for standard Alvium cameras support various digital interfaces, housings, and lens mounts to enable a wide range of applications.

You have found that Alvium USB cameras with USB 3.0 Micro-B connector do not offer enough flexibility for your application? You want to use your own cables and connectors?

Alvium Flex cameras with Hirose DF40C-50DP-0.4V board-to-board connector enable individual connections. Alvium Flex accessories can be used for developing and first testing. Figure 1 shows how Add-on Boards connect to Alvium Flex cameras.

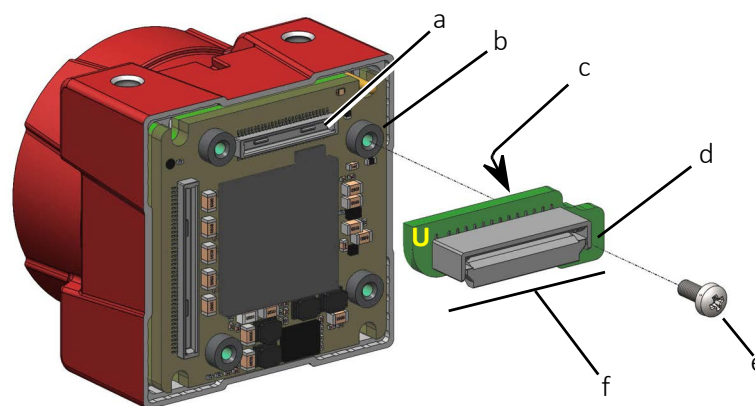

Figure 1: Alvium USB Flex camera, Interface Board, and screw

- a: Hirose DF40C-50DP-0.4V camera connector
- b: Mounting thread
- c: Hirose DF40C-50DS-0.4V board connector
- d: Mounting hole
- e: Fastening screw
- f: Add-on Board

## Alvium USB Flex

The following options are offered for **Alvium USB Flex** cameras. Above developing and testing, Alvium Flex can solve typical issues with **standard Alvium USB** cameras.

### Individual solutions

Hirose DF40 board-to-board connector enables individual connections to your own boards and cables.

## Off-the-shelf solutions

You are about to build an Alvium USB camera into your machine, but you want to separate the connectors for USB and I/Os from the camera back panel? Or you prefer to connect your Alvium USB camera to your own board without using clumsy USB cables? **Alvium USB Flex Interface Board Screw-on** enables moving the standard back panel to a new position, and it supports individual solutions.

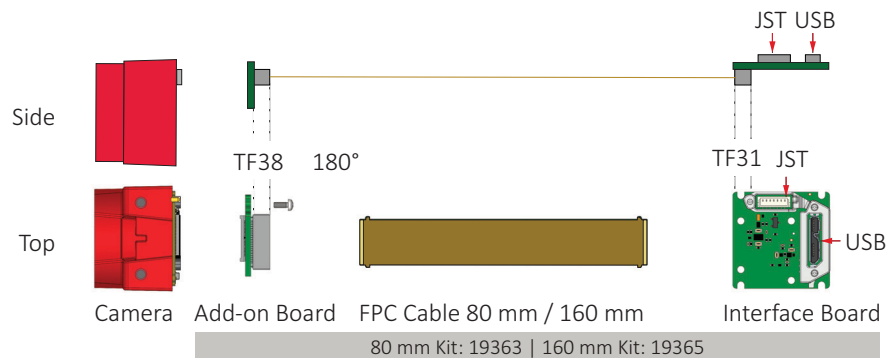

Figure 2: **Alvium USB Flex** camera connections with Interface Board Screw-on

**Alvium USB Flex Interface Board Compact** supports solutions for minimum space.

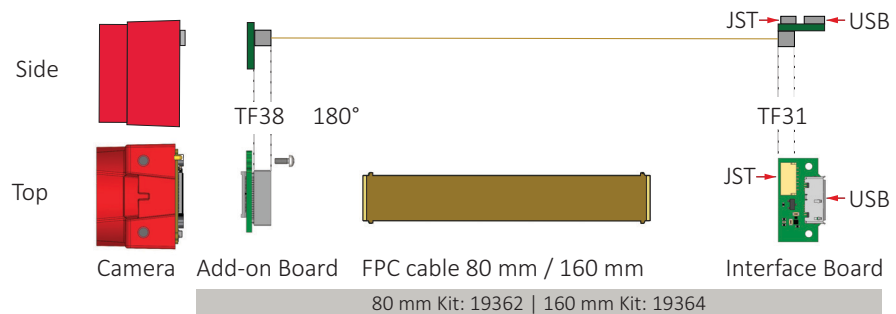

Figure 3: **Alvium USB Flex** camera connections with Interface Board Compact



### Alvium USB Flex accessory kits without interface boards

USB Add-on Board + FPC Cable 80 mm: 19367

USB Add-on Board + FPC Cable 160 mm: 19368

### Alvium Flex cameras

See contents in [Specifications](#) on page 63 and in [Camera interfaces](#) on page 275.



### Alvium Flex accessories and instructions

See the Alvium Flex Design and Accessory Guide at [www.alliedvision.com/en/support/technical-documentation/alvium-usb-documentation](http://www.alliedvision.com/en/support/technical-documentation/alvium-usb-documentation).

## Alvium Frame - use your own optical mount

You want to design your own lens mount for Alvium USB cameras or your application does not need a lens mount? In this case, Alvium Frame adds more flexibility. The square front flange with only 10 mm depth aligns to your individual housing with an extremely high accuracy.

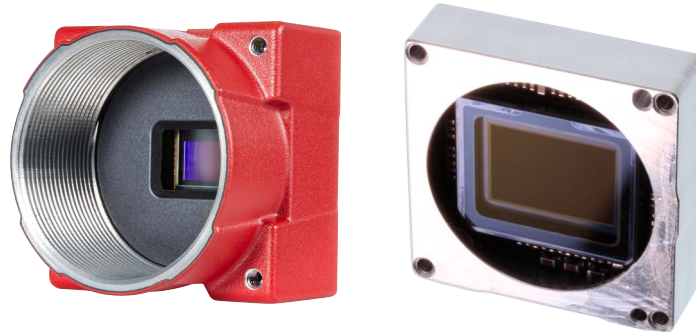

Figure 4: Standard Alvium USB open housing (left) vs. Alvium USB Frame (right)

### Specifications

- [Alvium Frame: Dimensions and mass](#) on page 227
- [Alvium Frame: Technical drawings](#) on page 227
- [Sensor position accuracy](#) on page 232

### Instructions

[Installing Alvium Frame cameras](#) on page 263:

- [Aligning the sensor with your optical system](#) on page 263
- [Mounting Alvium Frame](#) on page 264



#### Ordering Alvium Frame cameras

See the Alvium Modular Concept at [www.alliedvision.com/en/support/technical-documentation/alvium-usb-documentation](http://www.alliedvision.com/en/support/technical-documentation/alvium-usb-documentation).



#### Alvium Frame Flex

You can combine hardware options for Alvium USB Frame Flex cameras.

## Alvium Pol - using polarization (coming soon)

Alvium polarizer cameras are equipped with Sony IMX Polarsens sensors that support four-directional polarization using filters directly in front of the sensor. With these cameras, you can replace additional polarizer filters on the lens used in typical applications. In many cases, polarizer sensors can adapt easily to setups with varying polarization angles; there is no need to change or rotate optical polarization filters anymore.

You can use polarized light imaging, for example, to reduce reflections or for surface analysis regarding stress and defects. Figure 5 shows how the orientation of the polarization filters affects brightness values for the sub-images:



Figure 5: Polarization angle versus image brightness in sub-images

Current models:

- [Alvium 1800 U-507m/c Pol \(coming soon\)](#) on page 144
- [Alvium 1800 U-508m/c Pol \(coming soon\)](#) on page 151



### Please observe

For first series models, pixel processing has not been adjusted to enable the complete functionality available with non-polarizer models:

- Only raw pixel formats are supported, but no formats for polarizer sensors.
- Features based on pixel processing are available but cannot be used to generate a proper output. For example, color processing, binning, convolution filter, DPC, or FPNC are not supported.



### More information

See the Pixel based polarizer application note at [www.alliedvision.com/en/support/technical-documentation/alvium-usb-documentation](http://www.alliedvision.com/en/support/technical-documentation/alvium-usb-documentation).

# Contact us

## Website, email

### General

[www.alliedvision.com/en/contact](http://www.alliedvision.com/en/contact)  
[info@alliedvision.com](mailto:info@alliedvision.com)

### Distribution partners

[www.alliedvision.com/en/avt-locations/avt-distributors](http://www.alliedvision.com/en/avt-locations/avt-distributors)

### Support

[www.alliedvision.com/en/support](http://www.alliedvision.com/en/support)  
[www.alliedvision.com/en/about-us/contact-us/technical-support-repair-/-rma](http://www.alliedvision.com/en/about-us/contact-us/technical-support-repair-/-rma)

## Offices

### Europe, Middle East, and Africa (Headquarters)

Allied Vision Technologies GmbH  
Taschenweg 2a  
07646 Stadtroda, Germany  
T// +49 36428 677-0 (Reception)  
T// +49 36428 677-230 (Sales)  
F// +49 36428 677-28

### Asia-Pacific

#### China

Allied Vision Technologies  
(Shanghai) Co., Ltd.  
2-2109 Hongwell Int. Plaza  
1602# ZhongShanXi Road  
Shanghai 200235, China  
T// +86 21 64861133

#### Singapore

Allied Vision Technologies Asia Pte. Ltd  
82 Playfair Rd, #07-01 D'Lithium  
Singapore 368001  
T// +65 6634 9027

### North, Central, and South America

#### Canada

Allied Vision Technologies Canada Inc.  
300 – 4621 Canada Way  
Burnaby, BC V5G 4X8, Canada  
T// +1 604 875 8855

#### USA

Allied Vision Technologies, Inc.  
102 Pickering Way- Suite 502  
Exton, PA 19341, USA  
Toll-free// +1-877-USA-1394  
T// +1 978 225 2030

# Contents

Read before use	2
EN - English	2
DA - Dansk	3
DE - Deutsch	4
ES - Español	5
FI - Suomi	6
FR - Français	7
HE - עברית	8
IT - Italiano	9
JA - 日本語	10
NL - Nederlands	11
NO - Norsk	12
SV - Svenska	13
ZH - 简体中文版	14
<b>Alvium USB cameras at a glance</b>	<b>15</b>
Consider for Alvium USB cameras	16
Shipping contents	16
What else do you need?	16
Alvium Flex - more flexibility	17
Alvium USB Flex	17
Individual solutions	17
Off-the-shelf solutions	18
Alvium Frame - use your own optical mount	19
Specifications	19
Instructions	19
Alvium Pol - using polarization (coming soon)	20
<b>Contact us</b>	<b>21</b>
<b>Document history and conventions</b>	<b>31</b>
Document history	32
Conventions used in this user guide	45
Typographic styles	45
Symbols and notes	45
Naming and terms	46
Camera model naming	46
Terms and acronyms	47
<b>Compliance, safety, and intended use</b>	<b>49</b>
Camera identification	50
Compliance notifications	50
For customers in the USA	51
United States of America: Supplier Declaration of Conformity	51
Party issuing Supplier's Declaration of Conformity	51

Responsible Party - U.S. Contact Information .....	51
For customers in Canada .....	52
Pour utilisateurs au Canada .....	52
Bare board and open housing cameras .....	52
Avoid electromagnetic interferences .....	52
Intended use .....	53
Copyright and trademarks .....	53
Your safety .....	53
Handling lens mounts and Alvium Frame .....	53
Housed cameras: handling hot cameras .....	54
Providing optimum heat dissipation .....	54
Camera mounting .....	55
Heavy lenses .....	55
Product safety .....	56
Electrical connections .....	56
ESD .....	56
Cable connections .....	56
PCBAs .....	56
Camera power .....	57
GPIOs .....	57
Ground loops .....	57
Hirose DF40C-50DP-0.4V connectors .....	58
USB connections .....	58
Handling bare board cameras .....	59
Optical components .....	59
Sensor .....	60
Lenses .....	61
Mechanical components .....	61
Heat sinks .....	61
Conductive media for heat sinks .....	62
BIOS drivers .....	62
<b>Specifications .....</b>	<b>63</b>
Applied standards .....	64
GenICam .....	64
USB3 Vision 1.1 .....	64
IP class .....	64
Shock and vibration .....	64
IEC 60068-2-6: Sinusoidal vibration .....	65
IEC 60068-2-27: Shock .....	66
IEC 60068-2-64: Random vibration .....	66
Notes on specifications .....	66
Sensor .....	66
Absolute QE plots .....	66
Spectral response plots .....	67
Exposure time and frame rates .....	67
Specified values .....	67
Factors for exposure time and frame rates .....	68
Sensor ADC readout modes for maximum frame rates .....	68

Exposure time behavior regarding ExposureMode. ....	69
Operation for maximum frame rates .....	69
Frame rates with rolling shutter sensors .....	70
Sensor shutter types. ....	71
Brightness with 1800 U-812 UV cameras .....	71
Digital binning .....	71
Sensor binning. ....	71
Multiple regions .....	72
Available subregion resolutions .....	73
Operation for medium power consumption .....	74
Dimensions and mass. ....	74
Alvium 1800 U model specifications .....	76
Alvium 1800 U-030 VSWIR. ....	76
Absolute QE .....	77
ROI frame rates .....	78
Alvium 1800 U-040m/c .....	79
Absolute QE .....	81
Spectral response. ....	81
ROI frame rates .....	82
Alvium 1800 U-050m/c .....	83
Absolute QE .....	85
Spectral response. ....	85
ROI frame rates .....	86
Alvium 1800 U-052m/c .....	87
Absolute QE, spectral response .....	89
ROI frame rates .....	89
Alvium 1800 U-120m/c .....	90
Absolute QE .....	92
Spectral response. ....	92
ROI frame rates .....	93
Alvium 1800 U-130 VSWIR. ....	94
Absolute QE .....	95
ROI frame rates .....	96
Alvium 1800 U-131m/c (coming soon) .....	97
Absolute QE, spectral response .....	99
ROI frame rates .....	99
Alvium 1800 U-158m/c .....	100
Absolute QE .....	102
Spectral response. ....	102
ROI frame rates .....	103
Alvium 1800 U-192m/c (coming soon) .....	104
Absolute QE, spectral response .....	106
ROI frame rates .....	106
Alvium 1800 U-203m/c .....	107
Absolute QE, spectral response .....	109
ROI frame rates .....	109
Alvium 1800 U-234m/c .....	110
Absolute QE .....	112



Spectral response.....	112
ROI frame rates .....	113
Alvium 1800 U-235m/c .....	114
Absolute QE .....	116
Spectral response.....	116
ROI frame rates .....	117
Alvium 1800 U-240m/c .....	118
Absolute QE .....	120
Spectral response.....	120
ROI frame rates .....	121
Alvium 1800 U-291m/c .....	122
Absolute QE, spectral response .....	123
ROI frame rates .....	124
Alvium 1800 U-319m/c .....	125
Absolute QE .....	127
Spectral response.....	127
ROI frame rates .....	128
Alvium 1800 U-320 VSWIR (coming soon) .....	129
Absolute QE, spectral response .....	130
ROI frame rates .....	131
Alvium 1800 U-500m/c .....	132
Absolute QE .....	134
Spectral response.....	134
ROI frame rates .....	135
Alvium 1800 U-501m/c NIR .....	136
Absolute QE .....	138
Spectral response.....	138
ROI frame rates .....	139
Alvium 1800 U-507m/c .....	140
Absolute QE .....	142
Spectral response.....	142
ROI frame rates .....	143
Alvium 1800 U-507m/c Pol (coming soon).....	144
Absolute QE, spectral response .....	145
ROI frame rates .....	146
Alvium 1800 U-508m/c .....	147
Absolute QE .....	149
Spectral response.....	149
ROI frame rates .....	150
Alvium 1800 U-508m/c Pol (coming soon).....	151
Absolute QE, spectral response .....	152
ROI frame rates .....	153
Alvium 1800 U-510m/c .....	154
Absolute QE .....	156
Spectral response.....	156
ROI frame rates .....	157
Alvium 1800 U-511m/c .....	158
Absolute QE .....	160

Spectral response.....	160
ROI frame rates .....	161
Alvium 1800 U-530 VSWIR (coming soon) .....	162
Absolute QE, spectral response .....	163
ROI frame rates .....	164
Alvium 1800 U-811m/c .....	165
Absolute QE .....	167
Spectral response.....	167
ROI frame rates .....	168
Alvium 1800 U-812 UV.....	169
Absolute QE .....	171
Spectral response.....	171
ROI frame rates .....	172
Alvium 1800 U-895m/c .....	173
Absolute QE .....	174
Spectral response.....	174
ROI frame rates .....	175
Alvium 1800 U-1236m/c .....	176
Absolute QE .....	178
Spectral response.....	178
ROI frame rates .....	179
Alvium 1800 U-1240m/c .....	180
Absolute QE .....	182
Spectral response.....	182
ROI frame rates .....	183
Alvium 1800 U-1242m/c .....	184
Absolute QE .....	186
Spectral response.....	186
ROI frame rates .....	187
Alvium 1800 U-1620m/c .....	188
Absolute QE .....	190
Spectral response.....	190
ROI frame rates .....	191
Alvium 1800 U-2040m/c .....	192
Absolute QE .....	194
Spectral response.....	194
ROI frame rates .....	195
Alvium 1800 U-2050m/c .....	196
Absolute QE .....	198
Spectral response.....	198
ROI frame rates .....	199
Alvium 1800 U-2460m/c .....	200
Absolute QE .....	202
Spectral response.....	202
ROI frame rates .....	203
White balance default.....	204
Standard Alvium: Dimensions and mass .....	205
Bare board .....	205

Open housing 180° (standard orientation) . . . . .	205
Open housing 90° . . . . .	205
Closed housing 180° . . . . .	206
Closed housing 90° . . . . .	206
Standard Alvium: Technical drawings . . . . .	207
Bare Board 180° (standard Alvium). . . . .	208
Bare Board 90° (standard Alvium) . . . . .	208
Values in Bare Board drawings . . . . .	208
Open Housing C-Mount 180° (standard Alvium) . . . . .	210
Open Housing CS-Mount 180° (standard Alvium) . . . . .	211
Open Housing S-Mount 180° (standard Alvium) . . . . .	212
Open Housing C-Mount 90° (standard Alvium) . . . . .	213
Open Housing CS-Mount 90° (standard Alvium) . . . . .	214
Open Housing S-Mount 90° (standard Alvium) . . . . .	215
Closed Housing C-Mount 180° (standard Alvium) . . . . .	216
Closed Housing CS-Mount 180° (standard Alvium) . . . . .	217
Closed Housing S-Mount 180° (standard Alvium) . . . . .	218
Closed Housing C-Mount 90° (standard Alvium) . . . . .	219
Closed Housing CS-Mount 90° (standard Alvium) . . . . .	220
Closed Housing S-Mount 90° (standard Alvium) . . . . .	221
Alvium Flex: Dimensions and mass . . . . .	222
Bare board . . . . .	222
Open housing . . . . .	222
Alvium Flex: Technical drawings . . . . .	222
Bare Board (Alvium Flex) . . . . .	223
Open Housing C-Mount (Alvium Flex). . . . .	224
Open Housing CS-Mount (Alvium Flex). . . . .	225
Open Housing S-Mount (Alvium Flex) . . . . .	226
Alvium Frame: Dimensions and mass . . . . .	227
Alvium Frame: Technical drawings . . . . .	227
Alvium Frame 180° . . . . .	227
Alvium Frame 90° . . . . .	228
Alvium Frame Flex: Dimensions and mass . . . . .	228
Alvium Frame Flex: Technical drawings. . . . .	229
Maximum protrusion for front mounts. . . . .	230
IR cut filter . . . . .	231
Sensor position accuracy . . . . .	232
Housed standard and Flex cameras: Sensor shift and rotation . . . . .	232
Housed Alvium Frame: Sensor shift and rotation . . . . .	233
Housed Alvium USB cameras: Sensor tilt . . . . .	233
User sets. . . . .	235
Supported features. . . . .	235
Trigger features and UserSetDefault. . . . .	235
Camera feature availability. . . . .	236
<b>Lenses: Focal length vs. field of view</b> . . . . .	<b>239</b>
About this chapter. . . . .	240
Parameters in tables. . . . .	240
Optical vignetting with certain lenses . . . . .	240

About S-Mount lenses. . . . .	241
Focal length vs. field of view . . . . .	241
Alvium 1800 U-030 VSWIR. . . . .	241
Alvium 1800 U-040m/c . . . . .	242
Alvium 1800 U-050m/c . . . . .	242
Alvium 1800 U-052m/c . . . . .	243
Alvium 1800 U-120m/c . . . . .	243
Alvium 1800 U-130 VSWIR. . . . .	244
Alvium 1800 U-131m/c . . . . .	244
Alvium 1800 U-158m/c . . . . .	245
Alvium 1800 U-192m/c . . . . .	245
Alvium 1800 U-203m/c . . . . .	246
Alvium 1800 U-234m/c, -235m/c . . . . .	246
Alvium 1800 U-240m/c . . . . .	247
Alvium 1800 U-291m/c . . . . .	247
Alvium 1800 U-319m/c . . . . .	248
Alvium 1800 U-320 VSWIR. . . . .	248
Alvium 1800 U-500m/c, -501m/c NIR. . . . .	249
Alvium 1800 U-507m/c, -507m/c Pol, -508m/c, -508m/c Pol. . . . .	249
Alvium 1800 U-510m/c, -511m/c . . . . .	250
Alvium 1800 U-530 VSWIR. . . . .	250
Alvium 1800 U-811m/c, -812 UV. . . . .	251
Alvium 1800 U-895m/c . . . . .	251
Alvium 1800 U-1236m/c . . . . .	252
Alvium 1800 U-1240m/c . . . . .	252
Alvium 1800 U-1242m/c . . . . .	253
Alvium 1800 U-1620m/c . . . . .	253
Alvium 1800 U-2040m/c . . . . .	254
Alvium 1800 U-2050m/c . . . . .	254
Alvium 1800 U-2460m/c . . . . .	255
<b>Installing the camera . . . . .</b>	<b>256</b>
Touching hot cameras. . . . .	257
Sensor damage by ESD . . . . .	257
Bare board cameras . . . . .	257
Serial numbers of Alvium® chips and bare board cameras. . . . .	258
Mounting the heat sink. . . . .	259
Mounting the camera . . . . .	260
Mounting bare board cameras . . . . .	260
Mounting housed standard cameras . . . . .	262
Bottom or top mounting . . . . .	262
Front mounting. . . . .	262
Installing Alvium Frame cameras. . . . .	263
Aligning the sensor with your optical system . . . . .	263
Mounting Alvium Frame . . . . .	264
Adapting maximum torque values . . . . .	265
Mounting the lens. . . . .	265
Mounting and focusing S-Mount lenses. . . . .	266
Software and driver installation on the host . . . . .	269

Required components .....	269
Connecting the camera to the host .....	270
Connecting USB cables .....	270
Installing the camera driver using Vimba X on a Windows system .....	270
Using the camera with third-party drivers .....	270
Installing drivers for camera and host adapter .....	270
Installing the host adapter and Vimba X .....	270
Installing the camera driver .....	271
Installing the camera driver with Windows tools .....	273
<b>Camera interfaces</b> .....	<b>275</b>
Standard Alvim and Alvim Frame: Connections .....	276
Recommended accessories .....	276
Back panel .....	276
I/O connector pin assignment .....	277
Alvim Flex: Connections .....	279
Observe for DF40C-50DP-0.4V connectors .....	279
Back panel .....	279
DF40C 50DP-0.4V connector pin assignment .....	279
All Alvim USB: Connections .....	283
I/O use for UART .....	283
Power supply voltage for I/O cables .....	283
Compensation .....	283
Non-isolated, programmable GPIOs .....	284
GPIOs description .....	284
Input levels .....	285
Output levels .....	285
Status LED .....	286
Normal operation .....	286
Error conditions .....	286
<b>Triggering and timings</b> .....	<b>287</b>
Trigger signal flow .....	288
Trigger latency .....	288
Trigger features and UserSetDefault .....	289
Trigger delay with 1800 U-120 cameras .....	289
Triggering with rolling shutter cameras .....	289
Ignored triggers .....	290
<b>Image data flow</b> .....	<b>291</b>
Image data flow diagram .....	292
FPNC support .....	293
<b>Firmware update</b> .....	<b>294</b>
Please note .....	295
Firmware update with Vimba X .....	295
Updating the firmware .....	296
Error handling .....	298

Performance and troubleshooting	299
Optimizing performance	300
Image transfer with rolling shutter cameras	300
Parameter changes	300
Stopped streaming	300
Frame rate jitter	300
Value changes by feature interdependencies	301
Effects for the interdependent features	301
Impact by other features	302
Exposure times and frame rates with Sony IMX rolling shutter cameras	302
Dark current compensation	302
Additional compensation	303
Black level compensation for 1800 U-050m/c	304
Shutter types affecting image readout	305
Host setup and bandwidth	306
Sensor data output and camera data output	306
Vimba X settings	307
Requirements for USB PCIe cards and host controllers	307
Shared bandwidth on a common USB bus	308
Ideal setup for two cameras	308
Best practice for bandwidth management	308
Cascading hubs divide bandwidth	308
Using the U3 mode	309
Using SuspendMode under Linux	310
Using SuspendMode under Windows	311
Power consumption issues	312
Ensure sufficient power supply	312
Reduce the power consumption	313
Troubleshooting common issues	313
Camera recognition	314
Unexpected events	315
Performance	316
Radio signal interference	317
Index	318

# Document history and conventions



This chapter includes:

Document history .....	32
Conventions used in this user guide.....	45
Naming and terms .....	46

## Document history

Version	Date	Remarks
V4.6.1	2024-Mar-27	<b>Firmware version:</b> 00.13.01.794391f9 <ul style="list-style-type: none"> <li>Reworded <a href="#">Cable connections</a> on page 56 and added contents for using screw-lock USB cables.</li> <li>Added <a href="#">Connecting USB cables</a> on page 270.</li> </ul>
V4.6.0	2024-Mar-22	<b>Release: Firmware version:</b> 00.13.01.794391f9 <ul style="list-style-type: none"> <li>Added <a href="#">Available subregion resolutions</a> on page 73.</li> <li>Added QE curve for <a href="#">Alvium 1800 U-812 UV</a> on page 169.</li> <li>Added <i>StandbyMode</i> to <a href="#">Using the U3 mode</a> on page 309 and updated descriptions.</li> <li>Applied editorial changes.</li> </ul>
V4.5.0	2024-Mar-05	<b>Firmware version:</b> 00.13.00.71d891fe <ul style="list-style-type: none"> <li>Updated title image.</li> <li>Added introduction for <a href="#">Alvium Pol- using polarization (coming soon)</a> on page 20.</li> <li>Added contents for manufacturing conditions regarding <a href="#">Sensor cleanliness</a> on page 60.</li> <li>Added a note that the output bit depth affects the minimum available exposure times in <a href="#">Sensor ADC readout modes for maximum frame rates</a> on page 68.</li> <li>Added contents for <a href="#">Brightness with 1800 U-812 UV cameras</a> on page 71.</li> <li>Added power consumption for 1800 U-131 and -192 models in <a href="#">Alvium 1800 U model specifications</a> on page 76.</li> <li>Updated contents in <a href="#">Specifications</a> on page 63 and in <a href="#">Lenses: Focal length vs. field of view</a> on page 239:               <ul style="list-style-type: none"> <li><b>Added models coming soon:</b> 1800 U-320 VSWIR, -507 Pol, -508 Pol, and -530 VSWIR.</li> <li>Aligned sensor size values to 1 decimal place.</li> </ul> </li> <li>Updated exposure time ranges in <a href="#">Alvium 1800 U model specifications</a> on page 76.</li> </ul> <p>Continued on next page.</p>

Table 2: Document history (sheet 1 of 14)



Version	Date	Remarks
V4.5.0	2024-Mar-05	<p>Continued from previous page.</p> <ul style="list-style-type: none"> <li>Added notes that bare board cameras must be aligned by the user in <a href="#">Specifications</a> on page 63 and in <a href="#">Installing the camera</a> on page 256.</li> <li>Reduced options for Temperature monitoring to “mainboard” only in <a href="#">Camera feature availability</a> on page 236.</li> <li>Added information on <a href="#">FPNC support</a> on page 293 and updated corresponding data in <a href="#">Camera feature availability</a> on page 236.</li> <li>Renamed chapter Frame rate jitter to <a href="#">Parameter changes</a> on page 300 and added contents for stopped streaming.</li> <li>Applied editorial changes.</li> </ul>
V4.4.1	2024-Jan-02	<p><b>Firmware version:</b> 00.13.00.71d891fe</p> <p>Fixed broken weblinks.</p>
V4.4.0	2023-Dec-04	<p><b>Release: Firmware version:</b> 00.13.00.71d891fe</p> <ul style="list-style-type: none"> <li>Updated table for <a href="#">Frame rates with rolling shutter sensors</a> on page 70.</li> <li>Extended information on <a href="#">Sensor binning</a> on page 71.</li> <li>Changes to <a href="#">Alvium 1800 U model specifications</a> on page 76:           <ul style="list-style-type: none"> <li>Updated frame rates.</li> <li>Changed width resolution for 1800 U-510 and -511 from 2472 to 2464 pixels. (The width resolution for these models is 2464 with all firmware versions. In earlier versions of this user guide, 2472 pixels were specified incorrectly.)</li> <li>Added support for sensor binning for 1800 U-158m, -203m, -240m, -291m, and -508m.</li> <li>Separated Raw color pixel formats from RGB color pixel formats.</li> <li>Removed Packed pixel formats (only supported by Alvium G1 and G5).</li> </ul> </li> <li>Updated <a href="#">Camera feature availability</a> on page 236.</li> <li>Edited contents to separate between Alvium USB cameras with USB connector orientations of 90° and 180° in <a href="#">Specifications</a> on page 63.</li> </ul>

Table 2: Document history (sheet 2 of 14)

Version	Date	Remarks
V4.3.3	2023-Nov-01	<p><b>Firmware version:</b> 00.12.00.00611a22</p> <p>Added contents to avoid permanent damage to the sensor by ESD:</p> <ul style="list-style-type: none"> <li>Extended the note for <a href="#">ESD</a> on page 56.</li> <li>Added <a href="#">Possible damage to image sensors due to electrostatic charge</a> on page 60 in the product safety chapter.</li> <li>Added a warning in <a href="#">Sensor damage by ESD</a> on page 257 in the installation chapter.</li> </ul>
V4.3.2	2023-Oct-25	<p><b>Firmware version:</b> 00.12.00.00611a22</p> <ul style="list-style-type: none"> <li>Corrected mass values for closed housing 1800 U-203 models in <a href="#">Standard Alvium: Dimensions and mass</a> on page 205.</li> </ul>
V4.3.1	2023-Oct-05	<p><b>Firmware version:</b> 00.12.00.00611a22</p> <ul style="list-style-type: none"> <li>Adjusted frame rate values for <a href="#">Alvium 1800 U-131m/c (coming soon)</a> on page 97.</li> <li>Corrected images in <a href="#">Standard Alvium: Technical drawings</a> on page 207.</li> <li>Corrected data for 1800 U-131 and 1800 U-192 in <a href="#">Camera feature availability</a> on page 236.</li> </ul>
V4.3.0	2023-Sep-27	<p><b>Firmware version:</b> 00.12.00.00611a22</p> <ul style="list-style-type: none"> <li>Added 1800 U-203 models in <a href="#">Specifications</a> on page 63 and in <a href="#">Lenses: Focal length vs. field of view</a> on page 239.</li> <li>Added 1800 U-131 and 1800 U-192 models (coming soon) in <a href="#">Specifications</a> on page 63 and in <a href="#">Lenses: Focal length vs. field of view</a> on page 239.</li> <li>Updated technical drawings for bare board and open housing cameras in <a href="#">Standard Alvium: Technical drawings</a> on page 207.</li> <li>Updated <a href="#">Cooling area for Alvium USB bare board cameras</a> on page 259.</li> <li>Updated <a href="#">Mounting area of Alvium USB bare board cameras connector side (left); sensor side (right)</a> on page 261.</li> <li>Applied editorial changes.</li> </ul>

Table 2: Document history (sheet 3 of 14)

Version	Date	Remarks
V4.2.3	2023-Aug-08	<b>Firmware version:</b> 00.12.00.00611a22 <ul style="list-style-type: none"> <li>• Changed status for Alvium Flex to available and updated product codes for Alvium Flex accessories in <a href="#">Alvium Flex- more flexibility</a> on page 17.</li> <li>• Changed status for Alvium Frame to available in <a href="#">Alvium Frame- use your own optical mount</a> on page 19.</li> </ul>
V4.2.2	2023-Aug-02	<b>Firmware version:</b> 00.12.00.00611a22 Corrected values for length and mass for <a href="#">Alvium Frame: Dimensions and mass</a> on page 227 and <a href="#">Alvium Frame Flex: Dimensions and mass</a> on page 228.
V4.2.1	2023-Jul-05	<b>Firmware version:</b> 00.12.00.00611a22 <ul style="list-style-type: none"> <li>• Added 12-bit pixel formats in <a href="#">Alvium 1800 U model specifications</a> on page 76.</li> <li>• Changed horizontal resolution for 1800 U-510 and 1800 U-511 in <a href="#">Alvium 1800 U model specifications</a> on page 76.</li> </ul>
V4.2.0	2023-Jun-14	<b>Firmware version:</b> 00.12.00.00611a22 <ul style="list-style-type: none"> <li>• Added 1800 U-895m/c models in <a href="#">Alvium 1800 U model specifications</a> on page 76 and in <a href="#">Lenses: Focal length vs. field of view</a> on page 239.</li> <li>• Applied editorial changes.</li> </ul>
V4.1.0	2023-Jun-06	<b>Release: Firmware version:</b> 00.12.00.00611a22 <ul style="list-style-type: none"> <li>• Added safety notes for handling sharp edges of Alvium Frame cameras in <a href="#">Read before use</a> on page 2, <a href="#">Handling lens mounts and Alvium Frame</a> on page 53, and <a href="#">Installing Alvium Frame cameras</a> on page 263.</li> <li>• Added data on multiple regions and sensor binning for selected models in <a href="#">Alvium 1800 U model specifications</a> on page 76, in <a href="#">Camera feature availability</a> on page 236, and in <a href="#">Image data flow</a> on page 291.</li> <li>• Updated maximum frame rates for <a href="#">Alvium 1800 U-1620m/c</a> on page 188 for a resolution of 5328 (H) × 3040 (V).</li> <li>• Updated <a href="#">Serial numbers of Alvium® chips and bare board cameras</a> on page 258.</li> </ul>

Table 2: Document history (sheet 4 of 14)

Version	Date	Remarks
V4.0.0	2023-Mar-30	<b>Firmware version:</b> 00.11.00.9cf0c21e <ul style="list-style-type: none"> <li>Added contents for Alvium USB Frame in:               <ul style="list-style-type: none"> <li><a href="#">Alvium USB cameras at a glance</a> on page 15</li> <li><a href="#">Specifications</a> on page 63</li> <li><a href="#">Installing Alvium Frame cameras</a> on page 263.</li> </ul> </li> <li>Updated contents for <b>Vimba X</b>.</li> <li>Updated QE curves for 1800 U-030 VSWIR and 1800 U-130 VSWIR in <a href="#">Alvium 1800 U model specifications</a> on page 76.</li> <li>Reduced value for sensor shift with 1800 U-2050 models to 150 µm in <a href="#">Sensor position accuracy</a> on page 232.</li> <li>Added instructions to <a href="#">Firmware update</a> on page 294.</li> <li>Applied editorial changes.</li> </ul>
V3.9.1	2023-Feb-24	<b>Firmware version:</b> 00.11.00.9cf0c21e Updated page breaks to improve readability.
V3.9.0	2023-Feb-21	<b>Firmware version:</b> 00.11.00.9cf0c21e <ul style="list-style-type: none"> <li>Updated Hebrew contents in <a href="#">Read before use</a> on page 2.</li> <li>Added contents for <a href="#">Alvium Flex- more flexibility</a> on page 17, in <a href="#">Specifications</a> on page 63 and in <a href="#">Camera interfaces</a> on page 275.</li> <li>Updated <a href="#">Table 100: Bare Board and Bare Board 90° (standard Alvium and Alvium Flex) model specific dimensions and nominal values</a> on page 209.</li> <li>Removed <b>ImageChunkData</b> from <a href="#">Camera feature availability</a> on page 236.</li> <li>Updated <a href="#">Cooling area for Alvium USB bare board cameras</a> on page 259.</li> <li>Applied editorial changes.</li> </ul>
V3.8.1	2022-Nov-14	<b>Firmware version:</b> 00.11.00.9cf0c21e <ul style="list-style-type: none"> <li>Added note that lenses are not part of the product.</li> <li>Applied editorial changes.</li> </ul>

Table 2: Document history (sheet 5 of 14)

Version	Date	Remarks
V3.8.0	2022-Oct-27	<b>Release: Firmware version:</b> 00.11.00.9cf0c21e <ul style="list-style-type: none"> <li>Updated standard references in <a href="#">Applied standards</a> on page 64.</li> <li>Replaced previous calculated values for ROI frame rates by measured values in <a href="#">Specifications</a> on page 63.</li> <li>Added note on deviations from stated frame rates in <a href="#">Specified values</a> on page 67.</li> <li>Added 1800 U-510m/c models in <a href="#">Alvium 1800 U model specifications</a> on page 76 and in <a href="#">Lenses: Focal length vs. field of view</a> on page 239.</li> <li>Applied editorial changes.</li> </ul>
V3.7.5	2022-Oct-19	<b>Firmware version:</b> 00.10.00.6c9062b1 Updated ROI frame rates for 1800 U-234 and 1800 U-235 in <a href="#">Alvium 1800 U model specifications</a> on page 76.
V3.7.4	2022-Sep-22	<b>Firmware version:</b> 00.10.00.6c9062b1 Corrected entries for JST I/O cables in <a href="#">Table 146</a> on page 284.

Table 2: Document history (sheet 6 of 14)

Version	Date	Remarks
V3.7.3	2022-Sep-20	<p><b>Firmware version:</b> 00.10.00.6c9062b1</p> <ul style="list-style-type: none"> <li>• Added Hebrew contents to <a href="#">Read before use</a> on page 2.</li> <li>• Changed units KB to KByte and Mbps to MByte/s for clarity.</li> <li>• Added number for the South Korean KC Safety Certification in <a href="#">Compliance notifications</a> on page 50.</li> <li>• Corrected data in <a href="#">Alvium 1800 U model specifications</a> on page 76:           <ul style="list-style-type: none"> <li>- Max. gain for Alvium 1800 U-030 VSWIR and 1800 U-130 VSWIR was changed to 42 dB.</li> <li>- 12-bit pixel formats were added to Alvium 1800 U-234 and 1800 U-235 models.</li> <li>- Updated exposure time vales in tables with ROI frame rates for Alvium 1800 U-812 UV.</li> <li>- Corrected sensor bit depth values to 10-bit for ROI frame rates of 1800 U-1240.</li> <li>- Removed FPNC availability for 1800 U-234 and 1800 U-235.</li> </ul> </li> <li>• Added a note in <a href="#">Image data flow</a> on page 291 that 1800 U-234 and 1800 U-235 models currently do not support FPNC.</li> <li>• Applied editorial changes.</li> </ul>
V3.7.2	2022-Aug-05	<p><b>Firmware version:</b> 00.10.00.6c9062b1</p> <p>Removed “Coming soon” status for <a href="#">Alvium 1800 U-812 UV</a> on page 169.</p>
V3.7.1	2022-Jul-22	<p><b>Firmware version:</b> 00.10.00.6c9062b1</p> <ul style="list-style-type: none"> <li>• Added values for minimum and maximum exposure times in <a href="#">Alvium 1800 U model specifications</a> on page 76.</li> <li>• Corrected dimensions for screws from M2 to M1.6 in <a href="#">Mounting bare board cameras</a> on page 260.</li> </ul>

Table 2: Document history (sheet 7 of 14)

Version	Date	Remarks
V3.7.0	2022-Jul-14	<p><b>Release: Firmware version:</b> 00.10.00.6c9062b1</p> <ul style="list-style-type: none"> <li>Added <a href="#">Camera identification</a> on page 50, including Model ID for DoC assignment.</li> <li>Added symbol for South Korean KC Safety Certification in <a href="#">Compliance notifications</a> on page 50.</li> <li>Updated data in <a href="#">Specifications</a> on page 63 for:               <ul style="list-style-type: none"> <li>ROI frame rates and exposure time ranges</li> <li>Maximum gain for Sony IMX global shutter cameras increased to 48 dB</li> <li>Exposure Mode of various models.</li> </ul> </li> <li>Added 1800 U-234m/c, 1800 U-235m/c, and 1800 U-812 UV models in <a href="#">Alvium 1800 U model specifications</a> on page 76 and in <a href="#">Lenses: Focal length vs. field of view</a> on page 239.</li> <li>Added the information that Alvium 1800 U-511 is supplied on request only to <a href="#">Sensor position accuracy</a> on page 232.</li> <li>Added new functionalities to <a href="#">Camera feature availability</a> on page 236.</li> <li>Added warning against voltage levels of serial communication in <a href="#">I/O connector pin assignment</a> on page 277.</li> <li>Added <a href="#">I/O use for UART</a> on page 283.</li> <li>Removed FPNC support for VSWIR models and added DPC support for 1800 U-052 and 1800 U-291 in <a href="#">Image data flow</a> on page 291.</li> <li>Removed the section “Feature value changes on a streaming camera” from <a href="#">Optimizing performance</a> on page 300.</li> <li>Applied editorial changes.</li> </ul>
V3.6.4	2022-Apr-12	<p><b>Firmware version:</b> 00.08.00.6727174b</p> <ul style="list-style-type: none"> <li>Added notes that Alvium 1800 U-052 and 1800 U-291 currently do not support DPC and FPNC to <a href="#">Image data flow</a> on page 291.</li> <li>Applied minor editorial changes.</li> </ul>
V3.6.3	2022-Mar-29	<p><b>Firmware version:</b> 00.08.00.6727174b</p> <p>Re added values for Alvium 1800 U-319c in <a href="#">White balance default</a> on page 204.</p>

Table 2: Document history (sheet 8 of 14)

Version	Date	Remarks
V3.6.2	2022-Mar-25	<b>Firmware version:</b> 00.08.00.6727174b Updated mass values for closed housing Alvium 1800 U-158m/c at <a href="#">Standard Alvium: Dimensions and mass</a> on page 205.
V3.6.1	2022-Mar-17	<b>Firmware version:</b> 00.08.00.6727174b Renamed Alvium 1800 U-030m <b>VSWIR</b> to Alvium 1800 U-030 <b>VSWIR</b> , and Alvium 1800 U-130m <b>VSWIR</b> correspondingly.
V3.6.0	2022-Mar-15	<b>Release: Firmware version:</b> 00.08.00.6727174b <ul style="list-style-type: none"> <li>• Added <a href="#">Sensor ADC readout modes for maximum frame rates</a> on page 68.</li> <li>• Updated conditions for <a href="#">Operation for maximum frame rates</a> on page 69 and renamed <a href="#">Operation for medium power consumption</a> on page 74.</li> <li>• Updated frame rates for model specifications tables and ROI frame rates in <a href="#">Alvium 1800 U model specifications</a> on page 76.</li> <li>• Added note about frame rates in triggered mode for <a href="#">Alvium 1800 U-120m/c</a> on page 90.</li> <li>• Corrected options for Exposure Modes in <a href="#">Alvium 1800 U-1240m/c</a> on page 180.</li> <li>• Added note for non-standard S-Mount hardware options in <a href="#">Sensor position accuracy</a> on page 232.</li> <li>• Added new section on <a href="#">User sets</a> on page 235.</li> <li>• Added <a href="#">Camera feature availability</a> on page 236.</li> <li>• Added information on <a href="#">Ignored triggers</a> on page 290.</li> <li>• Updated workflows in <a href="#">Image data flow</a> on page 291 for new convolution filters, and in <a href="#">Value changes by feature interdependencies</a> on page 301.</li> <li>• Added new section <a href="#">Power consumption issues</a> on page 312 and updated related</li> <li>• Added <a href="#">Requirements for USB PCIe cards and host controllers</a> on page 307.</li> <li>• Applied minor editorial changes.</li> </ul>
V3.5.1	2021-Nov-23	<b>Firmware version:</b> 00.07.00.81db3896 <ul style="list-style-type: none"> <li>• Updated links to accessories.</li> <li>• Applied minor editorial changes.</li> </ul>

Table 2: Document history (sheet 9 of 14)



Version	Date	Remarks
V3.5.0	2021-Nov-05	<p><b>Release: Firmware version:</b> 00.07.00.81db3896</p> <ul style="list-style-type: none"> <li>Added 1800 U-030m and 1800 U-130m models in <a href="#">Specifications</a> on page 63 and in <a href="#">Lenses: Focal length vs. field of view</a> on page 239.</li> <li>Updated information in <a href="#">Digital binning</a> on page 71.</li> <li>Updated the minimum temperature value for operation and storage from +5 °C to -20 °C.</li> <li>Added contents for <a href="#">Power supply voltage for I/O cables</a> on page 283.</li> <li>Updated workflow in <a href="#">Image data flow</a> on page 291 for new LUT and Sharpness.</li> <li>Updated diagram in <a href="#">Value changes by feature interdependencies</a> on page 301.</li> <li>Applied minor editorial changes.</li> </ul>
V3.4.2	2021-Aug-17	<p><b>Firmware version:</b> 00.06.00.35992</p> <ul style="list-style-type: none"> <li>Added icon for compliance with UKCA in <a href="#">Compliance notifications</a> on page 50.</li> <li>Corrected sensor specifications for <a href="#">Alvium 1800 U-1242m/c</a> on page 184.</li> <li>Applied editorial changes.</li> </ul>
V3.4.1	2021-Aug-09	<p><b>Firmware version:</b> 00.06.00.35992</p> <ul style="list-style-type: none"> <li>Adjusted conditions for <a href="#">Operation for maximum frame rates</a> on page 69.</li> <li>Corrected binning ranges in the model specifications in <a href="#">Alvium 1800 U model specifications</a> on page 76.</li> <li>Applied editorial changes.</li> </ul>

Table 2: Document history (sheet 10 of 14)

Version	Date	Remarks
V3.4.0	2021-Aug-05	<p><b>Release: Firmware version:</b> 00.06.00.35992</p> <ul style="list-style-type: none"> <li>Added 1800 U-120 model to <a href="#">Frame rate jitter</a> on page 300 and <a href="#">Trigger delay with 1800 U-120 cameras</a> on page 289.</li> <li>Added 1800 U-511m/c, 1800 U-811m/c, and 800 U-1242m/c models in <a href="#">Alvium 1800 U model specifications</a> on page 76.</li> <li>For all models, added <a href="#">Digital binning</a> on page 71.</li> <li>Updated tables with ROI frame rates in <a href="#">Specifications</a> on page 63, with new bandwidth steps, extended to 450 MByte/s.</li> <li>Removed the previous section <b>Performance on reference systems</b> from <a href="#">Optimizing performance</a> on page 300.</li> <li>Added instructions for <a href="#">Using the U3 mode</a> on page 309.</li> </ul>
V3.3.0	2021-Apr-12	<p><b>Release: Firmware version:</b> 00.04.00.34658</p> <ul style="list-style-type: none"> <li>Updated <a href="#">ROI frame rates</a> on page 86 for 1800 U-120m/c models.</li> <li>Added 1800 U-501c NIR, 1800 U-1620m/c, 1800 U-2040m/c, and 1800 U-2460m/c models in <a href="#">Alvium 1800 U model specifications</a> on page 76.</li> <li>Updated mass values in <a href="#">Standard Alvium: Dimensions and mass</a> on page 205.</li> <li>Updated instructions for <a href="#">Mounting the camera</a> on page 260.</li> <li>Applied editorial changes.</li> </ul>
V3.2.2	2021-Jan-22	<p><b>Firmware version:</b> 00.03.00.31919</p> <ul style="list-style-type: none"> <li>Updated pixel formats in <a href="#">Alvium 1800 U model specifications</a> on page 76.</li> <li>Applied editorial changes.</li> </ul>

Table 2: Document history (sheet 11 of 14)

Version	Date	Remarks
V3.2.1	2020-Dec-15	<p><b>Release: Firmware version:</b> 00.03.00.31919</p> <ul style="list-style-type: none"> <li>Added information on the exposure time offset in <a href="#">Exposure time behavior regarding ExposureMode</a> on page 69.</li> <li>Updated values for ROI frame rates and for minimum and maximum exposure time in <a href="#">Alvium 1800 U model specifications</a> on page 76.</li> <li>Added values for <a href="#">White balance default</a> on page 204.</li> <li>Updated drawings and dimension values for bare board cameras in <a href="#">Standard Alvium: Technical drawings</a> on page 207.</li> <li>Added information about <a href="#">Serial numbers of Alvium® chips and bare board cameras</a> on page 258.</li> <li>Added description for push-pull in <a href="#">GPIOs description</a> on page 284.</li> <li>Added <a href="#">Trigger features and UserSetDefault</a> on page 289.</li> <li>In <a href="#">Image data flow</a> on page 291, added FPNC support for all models, except for Alvium 1800 U-2050.</li> <li>Added notes about frame rates for rolling shutter cameras run in triggered mode.</li> <li>Applied editorial changes.</li> </ul>
V3.2.0	2020-Jul-22	<p><b>Release: Firmware version:</b> 00.02.00.29974</p> <ul style="list-style-type: none"> <li>Added Alvium 1800 U-240m/c, 1800 U-508m/c, and 1800 U-1240m/c models.</li> <li>Updated ROI frame rates and pixel formats in <a href="#">Alvium 1800 U model specifications</a> on page 76.</li> <li>Added QE and spectral response to <a href="#">Alvium 1800 U-2050m/c</a> on page 196.</li> <li>Extended information in <a href="#">Shock and vibration</a> on page 64.</li> <li>Updated spectral response graphic in <a href="#">IR cut filter</a> on page 231.</li> <li>Added <a href="#">Sensor position accuracy</a> on page 232.</li> <li>Added <a href="#">Read before use</a> on page 2.</li> <li>Corrected minor errors.</li> </ul>

Table 2: Document history (sheet 12 of 14)

Version	Date	Remarks
V3.1.3	2020-Mar-12	<b>Firmware version:</b> 00.01.03.29025 <ul style="list-style-type: none"> <li>• Corrected maximum exposure times.</li> <li>• Added <i>ExposureActive</i> signal to the description of sensor shutter modes.</li> <li>• DPC: Removed specifications into an application note.</li> <li>• FPNC: Updated note in <a href="#">Image data flow</a> on page 291.</li> </ul>
V3.1.2	2020-Mar-04	<b>Firmware version:</b> 00.01.03.29025 Applied minor changes.
V3.1.1	2020-Feb-28	<b>Firmware version:</b> 00.01.03.29025 <ul style="list-style-type: none"> <li>• Updated frame rates and exposure time values.</li> <li>• Added information about frame rates with different triggering modes.</li> </ul>
V3.1.0	2020-Feb-20	<b>Release: Firmware version:</b> 00.01.03.29025 <ul style="list-style-type: none"> <li>• Added Alvium 1800 U-319m/c, 1800 U-507m/c, 1800 U-1236m/c, and 1800 U-2050m/c models.</li> <li>• Added specifications for DPC.</li> <li>• Updated description for sensor shutter modes.</li> </ul>
V3.0.0	2020-Jan-06	<b>Release: Firmware version:</b> 00.01.02.28100 <ul style="list-style-type: none"> <li>• Added Alvium 1800 U-040m/c, 1800 U-158m/c, and 1800 U-501m NIR models.</li> </ul>
V2.0.0	2019-Oct-18	<b>Release: Firmware version:</b> 00.01.01.27102 <ul style="list-style-type: none"> <li>• Added Alvium 1800 U-050m/c and 1800 U-120m/c models.</li> <li>• Updated contents about bandwidth.</li> <li>• Updated screenshots for camera driver installation.</li> <li>• Added <a href="#">Dark current compensation</a> on page 302.</li> <li>• Updated technical drawings and dimensions for bare board in <a href="#">Standard Alvium: Technical drawings</a> on page 207.</li> <li>• Restructured contents in <a href="#">Performance and troubleshooting</a> on page 299.</li> <li>• Applied editorial changes.</li> </ul>

Table 2: Document history (sheet 13 of 14)

Version	Date	Remarks
V1.1.0	2019-Jul-01	<b>Firmware version:</b> 00.01.00.26405 <ul style="list-style-type: none"> <li>Added missing color pixel formats and removed separate bit depth in <a href="#">Specifications</a> on page 63.</li> <li>Corrected ADC bit depth in specifications for <a href="#">Alvium 1800 U-500m/c</a> on page 132 and in <a href="#">Image data flow</a> on page 291.</li> </ul>
V1.0.0	2019-Jun-13	<b>Release: Firmware version:</b> 00.01.00.26405 Release version

Table 2: Document history (sheet 14 of 14)

## Conventions used in this user guide

To give this document an easily understood layout and to emphasize important information, the following typographical styles and symbols are used:

### Typographic styles

Style	Function
<b>Emphasis</b>	Programs, or highlighting important things
Feature names	Names for GenICam features
<i>Feature options</i>	Options for GenICam features
<i>Input commands</i>	Text or command to type in by the user, selected menu options, or other selectable options
<b>UIElements</b>	Text that is displayed or output by the system, like parts of the GUI, dialog boxes, buttons, menus, important information, or windows titles
<a href="#">Web addresses and references</a>	Links to webpages and internal cross references

Table 3: Typographic styles

### Symbols and notes



#### CAUTION

##### Risk of burns

Precautions are described



#### CAUTION

##### Injury by falling cameras or lenses

Precautions are described

**CAUTION**
**Risk of cuts by sharp edges**

Precautions are described

**NOTICE**
**Material damage**

Precautions are described.

**Practical tip**

Additional information helps to understand or ease handling the camera.

**Avoiding malfunctions**

Precautions are described.

**Additional information**

Web address or reference to an external source with more information is shown.

## Naming and terms

### Camera model naming

Alvium cameras are named to identify model properties.  
For example, **Alvium 1800 U-500c** is composed of:

	<b>Alvium</b>	<b>1800</b>	<b>U</b>	<b>500</b>	<b>c</b>
<b>Content</b>	Camera series	Camera series details	Interface	Resolution <sup>1</sup>	Color/ monochrome
<b>Examples</b>	Alvium	1500: Basic feature set 1800: Advanced feature set or high-performance sensors	C: MIPI CSI-2 U: USB	500: 5.0 MP 050: 0.5 MP	c: color m: monochrome m NIR: monochrome near infrared

<sup>1</sup>Model resolutions may slightly deviate from model naming.

*Table 4: Camera model naming*

## Terms and acronyms

Term or acronym	Description	Reference
bare board	Camera consisting of electronics and sensor on a common printed circuit board (PCB), to be designed into a housing with heat sink and lens mount	<a href="#">Bare Board 180° (standard Alvium)</a> on page 208
CRA	Chief ray angle	<a href="#">Alvium 1800 U-500m/c</a> on page 132
EMVA	European Machine Vision Association	<a href="http://www.emva.org">www.emva.org</a>
ERS	Electronic rolling shutter, see RS	<a href="#">Shutter types affecting image readout</a> on page 305
ESD	Electrostatic discharge	<a href="#">ESD</a> on page 56
FCC	Federal Communications Commission	<a href="#">For customers in the USA</a> on page 51
FPNC	Fixed pattern noise correction	<a href="#">Image data flow</a> on page 291
fps	Frames per second	<a href="#">Alvium 1800 U-500m/c</a> on page 132
GenICam	Generic Interface for Cameras, EMVA	<a href="http://www.emva.org">www.emva.org</a>
GND	Ground (power)	<a href="#">I/O connector pin assignment</a> on page 277
GPIOs	General purpose inputs and outputs (non-isolated)	<a href="#">GPIOs description</a> on page 284
GRRS	Global reset release shutter, see GRS	<a href="#">Shutter types affecting image readout</a> on page 305
GRS	Global reset shutter, see GRRS	<a href="#">Shutter types affecting image readout</a> on page 305
GS	Global shutter	<a href="#">Shutter types affecting image readout</a> on page 305
H × V	Horizontal × Vertical (sensor resolution)	<a href="#">Alvium 1800 U-500m/c</a> on page 132
KByte	Kilobyte	<a href="#">Alvium 1800 U-500m/c</a> on page 132
MByte/s	Megabytes per second	<a href="#">Alvium 1800 U-500m/c</a> on page 132
MP	Megapixels (see P)	<a href="#">Alvium 1800 U model specifications</a> on page 76
open housing	Camera housing that is open at the back side to be designed into an encompassing housing with other components	<a href="#">Open Housing S-Mount 180° (standard Alvium)</a> on page 212
P	Pixels (see MP)	<a href="#">Alvium 1800 U model specifications</a> on page 76
PCBA	Printed circuit board assembly	<a href="#">PCBAs</a> on page 56
QE	Quantum efficiency	<a href="#">Absolute QE</a> on page 134
ROI	Region of interest	<a href="#">ROI frame rates</a> on page 135

Table 5: Terms and acronyms (sheet 1 of 2)

Term or acronym	Description	Reference
RS	Rolling shutter, see ERS	<a href="#">Shutter types affecting image readout on page 305</a>
SFNC	Standard Features Naming Convention (GenICam)	<a href="http://www.emva.org">www.emva.org</a>
shutter mode	Value of the <b>ShutterMode</b> feature to select between rolling shutter (RS) and global release shutter (GRS)	<a href="#">Frame rates with rolling shutter sensors on page 70</a>
shutter type	Sensor specific readout, such as rolling shutter (RS) or global shutter (GS)	<a href="#">Shutter types affecting image readout on page 305</a>
S-Mount	M12-Mount	<a href="#">Mounting and focusing S-Mount lenses on page 266</a>

*Table 5: Terms and acronyms (sheet 2 of 2)*



# Compliance, safety, and intended use



This chapter includes:

Camera identification.....	50
Compliance notifications .....	50
Intended use .....	53
Copyright and trademarks .....	53
Your safety.....	53
Product safety .....	56

## Camera identification

You can identify your Alvium USB **housing camera** like this:



Figure 6: Hardware options and model IDs

Hardware option	Model ID
<b>Closed housing standard</b> Alvium USB	A 1 E
<b>Open housing standard</b> Alvium USB	A 1 D
<b>Open housing</b> Alvium USB <b>Flex</b>	A 1 N
<b>Open housing</b> Alvium USB <b>Frame</b>	A 1 D
<b>Open housing</b> Alvium USB <b>Frame Flex</b>	A 1 N

Table 6: Hardware options and model IDs

Model IDs are the same for standard (180°) and 90° USB connector orientation.

The variants of standard Alvium USB cameras with closed housing (model ID: A 1 E) are **KC certified**. Bare board cameras and open housing cameras are unfinished devices that require housing by the customer for EMC compliance and hence cannot be KC certified.

Preparations to introduce Model IDs for Alvium **bare board cameras** are ongoing. Corresponding data will be added to a future version of this document.

## Compliance notifications



National regulations on disposal must be followed.

## For customers in the USA

### **Closed housing cameras only: FCC Class B digital device**

This equipment has been tested and found to comply with the limits for a Class B digital device, pursuant to part 15 of the FCC Rules. These limits are designed to provide reasonable protection against harmful interference in a residential installation. This equipment generates, uses and can radiate radio frequency energy and, if not installed and used in accordance with the instructions, may cause harmful interference to radio communications. However, there is no guarantee that interference will not occur in a particular installation. If this equipment does cause harmful interference to radio or television reception, which can be determined by turning the equipment off and on, the user is encouraged to try to correct the interference by one or more of the following measures:

- Reorient or relocate the receiving antenna.
- Increase the separation between the equipment and receiver.
- Connect the equipment into an outlet on a circuit different from that to which the receiver is connected.
- Consult the dealer or an experienced radio/TV technician for help.

## United States of America: Supplier Declaration of Conformity

Alvium USB cameras comply with Part 15 of the FCC Rules. Operation is subject to the following two conditions:

1. This device may not cause harmful interference, and
2. This device must accept any interference received, including interference that may cause undesired operation.

### **Party issuing Supplier's Declaration of Conformity**

Allied Vision Technologies GmbH  
Taschenweg 2a  
07646 Stadtroda  
Germany  
T// +49 (36428) 677-106  
quality@alliedvision.com

### **Responsible Party - U.S. Contact Information**

Allied Vision Technologies, Inc.  
102 Pickering Way – Suite 502  
Exton, PA 19341  
USA  
T// +1 978 225 2030

**Note:** changes or modifications not expressly approved by the party responsible for compliance could void the user's authority to operate the equipment.

## For customers in Canada

### Closed housing cameras only

This apparatus complies with the Class B limits for radio noise emissions set out in the Radio Interference Regulations.

CAN ICES-3 (B) / NMB-3 (B)

## Pour utilisateurs au Canada

### Boîtier de caméra fermé seulement

Cet appareil est conforme aux normes classe B pour bruits radioélectriques, spécifiées dans le Règlement sur le brouillage radioélectrique.

CAN ICES-3 (B) / NMB-3 (B)

## Bare board and open housing cameras

Bare board cameras and open housing cameras are unfinished devices that are not EMC compliant in themselves. To meet EMC requirements, they must be appropriately housed in the customer's device and under the customer's responsibility.



### Requirements for EMC housings

See the Electromagnetic Compatibility for Open Housing Alvium Cameras application note at [www.alliedvision.com/en/support/technical-documentation/alvium-usb-documentation](http://www.alliedvision.com/en/support/technical-documentation/alvium-usb-documentation).

## Avoid electromagnetic interferences

Interface cables, power cables, and I/O cables are sensitive to electromagnetic interference.

- Use shielded cables only.
- We recommend using cables offered by Allied Vision.
- Avoid coiling.
- We recommend using GPIOs only in environments with low electromagnetic interference.

Moreover, avoid unnecessary bending to prevent damage to the cables.

## Intended use

Allied Vision's objective is the development, design, production, maintenance, servicing and distribution of digital cameras and components for image processing. We are offering standard products as well as customized solutions.

Intended use of Allied Vision product is the integration into Vision systems by professionals. All Allied Vision product is sold in a B2B setting.

Allied Vision isn't a legal manufacturer of medical product. Instead, Allied Vision cameras and accessories may be used as components for medical product after design-in by the medical device manufacturer and based on a quality assurance agreement (QAA) between Allied Vision (supplier) and medical device manufacturer (customer). Allied Vision's duties in that respect are defined by ISO 13485, clause 7.2 (customer-related processes, equivalent to ISO 9001, clause 8.2).

## Copyright and trademarks

All text, pictures, and graphics are protected by copyright and other laws protecting intellectual property. All content is subject to change without notice.

All trademarks, logos, and brands cited in this document are property and/or copyright material of their respective owners. Use of these trademarks, logos, and brands does not imply endorsement.

Copyright © 2024 Allied Vision Technologies GmbH. All rights reserved.

## Your safety

This section informs about issues related to your personal safety. Descriptions explain how to avoid hazards and operate Alvium USB cameras safely.

### Handling lens mounts and Alvium Frame

The lens mount thread can have sharp edges. Be careful these edges do not cut your skin when mounting or unmounting lenses.

The circular front opening of Alvium Frame cameras has sharp edges.

- Avoid touching these edges with your fingers.
- Wear protective gloves for handling Alvium Frame cameras with an open circular front opening.
- Follow the instructions in [Installing Alvium Frame cameras](#) on page 263.

## Housed cameras: handling hot cameras

If the mainboard temperature exceeds the specified maximum for more than two seconds, the camera is powered off automatically. The current value for mainboard temperature is output by `DeviceTemperature`. You can use this value to control cooling by software, for example, to control a fan.

However, if you hold the camera in your hands during operation, your skin may get hurt. If you touch the camera when it is heated up, we recommend wearing protective gloves.

## Providing optimum heat dissipation

Design bare board and open housing cameras into a heat dissipative housing with a high thermal conductivity. For more information, see [Mounting bare board cameras](#) on page 260. Keep the operating temperature in the specified range to enable best image quality and to protect the camera from damage. Temperature values apply to a relative humidity of 0 to 80 percent that is non-condensing.

Hardware option	Housing	Components in the cooling area <sup>1</sup>	Mainboard <sup>2</sup>
Bare board <sup>3</sup>	Not applicable	-20 °C to +85 °C	See model <a href="#">Specifications</a> on page 63.
Open housing <sup>4</sup>	-20 °C to +65 °C		
Closed housing		Not applicable	

<sup>1</sup>See [Mounting the heat sink](#) on page 259.

<sup>2</sup>Output by `DeviceTemperature`

<sup>3</sup>Ensure that the sensor is operated in the temperature range specified by the manufacturer. For any questions, please visit [www.alliedvision.com/en/support](http://www.alliedvision.com/en/support).

<sup>4</sup>Temperature values must be observed for the housing **and** for the cooling area.

*Table 7: Operating temperature ranges for Alvium USB cameras*

For your safety and to improve camera performance, operate the camera:

- Mounted to a base with a high thermal conductivity
- With lens or other optical components mounted
- With a heat sink mounted that has large surface areas (closed housing cameras include a heat sink)
- Using conductive media for camera and heat sink mounting
- With active cooling of camera, mounting base, and heat sink, such as by ventilation.
- Reduce high ambient temperature. For example, in outdoor applications with direct sunlight, provide shading by an enclosure.

See [Figure 7: Setup to provide optimum heat dissipation](#) on page 55.

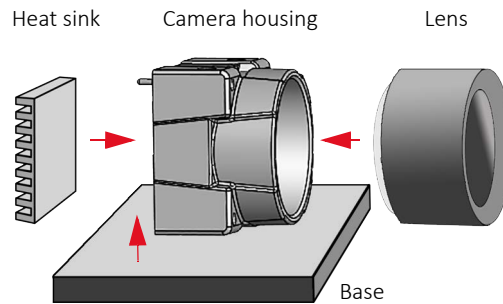

Figure 7: Setup to provide optimum heat dissipation



### More information

For more information on heat dissipation, see the Optimum Heat Dissipation for Housed Alvium Cameras application note at [www.alliedvision.com/en/support/technical-documentation/alvium-usb-documentation](http://www.alliedvision.com/en/support/technical-documentation/alvium-usb-documentation).

## Camera mounting

Housed cameras must be mounted using the mounting threads. If vibration is higher than specified, cameras can disconnect from the mounting base. Falling cameras can hurt you. To avoid personal injury:

- Mount the camera according to the instructions in [Mounting housed standard cameras](#) on page 262.
- Ensure, shock and vibration do not exceed the specified range, see [Shock and vibration](#) on page 64.
- Use a lens support if you want to use [Heavy lenses](#).

## Heavy lenses

For non-static applications, use lenses with a mass less than 70 grams and a length less than 38 mm, where the center of gravity is 20 mm, measured from the lens mount front flange. For heavier or longer lenses, use a lens support and apply additional tests. For more information, please contact support at [www.alliedvision.com/en/about-us/contact-us/technical-support-repair/-/rma](http://www.alliedvision.com/en/about-us/contact-us/technical-support-repair/-/rma).

## Product safety

To prevent material damage, read the following and understand how to safely handle and operate the camera. Get helpful details about electrical connections and learn how to optimize camera performance.

### Electrical connections

#### ESD

Follow these instructions to avoid damage to the camera, including possible **damage to the sensor**, see [Possible damage to image sensors due to electrostatic charge](#) on page 60. ESD is dangerous for electronic devices, especially when tools or hands get in contact with connectors and electronic components. We recommend measures to avoid damage by ESD:

- Unpacking: Remove the camera from its anti-static packaging only when your body is grounded.
- Workplace: Use a static-safe workplace with static-dissipative mat and air ionization.
- Wrist strap: Wear a static-dissipative wrist strap to ground your body.
- Clothing: Wear ESD clothing. Keep components away from your body and clothing. Even if you are wearing a wrist strap, your body is grounded but your clothes are not.
- Bare board and open housing cameras: use a special ESD housing.

#### Cable connections

Micro USB 3.0 ports are intended for use in office applications. The USB3 Vision Standard enhances the USB 3.0 Standard by adding a screw-locking mechanism to better suit industrial applications. We recommend using only screw-lock USB cables to avoid damage to cameras, enhancing the durability and performance of cameras, and ensuring a seamless experience.

- Fasten screw-lock connectors before you start camera operation.
- Provide sufficient strain relief for all cable connections to avoid camera damage.



#### Compatible USB 3.0 cables

For USB 3.0 interface cables, industrial grade, with screw locks, Standard-A to Micro-B, see [www.alliedvision.com/en/products/accessories](http://www.alliedvision.com/en/products/accessories).

#### PCBAs

Alvium USB cameras enable access to PCBAs. Keep away from camera electronics to avoid damage.



## Camera power



### Alvium USB Flex cameras

Please apply the contents below depending on the camera connection of your individual application.

Operating the camera beyond the specified range damages the camera.

**Standard Alvium USB** cameras are powered over USB. Alternatively, cameras can be powered using the I/O connector at a maximum input of 5.5 VDC, using a limited power source (LPS), according to IEC 62368-1 with minimum 1.5 A. The camera is not intended to be connected to a DC distribution network.

- Make sure that USB 3.0 or 3.1 Gen 1 host controller cards, on-board host controllers, or hubs provide sufficient current supply for the connected cameras.
- Only use power supplies that meet the insulation requirement according to PELV or SELV. For details, please refer to IEC 61140.
- We recommend using powered hubs, especially for multi-camera operation.



### Alvium accessories

For suitable USB accessories, see [www.alliedvision.com/en/products/accessories](http://www.alliedvision.com/en/products/accessories).

## GPIOs

To avoid damage to the camera, keep maximum input voltage below 5.5 VDC and maximum current below 12 mA per output. See [Specifications](#) on page 63 for details. The maximum length for I/O cables must not exceed 30 meters.

## Reverse polarity

If Alvium USB cameras are externally powered with reverse polarity, the cameras can be damaged. See [I/O connector pin assignment](#) on page 277 for proper external power connections.

## JST-cables

JST I/O cables without shielding are designed to be used with bare board or open housing Alvium cameras. The customer is responsible for an EMC compliant design. For applications without an additional EMC housing, please use shielded JST I/O cables with screw lock.

## Ground loops

Unsuitable connections can lead to different potentials between the camera system GND and the environmental shield/chassis GND caused by ground loops. This can damage the camera and the connected devices or cause malfunctions.

- Avoid potential differences between the camera housing and GND.
- All wiring must be done by authorized personnel, according to the corresponding technical standards.
- You may mount the camera electrically isolated.
- Read the Avoiding Ground Loops in Vision Systems application note.



#### More information

See the Avoiding Ground Loops in Vision Systems application note at [www.alliedvision.com/en/support/technical-documentation/alvium-usb-documentation](http://www.alliedvision.com/en/support/technical-documentation/alvium-usb-documentation).

## Hirose DF40C-50DP-0.4V connectors

Hirose DF40C-50DP-0.4V board-to-board connectors enable compact camera design.

The small-sized connectors are sensitive to mechanical stress and are specified for maximum 20 mating and unmating cycles. Especially if you are inexperienced with these connectors, be very cautious. If these connectors are broken, cameras must be replaced. To install and operate cameras safely, read this section carefully.



#### Additional information

For technical data and more instructions on the Hirose connectors, see the manufacturer data sheet at [www.hirose.com](http://www.hirose.com).

## USB connections

### USB 3.0 and 3.1 Gen 1 host controllers and hubs

To avoid damage to USB 3.0 or 3.1 Gen 1 host controller cards or hubs, make sure these components provide sufficient current supply for the connected cameras. For suitable USB 3.0 accessories, see [www.alliedvision.com/en/products/accessories](http://www.alliedvision.com/en/products/accessories).

If suddenly your camera is not recognized anymore, check for a crashed USB hub. Disconnect the USB and power supply cable from the hub. Reconnect both.

### USB cables

Proper cable handling enables reliable performance:

- Use only shielded cables to avoid electromagnetic interferences.
- Please use cables recommended by Allied Vision.
- Avoid unnecessary bending to prevent damage to the cables.
- Avoid coiling to prevent electromagnetic interference.

### Alvium USB cameras and USB 2.0

If Alvium USB cameras are connected to USB 2.0 ports, they are recognized. They can be operated with reduced performance only if `DeviceLinkThroughputLimit` is set to a value supported by USB 2.0. See [Host setup and bandwidth](#) on page 306. Some pixel formats may not be supported.



#### No image transfer at high bandwidths

USB 2.0 supports maximum 50 MByte/s. If cameras require a higher bandwidth than 50 MByte/s for streaming, no image is transferred on a USB 2.0 bus. The bandwidth used by a camera results from `DeviceLinkThroughputLimit`, the image resolution, sensor characteristics, and pixel format (Mono8 has 8 bits per pixel, while RGB8 has 3 × 8 bits per pixel).

## Handling bare board cameras

Bare board cameras are an electronic assembly without a protective housing. To avoid damage:

- Handle bare board cameras with extreme care.
- Avoid any mechanical stress to the sensor area.
- Avoid short circuits by keeping away from electronics components.

Observe for mounting bare board cameras:

- Allow mechanical contact only at the mounting area. (This does not apply to the cooling area.)
- Enable proper cooling at the cooling area, see [Mounting bare board cameras](#) on page 260.
- Give 2 mm minimum clearance above board components.
- Tighten screws at 0.1 Nm maximum torque.
- Follow the instructions in [Mounting bare board cameras](#) on page 260.

## Optical components

Provide the following conditions to keep dirt and droplets out of the optical system of camera and lens:

- Dust-free environment
- Low relative humidity
- No condensation.

When camera or lens are stored:

- Cover the lens mount with a protection foil or cap.
- Cover front and back lens with caps.



#### Damage to optical components by conductive media for heat sinks

See [Conductive media for heat sinks](#) on page 62 for details.

## Sensor

Sensors are sensitive to excessive radiation: focused sunlight, UV light, lasers, and X-rays can damage the sensor. Dirt and scratches can damage the sensor as well. Alviium USB cameras do not need additional cleaning. Cameras are cleaned before shipping. Incorrect cleaning can damage the sensor or the filter. Therefore, never clean the sensor or the filter.

Protect the camera filter and the sensor from dirt, because dirt becomes more visible the closer it gets to the sensor. In addition, keep the back lens clean. Hold the camera with the lens mount facing the ground to keep dirt out of the lens mount as shown in [Figure 8](#) on page 60.

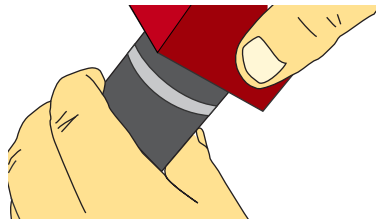

*Figure 8: Holding the camera with the lens mount facing the ground*

When no lens is mounted, protect the sensor and filter by a dust cap.

### Possible damage to image sensors due to electrostatic charge

Generally, bare board cameras and cameras with incomplete housings are very sensitive to electrostatic discharge (ESD) as electronics components are not protected.

In some rare cases, electrostatic charge occurring on the surface of the image sensor may cause damages to particular pixel groups, which may become visible as bubbles or blobs in the image generated by the sensor.

Therefore, it is very important to comply with ESD protection measures in accordance with technical standards.

Follow the instructions in [ESD](#) on page 56.

### Sensor cleanliness

Definitions for Alviium cameras are shown in Table 8:

Sensor family	Aperture*	Visible particles quantity	Max. cluster size	Max. cluster quantity
			Pixels at f1/8.0	At f1/8.0
e2v	f1/4.0	0	30	2
ON Semi	f1/4.0	0	30	2
Sony	f1/8.0	0	0	0

\* The incident beam (not related to the lens' angle of view) is  $\geq 7^\circ$  for f1/8.0 and  $\geq 14^\circ$  for f1/4.0.

*Table 8: Sensor cleanliness definitions*

Alvium cameras are manufactured to match the requirements of typical machine vision applications. This enables a clean image for typical monitor view. Particles may become visible when the image is viewed critically, such as with contrast enhancement or edge detection.



### Advanced sensor cleanliness

If standard definitions for Alvium do not fulfill the requirements of your application, please contact your Allied Vision Sales representative or visit [www.alliedvision.com/en/about-us/contact-us/technical-support-repair/-/rma](http://www.alliedvision.com/en/about-us/contact-us/technical-support-repair/-/rma).

## Lenses

### Maximum protrusion

The sensor, filter, lens, or camera electronics can be damaged if an object (typically a lens) exceeding maximum protrusion is mounted to the camera. Use lenses with a maximum protrusion within camera specifications. Figure 9 shows maximum protrusion. For details, see [Maximum protrusion for front mounts](#) on page 230.

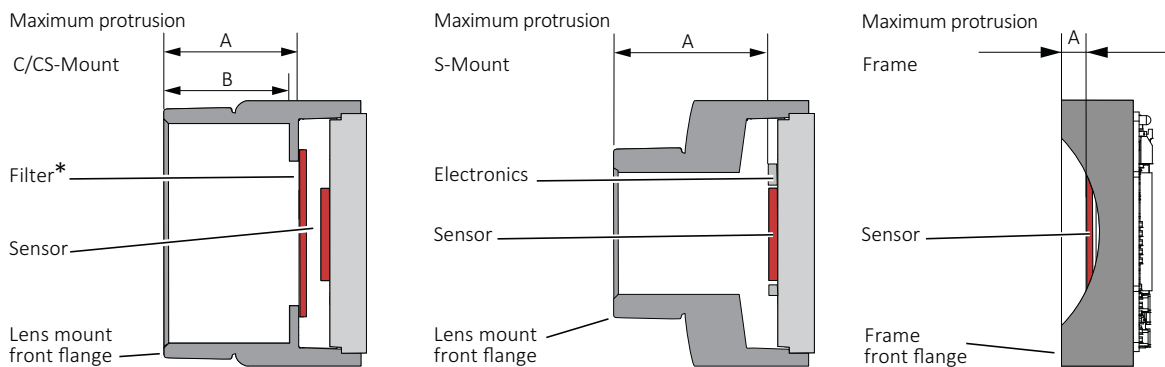

\*Only color models are equipped with an IR cut filter

Figure 9: Maximum protrusion CS-Mount and C-Mount, S-Mount, Frame

For S-Mount lenses, read [Mounting and focusing S-Mount lenses](#) on page 266 to avoid damage to the sensor, the electronics, and lens.

## Mechanical components

### Heat sinks

Heat sinks can be used to cool the camera for safety and to improve image quality. Adhere to the instructions provided by the manufacturer of the heat sink.

## Conductive media for heat sinks

Some conductive media for heat sinks contain corrosive substances that can damage optical surfaces of the sensor, filter, and lens.

- Cover the optical path of the camera when you apply heat sink compound or adhesive to prevent substances and fumes from damaging optical surfaces.
- Adhere to the instructions and safety notes provided by the manufacturer of the conductive media.
- Ensure that the conductive media is correctly positioned: covering only the **cooling area**, see [Mounting the heat sink](#) on page 259.

## BIOS drivers

Sometimes, USB component's firmware must be updated before operation, including devices, such as host adapters cards. To avoid damage and to benefit from possible updates to increase performance: Check for BIOS updates related to USB.

# Specifications



This chapter includes:

Applied standards .....	64
Notes on specifications .....	66
Alvium 1800 U model specifications .....	76
White balance default.....	204
Standard Alvium: Dimensions and mass .....	205
Standard Alvium: Technical drawings .....	207
Alvium Flex: Dimensions and mass.....	222
Alvium Flex: Technical drawings .....	222
Alvium Frame: Dimensions and mass.....	227
Alvium Frame: Technical drawings.....	227
Alvium Frame Flex: Dimensions and mass .....	228
Alvium Frame Flex: Technical drawings .....	229
Maximum protrusion for front mounts .....	230
IR cut filter.....	231
Sensor position accuracy .....	232
User sets.....	235
Camera feature availability .....	236

# Applied standards

## GenICam

GenICam provides a generic access for cameras and devices that is independent of the interface. This enables operating cameras with USB3 Vision, GigE Vision, or CoaXPress interfaces with a common software.

GenICam consists of multiple modules for different tasks. Allied Vision cameras and software use these modules, like the SFNC that standardizes feature names and types via an XML file or the transport layer interface (GenTL) used to grab images.

Alvium 1800 U cameras comply to:

- USB3 Vision Standard Version 1.1
- GenICam Standard Document Version 2.1.1
- GenAPI Schema Version 1.1
- GenAPI Version 3.1
- GenICam Standard Features Naming Convention (SFNC) Version 2.7
- GenICam Pixel Format Naming Convention (PFNC) Version 2.2

## USB3 Vision 1.1

USB3 Vision standard for cameras and imaging products is based on USB 3.0 standard, using USB 3.0 ports. It provides control over compliant devices by GenICam Applications Programming Interface (API). USB3 Vision standard is administered by the Automated Imaging Association (AIA).

## IP class

The following statement applies to closed housing cameras only. Equipped with a lens as intended, the Alvium USB closed housing camera complies with IP30 class according to IEC 60529.

## Shock and vibration

Alvium closed and open housing cameras were tested according to the following standards:

- IEC 60068-2-6, sinusoidal vibration testing
- IEC 60068-2-27, shock testing
- IEC 60068-2-64, random vibration testing.



Cameras were inspected before and after the tests. All tests were passed successfully:

Condition	Passed
Mechanics	<ul style="list-style-type: none"> <li>The camera housings showed no deformations.</li> <li>The connections between camera components had not come loose.</li> <li>The sensor position was within the specified tolerances of a new camera.</li> </ul>
Camera behavior	Camera functionalities were not affected, no deviations occurred.
Image streaming	Images were streamed without errors.

*Table 9: Conditions for passed tests*

The conditions for cameras and lenses were the same for all tests. Solid aluminum tubes were used to represent real lenses:

Parameter	Value
Lens dummy length	38 mm
Lens dummy mass	70 g
Center of gravity (CoG) <sup>1</sup>	20 mm
<sup>1</sup> For camera and lens dummy assemblies, measured from the lens mount front flange	

*Table 10: Conditions for lenses*

## IEC 60068-2-6: Sinusoidal vibration

Frequency	Acceleration	Displacement
10 Hz to 58.1 Hz	Not applicable	1.5 mm
58.1 Hz to 500 Hz	20 g	Not applicable

*Table 11: Frequency, acceleration, and displacement for IEC 60068-2-6 tests*

Parameter	Value
Axis	x, y, z
Sweep rate	1 oct/min
Sweep duration per axis [hh:mm:ss]	00:11:17
Number of sweeps	20

*Table 12: Other parameters for IEC 60068-2-6 tests*

## IEC 60068-2-27: Shock

Parameter	Value
Axis	x, y, z
Acceleration	20 g
Number of shocks per axis	10
Duration per axis	11 ms
Waveform	Half sine

Table 13: Parameters for IEC 60068-2-27 tests

## IEC 60068-2-64: Random vibration

Frequency	Acceleration
15 Hz to 500 Hz	0.05 g <sup>2</sup> /Hz

Table 14: Frequency and acceleration for IEC 60068-2-64 tests

Parameter	Value
Axis	x, y, z
Acceleration RMS (Sigma)	4.9 g
Acceleration peak (Sigma)	14.8 g
Duration per axis [hh:mm:ss]	00:30:00

Table 15: Other parameters for IEC 60068-2-64 tests

# Notes on specifications

This section defines the conditions for specifications stated in this chapter.

## Sensor

### Absolute QE plots

Measurements for color cameras were done with IR cut filter, measurements for monochrome and S-Mount cameras were done without optical filters. With optical filters, QE decreases by approximately 10 percent. The uncertainty in measurement of the QE values is  $\pm 10$  percent. This is mainly due to uncertainties in the measuring apparatus itself (such as Ulbricht sphere and optometer).

Manufacturing tolerance of the sensor increases overall uncertainty.

### ON Semiconductor sensors

The curve in the absolute QE plots shown in this chapter is from the sensor manufacturer data sheet. The information was correct at the time of publishing.

### Sony sensors

Sony provides relative response curves in their sensor data sheets. To create the absolute QE plots shown in this chapter, the relative response was converted to a normalized QE response and then adjusted as per three measured QE values (at 448 nm, 529 nm, 632 nm) for color sensors and one measured QE value (at 529 nm) for monochrome sensors.

### Wavelength

The wavelength range in the absolute QE plots reflects the information available in the sensor manufacturer data sheet at the time of publishing. For additional wavelength information, contact the sensor manufacturer.

### Spectral response plots

The curves in the spectral response plots shown in this chapter were calculated from measured quantum efficiencies at 448 nm, 529 nm, and 632 nm. The shape of the curve is taken from the sensor data sheet but the values have been adjusted based on these measured values. The uncertainty in measurement of the spectral response values is  $\pm 10$  percent.

## Exposure time and frame rates

### Specified values

Stated values were calculated (see [Operation for maximum frame rates](#)), then verified with the test setup described in [Table 16](#).

**Deviations from stated frame rates** can occur, especially when:

- The camera is operated in triggered mode
- Low bandwidth is used
- Small ROIs are used.

Component	Property
Desktop workstation	Dell Precision T5500 Precision (EHW400)
Chipset	Intel X5520
CPU	Intel Xeon X5670 (6 cores)
CPU frequency	2.93 GHz
RAM	12 GB

*Table 16: Test setup components*

Component	Property
Graphics controller	NVIDIA Quadro FX 580
USB controller	Delock U3 PCIe 1XG205-1S Rev. 1.1 (2-port USB 3.0 to PCI Express x1 Gen 2 with Renesas chipset)
Operating system	Windows 7 Ultimate 64-bit SP1
Measured by	Oscilloscope
Measured signal	<i>ExposureActive</i>

Table 16: Test setup components

## Factors for exposure time and frame rates

- The **default bandwidth** for Alvium USB cameras is 200 MByte/s. For some models, you can achieve higher frame rates by increasing values for **MaxTransferSize** and **DeviceLinkThroughputLimit**. See [Host setup and bandwidth](#) on page 306.
- Available values and increments for **exposure time** depend on other controls, such as **DeviceLinkThroughputLimit**. See [Value changes by feature interdependencies](#) on page 301.
- For **delays**, see [Exposure start delay = exposure area – exposure time.](#) on page 289.
- Calculation of maximum **frame rates for different ROIs** for Alvium USB cameras does not allow to give a formula. [Operation for maximum frame rates](#) on page 69 defines the conditions for measuring ROI frame rates.

## Sensor ADC readout modes for maximum frame rates

If you are using pixel formats that do not require 12-bit sensor ADC readout and you want to achieve higher frame rates, you can select between readout modes for 12-bit, 10-bit, and 8-bit with some Alvium USB camera models. See your model's specifications.

By default, Alvium 1800 U models use the maximum bit depth for **SensorBitDepth**. For selected models, *Adaptive* mode switches automatically between 12-bit and 10-bit sensor ADC readout, depending on the bit depth of the selected pixel format. This allows to reduce bandwidth and increase frame rates when only 10-bit is required.

To enable the 8-bit sensor readout mode, you must switch manually, using **SensorBitDepth**. Please observe that the image brightness changes when you switch between 8-bit sensor ADC readout mode and the other readout modes.

Keep in mind that changing the output bit depth of the sensor also affects the minimum available exposure time of the camera.



### Maximum frame rates at different values for SensorBitDepth

When the maximum bandwidth supported by USB interface is reached, reducing the value for **SensorBitDepth** does not increase the available maximum frame rate.

## Exposure time behavior regarding ExposureMode

This section informs about how exposure time behaves in the different exposure modes.

All Alvim cameras have an exposure time offset. The exposure time offset and the exposure time increment depend on sensor and camera characteristics. Both, the exposure time offset and the exposure time increment, can change if **Width**, **PixelFormat**, or **DeviceLinkThroughputLimit** are changed. See [Value changes by feature interdependencies](#) on page 301.

### ExposureMode = Timed

For all Alvim cameras, exposure time can be set by **ExposureTime** or **ExposureAuto**. For this, **ExposureMode** is set to *Timed*.

The selected exposure time is extended automatically:

- If the selected exposure time does not match the available increment, the camera automatically extends the exposure time to the next increment.
- The **exposure time offset is included** in the selected exposure time.

### ExposureMode = TriggerWidth or TriggerControlled

In addition, most global shutter (GS) cameras can control exposure time by the trigger signal, with the **ExposureMode** set to *TriggerWidth* or *TriggerControlled* (using **ExposureStart** and **ExposureStop**).

The trigger controlled exposure time is extended automatically:

- If the trigger controlled exposure time does not match the available increment, the camera automatically extends the exposure time to the next increment.
- Subsequently, the **exposure time offset is added**.

You can use **ExposureActive** to determine the duration of the exposure time offset.

## Operation for maximum frame rates

Values for maximum frame rates and for minimum and maximum exposure time in the specification tables are based on following parameters:

- Factory settings (camera after power up)
- Minimum exposure time
- Full resolution
- Mono8 pixel format or 8-Bit Bayer pixel format
- Camera operation in freerun mode
- Minimum value for **SensorBitDepth** (8-bit sensor ADC readout mode if available)
- Bandwidth required for the corresponding frame rate, as stated in the tables for ROI frame rates.

**Bandwidth:** Data is provided for 200 MByte/s, 375 MByte/s, and 450 MByte/s, using 8-bit, 10-bit, and 12-bit sensor ADC readout modes, depending on model abilities. The default value for `DeviceLinkThroughputLimit` is 200 MByte/s for Alvim 1800 U cameras measured as average sensor readout.

## Frame rates with rolling shutter sensors

The following table shows how the shutter mode impacts available frame rates. Reducing the area for ROI reduces readout time. The values in [Table 17](#) apply only if exposure time is shorter than readout time.

Sensor type	Shutter mode	Trigger mode	Frame rates at full resolution*	ROI frame rates
All models, except for...	Global shutter (GS)	Freerun	100%	Increased values
	Global shutter (GS)	External trigger	100%	
1800 U-500, -501 NIR	Rolling shutter (RS)	Freerun	100%	Increased values
	Rolling shutter (RS)	External trigger	>50%	
1800 U-1240	Rolling shutter (RS)	Freerun	100%	<b>No increase</b>
	Rolling shutter (RS)	External trigger	>99%	
	Global reset shutter (GRS)	Freerun	>99%	
	Global reset shutter (GRS)	External trigger	>99%	
1800 U-2050	Rolling shutter (RS)	Freerun	100%	Increased values
	Rolling shutter (RS)	External trigger	>99%	
	Global reset shutter (GRS)	Freerun	>99%	
	Global reset shutter (GRS)	External trigger	>99%	

\*Related to the values for maximum frame rates stated in the specification tables for each model.

Table 17: Frame rates depending on shutter and trigger modes



### Achieved frame rates may not match specified values

- Some sensors have an exposure start jitter that may reduce maximum frame rates.
- Your individual setup may cause delays in data transmission.



### Bandwidth adjustments

Consider the bandwidth available for camera payload depends on your individual hardware, the operating system, software and drivers, and your application. We recommend you to adjust `DeviceLinkThroughputLimit` and `MaxTransferSize` to your requirements. See [Host setup and bandwidth](#) on page 306.



### Interdependencies between ROI and ExposureTime values

Changing parameters for ROI can affect values for `ExposureTime`, such as minimum, maximum, and increments, but `ExposureTime` itself as well. We recommend you to set:

- ROI values
- `DeviceLinkThroughputLimit`

before you set values for `ExposureTime`.

See [Value changes by feature interdependencies](#) on page 301 for details.

`MaxTransferSize` can have an impact as well.

## Sensor shutter types

Differences between global shutter (GS), rolling shutter (RS), and global reset shutter (GRS) sensors are explained in [Shutter types affecting image readout](#) on page 305. Triggering behavior differs between cameras with global shutter (GS) and rolling shutter (RS). See [Triggering and timings](#) on page 287 for details.

## Brightness with 1800 U-812 UV cameras

When the sensor is exposed to light above 400 nm wavelength, the PLS (parasitic light sensitivity) effect occurs: The brightness level increases from the bottom to the top of the image.

## Digital binning

Alvium USB cameras combine digital horizontal binning and digital vertical binning, for integer values 1 to 8.



### Alvium models $\geq 12$ MP resolution

If digital horizontal and digital vertical binning are set to 1x and the digital vertical binning value is increased, digital horizontal binning is automatically set to 2x.

## Sensor binning

Selected camera models support sensor binning in addition to digital binning. From these models, all support *Sum* for binning, some also support *Average*.

See the specifications tables in [Alvium 1800 U model specifications](#) on page 76.



### Please observe

- Only digital binning or sensor binning can be used at a time.
- You must revert binning values to **1** before you can switch between these binning modes.

## Multiple regions

All Alvium 1800 U models support single ROI (region of interest). Because multiple ROI (**MultipleRegions** features) are sensor based, it is not supported by all camera models. With all the corresponding models, *Free* mode is available for **MultipleRegionArrangement** with 1 to 4 subregions. Other models also support *Tile* mode, some models also support *Horizontal* and *Vertical* mode with 1 to 4 subregions. See [Table 18](#).





Mode	Sensor input	Camera output
<i>Free</i>		
<i>Tile</i>		
<i>Horizontal</i>		
<i>Vertical</i>		

Table 18: Modes for MultipleRegions

See the specifications tables in [Alvium 1800 U model specifications](#) on page 76 for **MultipleRegionArrangement** options and [Available subregion resolutions](#) on page 73.

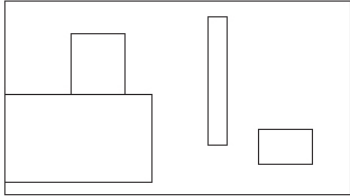

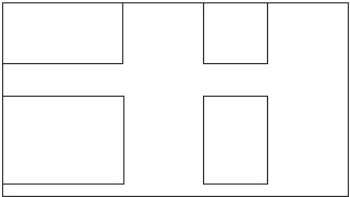
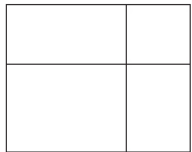
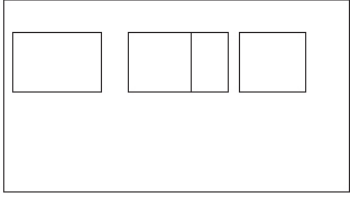
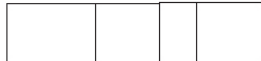
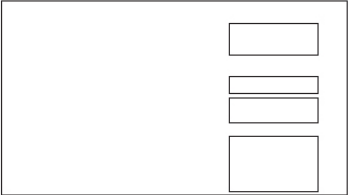
### Using multiple regions

Alvium Features Reference: [www.alliedvision.com/en/support/technical-documentation/alvium-usb-documentation](http://www.alliedvision.com/en/support/technical-documentation/alvium-usb-documentation).



## Available subregion resolutions

Table 19 shows the available total pixel resolutions when multiple regions are enabled. How are these values applied?

Alvium 1800 U-2460 supports 1 to 4 subregions in *Horizontal* mode.

### Example

Subregions could be  $608 \times 8$ ,  $608 \times 8$ ,  $2048 \times 8$ , and  $1920 \times 8$ , with a minimum width of 608 pixels per subregion and a minimum height of 8 pixels.



### Minimum width for subregions

We are working on a future solution to enable smaller width values.

The same working principle applies to *Vertical* mode correspondingly.

Alvium model	Sensor	Minimum subregion	Maximum subregion
1800 U-030 VSWIR	IMX991	$8 \times 8$	$656 \times 520$
1800 U-040	IMX287	$260 \times 4$	$728 \times 544$
1800 U-050	PYTHON 480	Not supported	
1800 U-052	IMX426	Not supported	
1800 U-120	AR0135	Not supported	
1800 U-130 VSWIR	IMX990	$8 \times 8$	$1296 \times 1032$
1800 U-131	EV76C560	Not supported	
1800 U-158	IMX273	$260 \times 4$	$1456 \times 1088$
1800 U-192	EV76C570	Not supported	
1800 U-203	IMX422	$16 \times 8$	$1632 \times 1248$
1800 U-234	IMX249	$92 \times 2$	$1936 \times 1216$
1800 U-235	IMX17	$92 \times 2$	$1936 \times 1216$
1800 U-240	IMX392	$260 \times 4$	$1936 \times 1216$
1800 U-291	IMX421	$16 \times 8$	$1944 \times 1472$
1800 U-319	IMX265	$260 \times 4$	$2064 \times 1544$
1800 U-320 VSWIR	IMX993	$16 \times 8$	$2080 \times 1544$
1800 U-500	AR0521	Not supported	
1800 U-501 NIR	AR0522	Not supported	
1800 U-507 <sup>1</sup>	IMX264	$260 \times 4$	$2464 \times 2056$

Table 19: Available subregion resolutions (sheet 1 of 2)

Alvium model	Sensor	Minimum subregion	Maximum subregion
1800 U-508 <sup>1</sup>	IMX250	260 × 4	2464 × 2056
<sup>1</sup> Including Pol models			
1800 U-510	IMX548	608 × 8	2464 × 2064
1800 U-511	IMX547	608 × 8	2464 × 2064
1800 U-530 VSWIR	IMX992	16 × 8	2592 × 2056
1800 U-811	IMX546	608 × 8	2848 × 2848
1800 U-812 UV	IMX487	608 × 16	2848 × 2848
1800 U-895	IMX267	260 × 4	4112 × 2176
1800 U-1236	IMX304	260 × 4	4112 × 3008
1800 U-1240	IMX226	Not supported	
1800 U-1242	IMX545	608 × 8	4128 × 3008
1800 U-1620	IMX542	608 × 8	5328 × 3040
1800 U-2040	IMX541	608 × 8	4512 × 4512
1800 U-2050	IMX183	Not supported	
1800 U-2460	IMX540	608 × 8	5328 × 4608

Table 19: Available subregion resolutions (sheet 2 of 2)

## Operation for medium power consumption

Values for power consumption in the specification tables are based on following parameters:

- Factory settings (camera after power up)
- Minimum exposure time
- Maximum frame rate
- Full resolution
- Mono8 pixel format or 8-Bit Bayer pixel format
- Camera operation in freerun mode
- Sensor ADC readout using maximum bit depth
- Without bandwidth limitations.

## Dimensions and mass

For your model's dimensions, see [Standard Alvium: Dimensions and mass](#) on page 205.

In manufacturing, camera board and sensor are moved against each other to adjust flange focal distance. The value range for camera length with open housing

cameras reflects in the technical drawings. See [Standard Alvium: Technical drawings](#) on page 207.

# Alvium 1800 U model specifications

## Alvium 1800 U-030 VSWIR

Feature	Specification
	<b>1800 U-030 VSWIR</b>
Sensor model	Sony IMX991
Resolution	656 (H) × 520 (V); 0.3 MP
Sensor type	InGaAs
Shutter type	Global shutter (GS)
Sensor size	Type 1/4; 3.3 mm × 2.6 mm; 4.1 mm diagonal
Pixel size	5 μm × 5 μm
CRA	0 deg
Sensor bit depth (ADC)	8-bit, 10-bit, 12-bit; Adaptive (10-bit, 12-bit)
Monochrome pixel formats	Mono8 (default), Mono10, Mono10p, Mono12, Mono12p
Maximum frame rate	249 fps (at ≥200 MByte/s)
Exposure time	15 μs to 10 s (200 MByte/s)
Exposure modes	Timed, TriggerControlled, TriggerWidth
Gain	0 dB to 42 dB; 0.1 dB increments
Digital binning	Horizontal: 1 to 8 columns; Vertical: 1 to 8 rows
Multiple ROI (H × V)	<i>Free   Tile   Horizontal: 1 × 1 to 1 × 4   Vertical: 1 × 1 to 4 × 1</i>
Image buffer (RAM)	256 KByte
Non-volatile memory (Flash)	1024 KByte
GPIOs	4 programmable GPIOs As direct inputs (push-pull): 0 to 5.5 VDC As direct outputs (push-pull): 0 to 3.3 VDC at 12 mA
Power requirements	Power over USB; External power
Power consumption (typical, at 5 VDC)	USB power: 2.0 W External power: 2.2 W

Table 20: Alvium 1800 U-030 VSWIR specifications (sheet 1 of 2)

Feature	Specification			
	<b>1800 U-030 VSWIR</b>			
Storage temperature	-20 °C to +85 °C ambient temperature			
<b>Operating temperature</b>	<b>Hardware option</b>	<b>Housing</b>	<b>Cooling area<sup>1</sup></b>	<b>Mainboard<sup>2</sup></b>
	Bare board <sup>3</sup>	Not applicable	-20 °C to +85 °C	-20 °C to +85 °C
	Open housing <sup>4</sup>	-20 °C to +65 °C		
	Closed housing	-20 °C to +65 °C	Not applicable	
Relative humidity	0% to 80% (non-condensing)			
Digital interface	Micro-B USB 3.1 Gen 1 interface			
Camera controls	GenICam (GenICam Access)			

<sup>1</sup> See [Mounting the heat sink](#) on page 259.

<sup>2</sup> Output by DeviceTemperature

<sup>3</sup> Ensure that the sensor is operated in the temperature range specified by the manufacturer. For any questions, please visit [www.alliedvision.com/en/support](http://www.alliedvision.com/en/support).

<sup>4</sup> Temperature values must be observed for the housing **and** for the cooling area.

Table 20: Alvium 1800 U-030 VSWIR specifications (sheet 2 of 2)

### Absolute QE

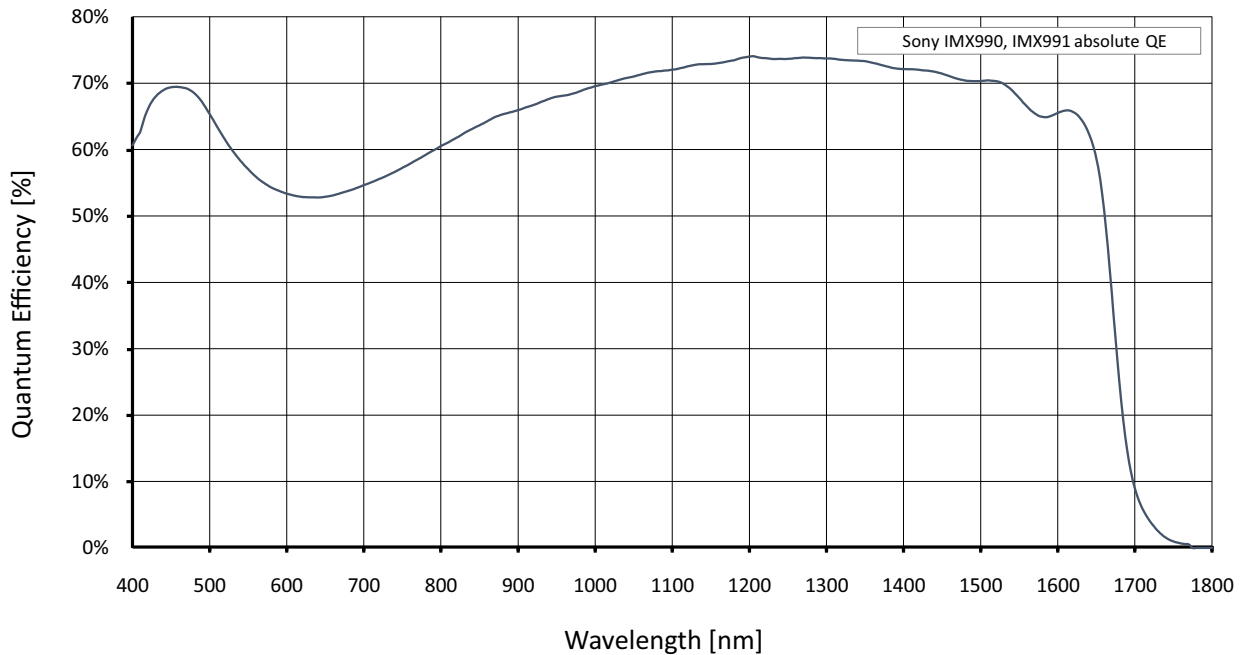

Figure 10: Alvium 1800 U-030 VSWIR (Sony IMX991) absolute QE

## ROI frame rates

Values were measured as defined in [Specified values](#) on page 67.

To reach the maximum frame rate available for this setup, the bandwidth for image traffic is 200 MByte/s. Increasing the `DeviceLinkThroughputLimit` value does not increase frame rates.

Image format	Width [pixels]	Height [pixels]	ROI area [MP]	Frame rate [fps] <sup>1</sup>		
				450 MByte/s	375 MByte/s	200 MByte/s
Full resolution	656	520	0.341	249.2/231.0/133.0		
VGA	640	480	0.307	267.9/248.3/143.0		
HVGA	480	320	0.154	384.9/356.4/205.2		
QVGA	320	240	0.077	494.1/457.2/262.7		
HQVGA	240	160	0.038	683.2/634.4/365.0		
QQVGA	160	120	0.019	849.9/789.2/454.6		
Max. × half	656	260	0.171	450.4/416.9/241.0		
Max. × min.	656	8	0.005	2340.8/2138.5/1286.8		
Min. × max.	8	520	0.004	252.3/234.3/134.1		
Min. × min.	8	8	64 P	2644.2/2455.3/1405.9		

<sup>1</sup> Mono8 at `SensorBitDepth` = 8-Bit<sup>(2)</sup> / Mono10 at `SensorBitDepth` = 10-Bit / Mono12 or at `SensorBitDepth` = 12-Bit

<sup>2</sup> The `SensorBitDepth` value must be set separately from `PixelFormat`. See [Sensor ADC readout modes for maximum frame rates](#) on page 68 for details.

Table 21: Alvium 1800 U-030 VSWIR ROI frame rates

## Alvium 1800 U-040m/c

Feature	Specification	
	1800 U-040m (monochrome)	1800 U-040c (color)
Sensor model	Sony IMX287	
Resolution	728 (H) × 544 (V); 0.4 MP	
Sensor type	CMOS	
Shutter type	Global shutter (GS)	
Sensor size	Type 1/2.9; 5.0 mm × 3.8 mm; 6.3 mm diagonal	
Pixel size	6.9 μm × 6.9 μm	
CRA	0 deg	
Sensor bit depth (ADC)	8-bit, 10-bit, 12-bit; Adaptive (10-bit, 12-bit)	
Monochrome pixel formats	Mono8 (default), Mono10, Mono10p, Mono12, Mono12p	Mono8, Mono10, Mono10p, Mono12, Mono12p
YUV color pixel formats	Not applicable	YCbCr411_8_CbYYCrYY, YCbCr422_8_CbYCrY, YCbCr8_CbYCr
RGB color pixel formats	Not applicable	BGR8, RGB8 (default)
Raw color pixel formats	Not applicable	BayerRG8, BayerRG10, BayerRG10p, BayerRG12, BayerRG12p
Maximum frame rate	494 fps (at ≥375 MByte/s)	
Exposure time	20 μs to 10 s (375 MByte/s)	
Exposure modes	Timed, TriggerControlled, TriggerWidth	
Gain	0 dB to 48 dB; 0.1 dB increments	
Digital binning	Horizontal: 1 to 8 columns; Vertical: 1 to 8 rows	
Multiple ROI (H × V)	<i>Free</i>	
Image buffer (RAM)	256 KByte	
Non-volatile memory (Flash)	1024 KByte	
GPIOs	4 programmable GPIOs As direct inputs (push-pull): 0 to 5.5 VDC As direct outputs (push-pull): 0 to 3.3 VDC at 12 mA	
Power requirements	Power over USB; External power	
Power consumption (typical, at 5 VDC)	USB power: 1.9 W External power: 2.1 W	

Table 22: Alvium 1800 U-040m/c specifications (sheet 1 of 2)

Feature	Specification			
	<b>1800 U-040m/c</b>			
Storage temperature	-20 °C to +85 °C ambient temperature			
<b>Operating temperature</b>	<b>Hardware option</b>	<b>Housing</b>	<b>Cooling area<sup>1</sup></b>	<b>Mainboard<sup>2</sup></b>
	Bare board <sup>3</sup>	Not applicable	-20 °C to +85 °C	-20 °C to +85 °C
	Open housing <sup>4</sup>	-20 °C to +65 °C		
	Closed housing	-20 °C to +65 °C	Not applicable	
Relative humidity	0% to 80% (non-condensing)			
Digital interface	Micro-B USB 3.1 Gen 1 interface			
Camera controls	GenICam (GenICam Access)			

<sup>1</sup> See [Mounting the heat sink](#) on page 259.

<sup>2</sup> Output by DeviceTemperature

<sup>3</sup> Ensure that the sensor is operated in the temperature range specified by the manufacturer. For any questions, please visit [www.alliedvision.com/en/support](http://www.alliedvision.com/en/support).

<sup>4</sup> Temperature values must be observed for the housing **and** for the cooling area.

Table 22: Alvium 1800 U-040m/c specifications (sheet 2 of 2)



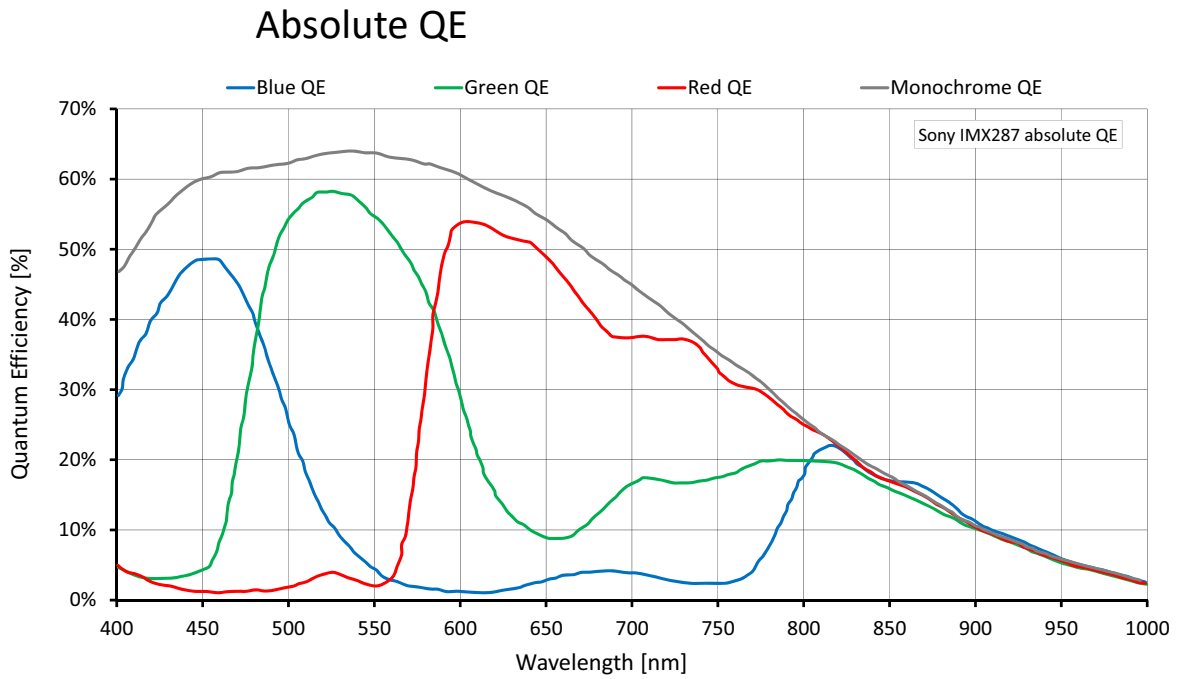

Figure 11: Alvim 1800 U-040m/c (Sony IMX287) absolute QE

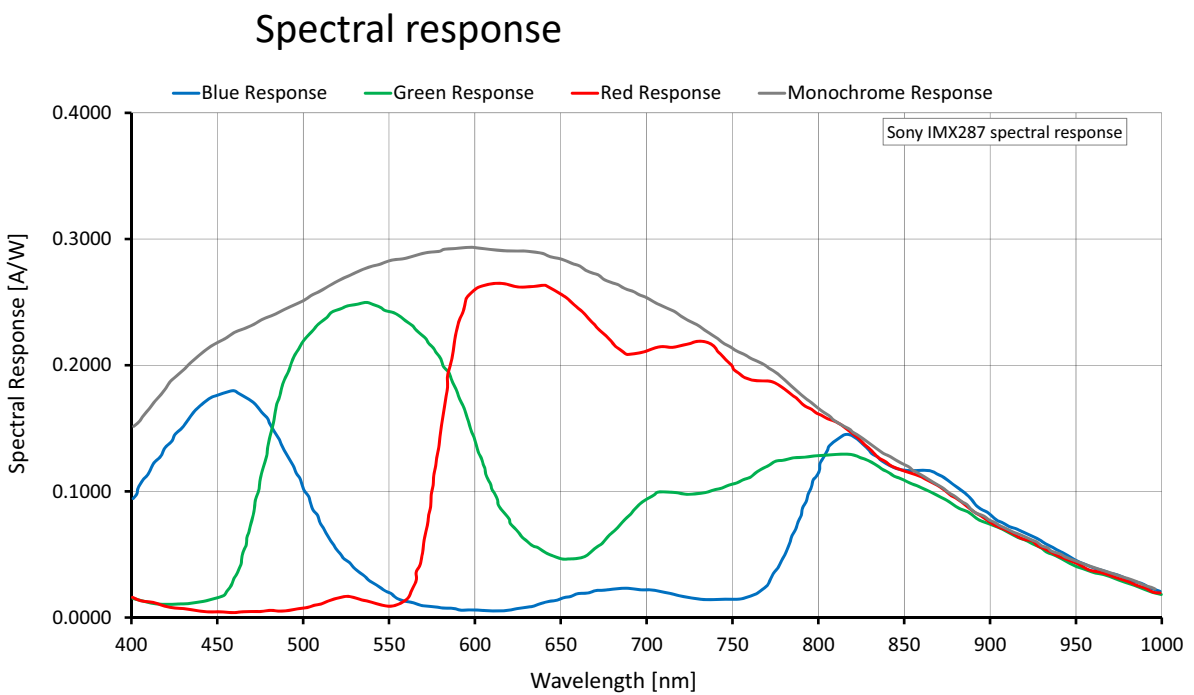

Figure 12: Alvim 1800 U-040m/c (Sony IMX287) spectral response

## ROI frame rates

Values were measured as defined in [Specified values](#) on page 67.

To reach the maximum frame rate available for this setup, the bandwidth for image traffic is 375 MByte/s. Increasing the `DeviceLinkThroughputLimit` value does not increase frame rates.

Image format	Width [pixels]	Height [pixels]	ROI area [MP]	Frame rate [fps] <sup>1</sup>		
				450 MByte/s	375 MByte/s	200 MByte/s
Full resolution	728	544	0.396	494.0/409.3/302.3		445.3/227.3/224.0
VGA	640	480	0.307	553.3/458.5/338.9		553.3/288.9/284.9
HVGA	480	320	0.154	786.3/652.1/483.5		786.3/539.9/483.5
QVGA	320	240	0.077	991.2/833.4/617.7		
HQVGA	240	160	0.038	1340.5/1138.9/847.2		
QQVGA	160	120	0.019	1627.3/1390.6/1037.6		
Max. × half	728	272	0.198	884.6/733.8/544.8		800.5/412.9/405.9
Max. × min.	728	8	0.006	3803.8/3186.0/2462.7		3545.1/1992.7/1915.3
Min. × max.	8	544	0.004	498.0/416.0/306.8		
Min. × min.	8	8	64 P	4057.3/3647.7/2798.5		

<sup>1</sup> Mono8 or Bayer...8<sup>(2)</sup> at `SensorBitDepth` = 8-Bit<sup>(3)</sup> / Mono10 or Bayer...10 at `SensorBitDepth` = 10-Bit / Mono12 or Bayer...12 at `SensorBitDepth` = 12-Bit

<sup>2</sup> The three dots... represent the colors of a Bayer pixel format, such as in BayerRG8.

<sup>3</sup> The `SensorBitDepth` value must be set separately from `PixelFormat`. See [Sensor ADC readout modes for maximum frame rates](#) on page 68 for details.

Table 23: Alvium 1800 U-040m/c ROI frame rates

## Alvium 1800 U-050m/c



### Supported firmware version

Alvium 1800 U-050 models are delivered with firmware 00.11.00.9cf0c21e. The firmware version cannot be updated to later versions.

Feature	Specification	
	1800 U-050m (monochrome)	1800 U-050c (color)
Sensor model	ON Semiconductor PYTHON 480	
Resolution	808 (H) × 608 (V); 0.5 MP	
Sensor type	CMOS	
Shutter type	Global shutter (GS)	
Sensor size	Type 1/3.6; 3.9 mm × 2.9 mm; 4.9 mm diagonal	
Pixel size	4.8 μm × 4.8 μm	
CRA	1.65 deg	
Sensor bit depth (ADC)	10-bit	
Monochrome pixel formats	Mono8 (default), Mono10, Mono10p, Mono12, Mono12p	Mono8, Mono10, Mono10p, Mono12, Mono12p
YUV color pixel formats	Not applicable	YCbCr411_8_CbYYCrYY, YCbCr422_8_CbYCrY, YCbCr8_CbYCr
RGB color pixel formats	Not applicable	BGR8, RGB8 (default)
Raw color pixel formats	Not applicable	BayerRG8, BayerRG10, BayerRG10p, BayerGR12, BayerGR12p
Maximum frame rate	117 fps (at ≥200 MByte/s)	
Exposure time	64 μs to 10 s (200 MByte/s)	
Exposure modes	Timed, TriggerControlled, TriggerWidth	
Gain	0 dB to 11.3 dB; 0.1 dB increments	
Digital binning	Horizontal: 1 to 8 columns; Vertical: 1 to 8 rows	
Image buffer (RAM)	256 KByte	
Non-volatile memory (Flash)	1024 KByte	
GPIOs	4 programmable GPIOs As direct inputs (push-pull): 0 to 5.5 VDC As direct outputs (push-pull): 0 to 3.3 VDC at 12 mA	
Power requirements	Power over USB; External power	
Power consumption (typical, at 5 VDC)	USB power: 1.5 W External power: 1.7 W	

Table 24: Alvium 1800 U-050m/c specifications (sheet 1 of 2)

Feature	Specification			
	<b>1800 U-050m/c</b>			
Storage temperature	-20 °C to +85 °C ambient temperature			
<b>Operating temperature</b>	<b>Hardware option</b>	<b>Housing</b>	<b>Cooling area<sup>1</sup></b>	<b>Mainboard<sup>2</sup></b>
	Bare board <sup>3</sup>	Not applicable	-20 °C to +85 °C	-20 °C to +85 °C
	Open housing <sup>4</sup>	-20 °C to +65 °C		
	Closed housing	-20 °C to +65 °C	Not applicable	
Relative humidity	0% to 80% (non-condensing)			
Digital interface	Micro-B USB 3.1 Gen 1 interface			
Camera controls	GenICam (GenICam Access)			
<sup>1</sup> See <a href="#">Mounting the heat sink</a> on page 259. <sup>2</sup> Output by <code>DeviceTemperature</code> <sup>3</sup> Ensure that the sensor is operated in the temperature range specified by the manufacturer. For any questions, please visit <a href="http://www.alliedvision.com/en/support">www.alliedvision.com/en/support</a> . <sup>4</sup> Temperature values must be observed for the housing <b>and</b> for the cooling area.				

*Table 24: Alvium 1800 U-050m/c specifications (sheet 2 of 2)*

### Absolute QE

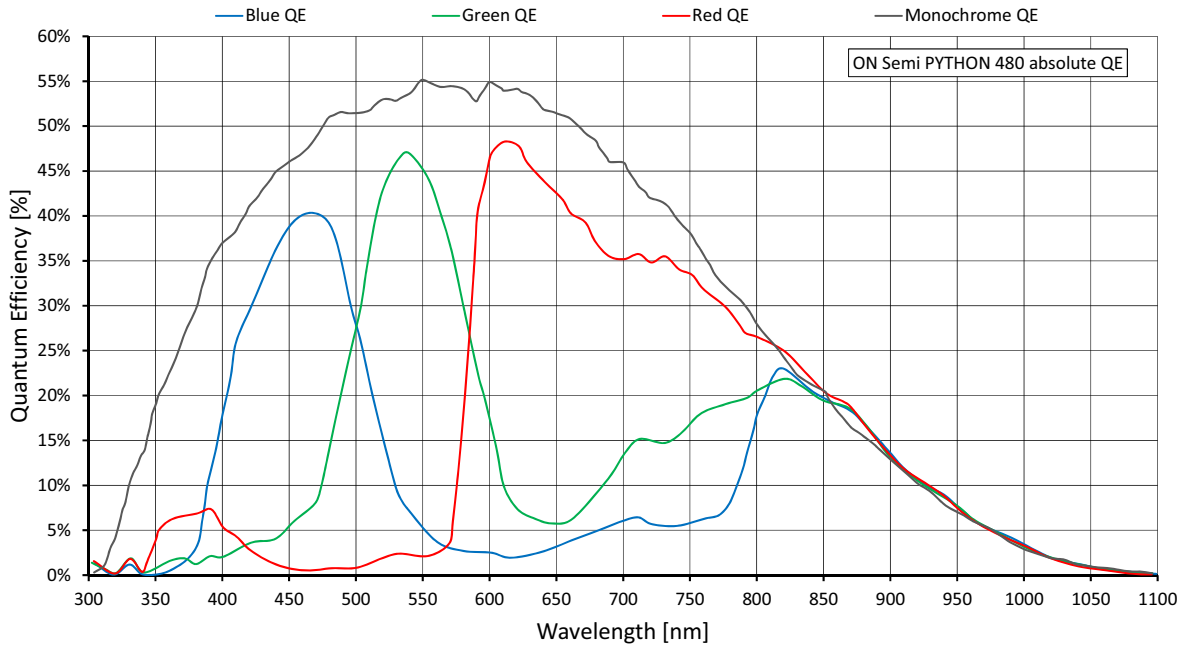

Figure 13: Alvium 1800 U-050m/c (ON Semi PYTHON 480) absolute QE

### Spectral response

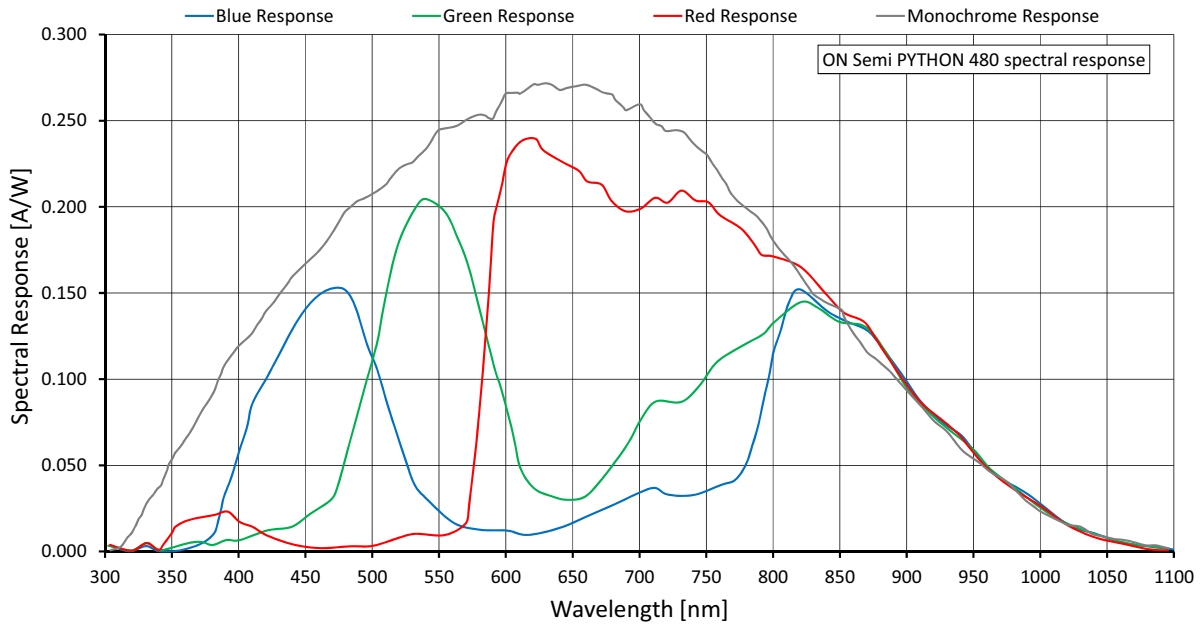

Figure 14: Alvium 1800 U-050m/c (ON Semi PYTHON 480) spectral response

## ROI frame rates

Values were measured as defined in [Specified values](#) on page 67.

To reach the maximum frame rate available for this setup, the bandwidth for image traffic is 200 MByte/s. Increasing the `DeviceLinkThroughputLimit` value does not increase frame rates.

Image format	Width [pixels]	Height [pixels]	ROI area [MP]	Frame rate [fps] <sup>1</sup>		
				450 MByte/s	375 MByte/s	200 MByte/s
Full resolution	808	608	0.491	117.2/117.2		
SVGA	800	600	0.480	119.7/119.7		
VGA	640	480	0.307	177.0/177.0		
HVGA	480	320	0.154	314.7/314.7		
QVGA	320	240	0.077	517.2/517.2		
HQVGA	240	160	0.038	792.0/792.0		
QQVGA	160	120	0.019	1083.1/1083.1		
Max. × half	808	304	0.246	220.0/220.0		
Max. × min.	808	8	0.006	1501.7/1501.7		
Min. × max.	8	608	0.005	732.7/732.7		
Min. × min.	8	8	64 P	2035.8/2035.8		

<sup>1</sup> Mono8 or Bayer...8<sup>(2)</sup> at `SensorBitDepth` = 10-Bit / Mono10 or Bayer...10 at `SensorBitDepth` = 10-Bit

<sup>2</sup> The three dots... represent the colors of a Bayer pixel format, such as in Bayer**RG8**.

Table 25: Alvim 1800 U-050m/c ROI frame rates

## Alvium 1800 U-052m/c

Feature	Specification	
	1800 U-052m (monochrome)	1800 U-052c (color)
Sensor model	Sony IMX426	
Resolution	816 (H) × 624 (V); 0.5 MP	
Sensor type	CMOS	
Shutter type	Global shutter (GS)	
Sensor size	Type 1/1.7; 7.3 mm × 5.6 mm; 9.2 mm diagonal	
Pixel size	9.0 μm × 9.0 μm	
CRA	0 deg	
Sensor bit depth (ADC)	8-bit, 10-bit, 12-bit; Adaptive (10-bit, 12-bit)	
Monochrome pixel formats	Mono8 (default), Mono10, Mono10p, Mono12, Mono12p	Mono8, Mono10, Mono10p, Mono12, Mono12p
YUV color pixel formats	Not applicable	YCbCr411_8_CbYYCrYY, YCbCr422_8_CbYCrY, YCbCr8_CbYCr
RGB color pixel formats	Not applicable	BGR8, RGB8 (default)
Raw color pixel formats	Not applicable	BayerRG8, BayerRG10, BayerRG10p, BayerRG12, BayerRG12p
Maximum frame rate	688 fps (at 450 MByte/s)	
Exposure time	24 μs to 10 s (450 MByte/s)	
Exposure modes	Timed, TriggerControlled, TriggerWidth	
Gain	0 dB to 48 dB; 0.1 dB increments	
Digital binning	Horizontal: 1 to 8 columns; Vertical: 1 to 8 rows	
Multiple ROI (H × V)	<b>Free   Tile   Horizontal:</b> 1 × 1 to 1 × 4   <b>Vertical:</b> 1 × 1 to 4 × 1	
Image buffer (RAM)	256 KByte	
Non-volatile memory (Flash)	1024 KByte	
GPIOs	4 programmable GPIOs As direct inputs (push-pull): 0 to 5.5 VDC As direct outputs (push-pull): 0 to 3.3 VDC at 12 mA	
Power requirements	Power over USB; External power	
Power consumption (typical, at 5 VDC)	USB power: 4.0 W External power: 4.2 W	

Table 26: Alvium 1800 U-052m/c specifications (sheet 1 of 2)

Feature	Specification			
	<b>1800 U-052m/c</b>			
Storage temperature	-20 °C to +85 °C ambient temperature			
<b>Operating temperature</b>	<b>Hardware option</b>	<b>Housing</b>	<b>Cooling area<sup>1</sup></b>	<b>Mainboard<sup>2</sup></b>
	Bare board <sup>3</sup>	Not applicable	-20 °C to +85 °C	-20 °C to +85 °C
	Open housing <sup>4</sup>	-20 °C to +65 °C		
	Closed housing	-20 °C to +65 °C	Not applicable	
Relative humidity	0% to 80% (non-condensing)			
Digital interface	Micro-B USB 3.1 Gen 1 interface			
Camera controls	GenICam (GenICam Access)			

<sup>1</sup> See [Mounting the heat sink](#) on page 259.

<sup>2</sup> Output by DeviceTemperature

<sup>3</sup> Ensure that the sensor is operated in the temperature range specified by the manufacturer. For any questions, please visit [www.alliedvision.com/en/support](http://www.alliedvision.com/en/support).

<sup>4</sup> Temperature values must be observed for the housing **and** for the cooling area.

Table 26: Alvium 1800 U-052m/c specifications (sheet 2 of 2)



## Absolute QE, spectral response

We intend to add diagrams in a future version of this document.

## ROI frame rates

Values were measured as defined in [Specified values](#) on page 67.

To reach the maximum frame rate available for this setup, the bandwidth for image traffic is 450 MByte/s.

Image format	Width [pixels]	Height [pixels]	ROI area [MP]	Frame rate [fps] <sup>1</sup>		
				450 MByte/s	375 MByte/s	200 MByte/s
Full resolution	816	624	0.509	688.5/350.2/354.0	577.5/297.9/303.5	319.7/161.0/165.1
SVGA	800	600	0.48	703.6/364.2/369.6	603.5/309.0/316.0	330.4/168.6/172.2
VGA	640	480	0.307	851.7/548.2/556.2	851.7/465.9/469.5	497.4/255.4/258.7
HVGA	480	320	0.154	1151.8/955.4/849.9	1151.8/836.8/849.9	887.1/455.3/468.7
QVGA	320	240	0.077	1410.7/1171.9/1050.9		1410.7/822.8/854.6
HQVGA	240	160	0.038	1801.8/1500.0/1361.7		1801.8/1379.6/1361.7
QQVGA	160	120	0.019	2044.8/1698.1/1559.3		
Max. × half	816	312	0.255	1116.5/578.2/590.0	943.2/493.4/508.1	531.0/269.3/279.7
Max. × min.	816	8	0.007	2951.1/1656.4/1769.9	2572.4/1436.9/1559.0	1565.7/822.4/914.4
Min. × max.	8	624	0.005	721.2/596.8/524.7		721.2/596.8/524.7
Min. × min.	8	8	64 P	3664.1/3082.2/2997.8		

<sup>1</sup> Mono8 or Bayer...8<sup>(2)</sup> at **SensorBitDepth** = 8-Bit<sup>(3)</sup> /  
 Mono10 or Bayer...10 at **SensorBitDepth** = 10-Bit /  
 Mono12 or Bayer...12 at **SensorBitDepth** = 12-Bit

<sup>2</sup> The three dots... represent the colors of a Bayer pixel format, such as in Bayer**RG8**.

<sup>3</sup> The **SensorBitDepth** value must be set separately from **PixelFormat**.  
 See [Sensor ADC readout modes for maximum frame rates](#) on page 68 for details.

Table 27: Alvium 1800 U-052m/c ROI frame rates

## Alvium 1800 U-120m/c

Feature	Specification	
	1800 U-120m (monochrome)	1800 U-120c (color)
Sensor model	ON Semiconductor AR0135CS	
Resolution	1280 (H) × 960 (V); 1.2 MP	
Sensor type	CMOS	
Shutter type	Global shutter (GS)	
Sensor size	Type 1/3; 4.8 mm × 3.6 mm; 6.0 mm diagonal	
Pixel size	3.75 μm × 3.75 μm	
CRA	0 deg	
Sensor bit depth (ADC)	12-bit	
Monochrome pixel formats	Mono8 (default), Mono10, Mono10p, Mono12, Mono12p	Mono8, Mono10, Mono10p, Mono12, Mono12p
YUV color pixel formats	Not applicable	YCbCr411_8_CbYYCrYY, YCbCr422_8_CbYCrY, YCbCr8_CbYCr
RGB color pixel formats	Not applicable	BGR8, RGB8 (default)
Raw color pixel formats	Not applicable	BayerRG8, BayerRG10, BayerRG10p, BayerRG12, BayerRG12p
Maximum frame rate	52 fps <sup>1</sup> (at ≥200 MByte/s)	
Exposure time	57 μs to 8 s (200 MByte/s)	
Exposure modes	Timed	
Gain	0 dB to 17.7 dB; 0.1 dB increments	
Digital binning	Horizontal: 1 to 8 columns; Vertical: 1 to 8 rows	
Image buffer (RAM)	256 KByte	
Non-volatile memory (Flash)	1024 KByte	
GPIOs	4 programmable GPIOs As direct inputs (push-pull): 0 to 5.5 VDC As direct outputs (push-pull): 0 to 3.3 VDC at 12 mA	
Power requirements	Power over USB; External power	
Power consumption (typical, at 5 VDC)	USB power: 1.3 W External power: 1.5 W	

<sup>1</sup> In triggered mode, maximum frame rates require minimum exposure times.

Table 28: Alvium 1800 U-120m/c specifications (sheet 1 of 2)

Feature	Specification			
	<b>1800 U-120m/c</b>			
Storage temperature	-20 °C to +85 °C ambient temperature			
<b>Operating temperature</b>	<b>Hardware option</b>	<b>Housing</b>	<b>Cooling area<sup>1</sup></b>	<b>Mainboard<sup>2</sup></b>
	Bare board <sup>3</sup>	Not applicable	-20 °C to +85 °C	-20 °C to +85 °C
	Open housing <sup>4</sup>	-20 °C to +65 °C		
	Closed housing	-20 °C to +65 °C	Not applicable	
Relative humidity	0% to 80% (non-condensing)			
Digital interface	Micro-B USB 3.1 Gen 1 interface			
Camera controls	GenICam (GenICam Access)			

<sup>1</sup> See [Mounting the heat sink](#) on page 259.

<sup>2</sup> Output by DeviceTemperature

<sup>3</sup> Ensure that the sensor is operated in the temperature range specified by the manufacturer. For any questions, please visit [www.alliedvision.com/en/support](http://www.alliedvision.com/en/support).

<sup>4</sup> Temperature values must be observed for the housing **and** for the cooling area.

Table 28: Alvium 1800 U-120m/c specifications (sheet 2 of 2)

### Absolute QE

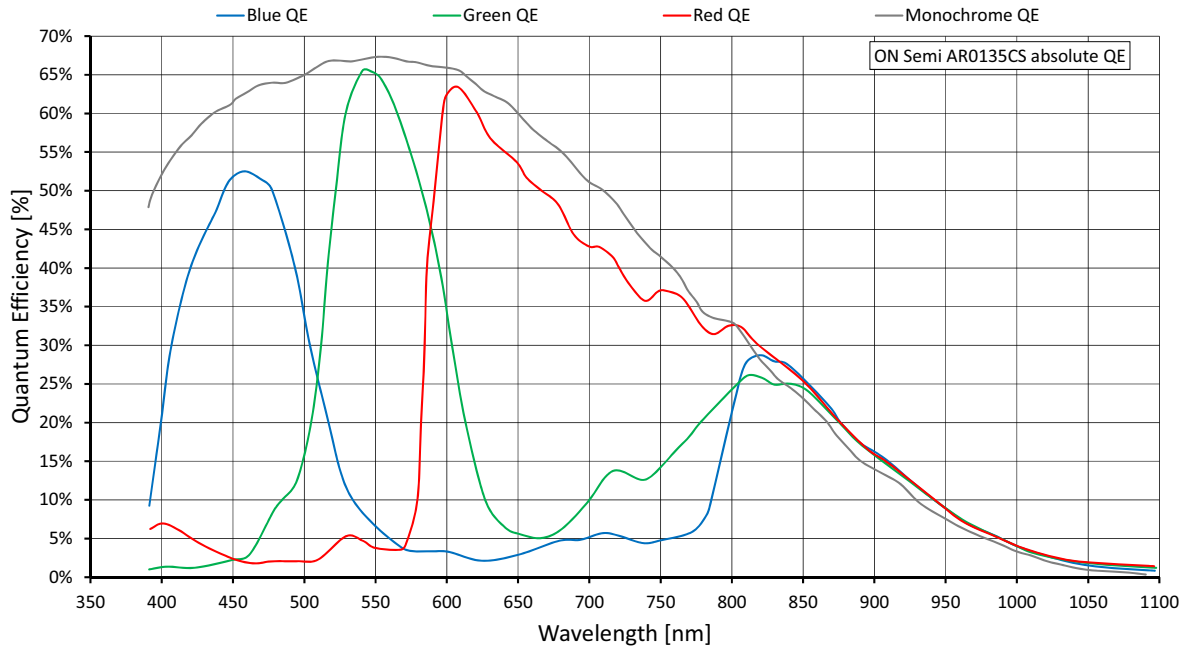

Figure 15: Alvium 1800 U-120m/c (ON Semi AR0135CS) absolute QE

### Spectral response

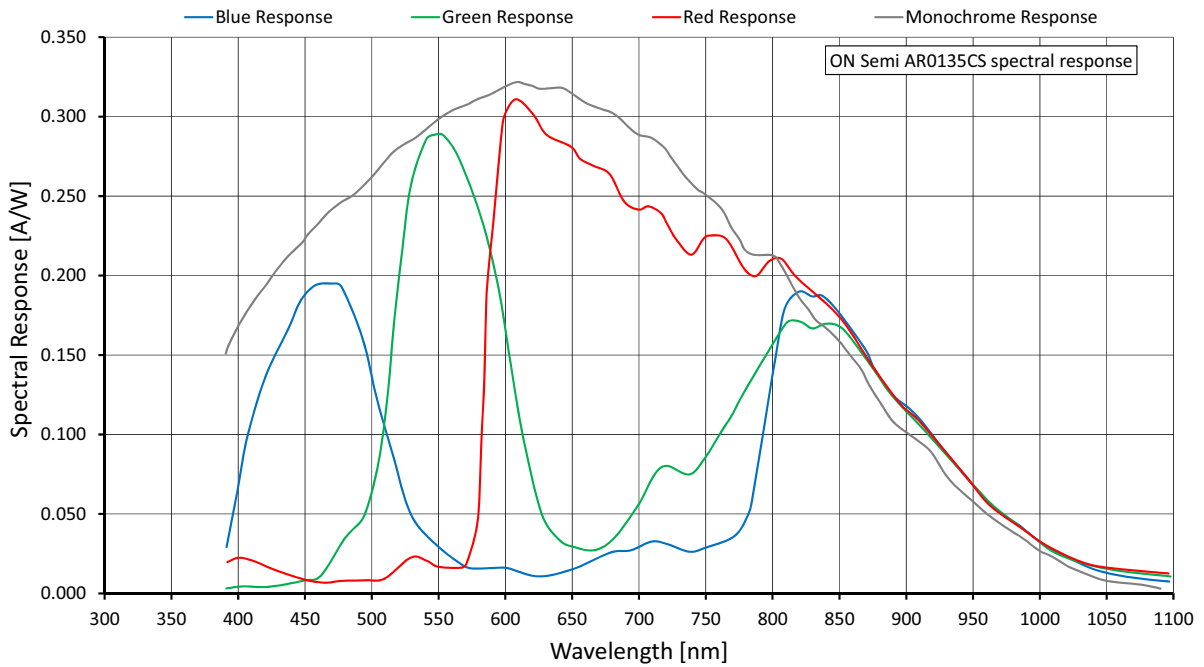

Figure 16: Alvium 1800 U-120m/c (ON Semi AR0135CS) spectral response

## ROI frame rates

Values were measured as defined in [Specified values](#) on page 67.

To reach the maximum frame rate available for this setup, the bandwidth for image traffic is 200 MByte/s. Increasing the `DeviceLinkThroughputLimit` value does not increase frame rates.

Alvium 1800 U-120 cameras do not allow overlapping of exposure and readout. **In triggered mode**, the maximum available frame rates may be reduced with long exposure times.

Image format	Width [pixels]	Height [pixels]	ROI area [MP]	Frame rate [fps] <sup>1</sup>		
				450 MByte/s	375 MByte/s	200 MByte/s
Full resolution	1280	960	1.229	52.8/52.8		
HD 720	1280	720	0.922	69.2/69.3	69.3/69.3	
XGA	1024	768	0.786	65.2/65.2		
SVGA	800	600	0.48	82.0/82.0		
VGA	640	480	0.307	100.5/100.5		
HVGA	480	320	0.154	143.8/143.8		
QVGA	320	240	0.077	161.2/161.2		
HQVGA	240	160	0.038	161.2/161.2		
QQVGA	160	120	0.019	161.2/161.2		
Max. × half	1280	480	0.614	100.5/100.5		
Max. × min.	1280	8	0.01	160.9/160.9		
Min. × max.	8	960	0.008	52.9/52.9		
Min. × min.	8	8	64 P	161.2/161.2		

<sup>1</sup> Mono8 or Bayer...8<sup>(2)</sup> at `SensorBitDepth` = 12-Bit / Mono12 or Bayer...12 at `SensorBitDepth` = 12-Bit  
<sup>2</sup> The three dots... represent the colors of a Bayer pixel format, such as in BayerRG8.

Table 29: Alvium 1800 U-120m/c ROI frame rates

## Alvium 1800 U-130 VSWIR

Feature	Specification
	<b>1800 U-130 VSWIR</b>
Sensor model	Sony IMX990
Resolution	1296 (H) × 1032 (V); 1.3 MP
Sensor type	InGaAs
Shutter type	Global shutter (GS)
Sensor size	Type 1/2; 6.4 mm × 5.1 mm; 8.2 mm diagonal
Pixel size	5 μm × 5 μm
CRA	0 deg
Sensor bit depth (ADC)	8-bit, 10-bit, 12-bit; Adaptive (10-bit, 12-bit)
Monochrome pixel formats	Mono8 (default), Mono10, Mono10p, Mono12, Mono12p
Maximum frame rate	130 fps (at ≥200 MByte/s)
Exposure time	15 μs to 10 s (200 MByte/s)
Exposure modes	Timed, TriggerControlled, TriggerWidth
Gain	0 dB to 42 dB; 0.1 dB increments
Digital binning	Horizontal: 1 to 8 columns; Vertical: 1 to 8 rows
Multiple ROI (H × V)	<i>Free   Tile   Horizontal</i> : 1 × 1 to 1 × 4   <i>Vertical</i> : 1 × 1 to 4 × 1
Image buffer (RAM)	256 KByte
Non-volatile memory (Flash)	1024 KByte
GPIOs	4 programmable GPIOs As direct inputs (push-pull): 0 to 5.5 VDC As direct outputs (push-pull): 0 to 3.3 VDC at 12 mA
Power requirements	Power over USB; External power
Power consumption (typical, at 5 VDC)	USB power: 2.1 W External power: 2.3 W

Table 30: Alvium 1800 U-130 VSWIR specifications (sheet 1 of 2)

Feature	Specification			
	<b>1800 U-130 VSWIR</b>			
Storage temperature	-20 °C to +85 °C ambient temperature			
<b>Operating temperature</b>	<b>Hardware option</b>	<b>Housing</b>	<b>Cooling area<sup>1</sup></b>	<b>Mainboard<sup>2</sup></b>
	Bare board <sup>3</sup>	Not applicable	-20 °C to +85 °C	-20 °C to +85 °C
	Open housing <sup>4</sup>	-20 °C to +65 °C		
	Closed housing	-20 °C to +65 °C	Not applicable	
Relative humidity	0% to 80% (non-condensing)			
Digital interface	Micro-B USB 3.1 Gen 1 interface			
Camera controls	GenICam (GenICam Access)			

<sup>1</sup> See [Mounting the heat sink](#) on page 259.

<sup>2</sup> Output by DeviceTemperature

<sup>3</sup> Ensure that the sensor is operated in the temperature range specified by the manufacturer. For any questions, please visit [www.alliedvision.com/en/support](http://www.alliedvision.com/en/support).

<sup>4</sup> Temperature values must be observed for the housing **and** for the cooling area.

Table 30: Alvium 1800 U-130 VSWIR specifications (sheet 2 of 2)

## Absolute QE

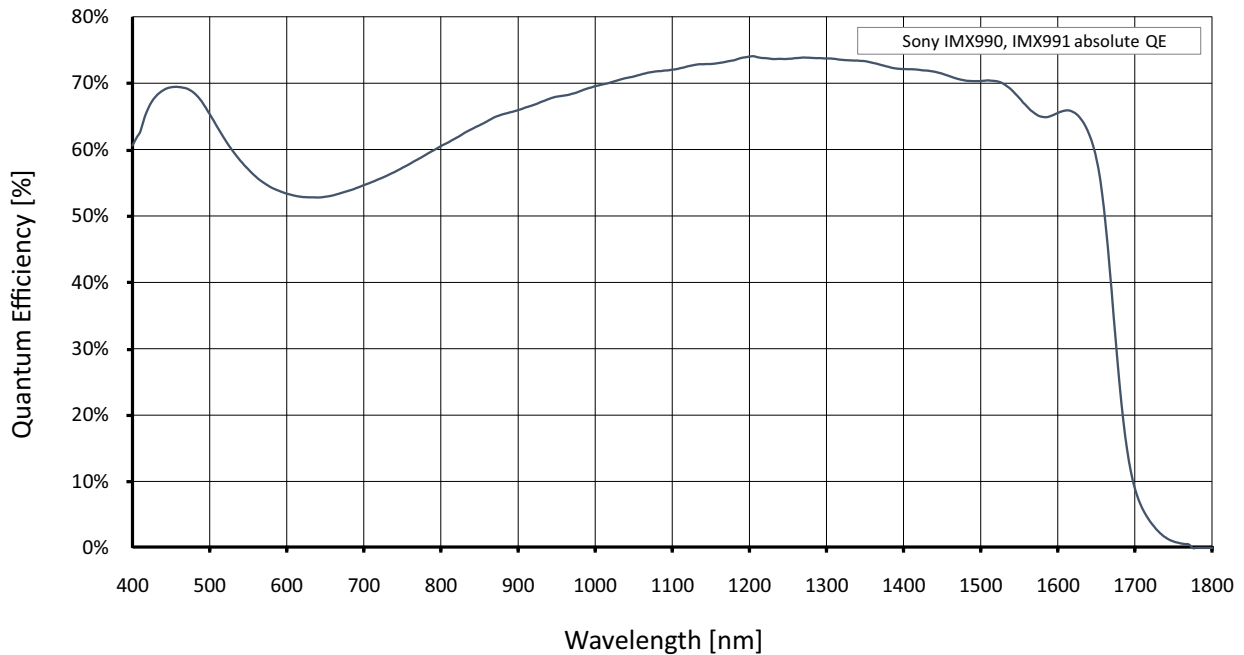

Figure 17: Alvium 1800 U-130 VSWIR (Sony IMX990) absolute QE

## ROI frame rates

Values were measured as defined in [Specified values](#) on page 67.

To reach the maximum frame rate available for this setup, the bandwidth for image traffic is 200 MByte/s. Increasing the `DeviceLinkThroughputLimit` value does not increase frame rates.

Image format	Width [pixels]	Height [pixels]	ROI area [MP]	Frame rate [fps] <sup>1</sup>		
				450 MByte/s	375 MByte/s	200 MByte/s
Full resolution	1296	1032	1.337	130.9/121.3/69.8		130.9/70.8/69.8
SXGA	1280	1024	1.311	131.8/122.2/70.3		131.8/72.4/70.3
HD 720	1280	720	0.922	183.3/169.8/97.8		183.3/100.8/97.8
XGA	1024	768	0.786	173.1/160.5/92.4		173.1/118.7/92.4
SVGA	800	600	0.48	218.3/202.1/116.4		218.3/190.5/116.4
VGA	640	480	0.307	267.9/248.3/143.0		267.9/248.3/143.0
HVGA	480	320	0.154	384.9/356.4/205.2		
QVGA	320	240	0.077	494.1/457.2/262.7		
HQVGA	240	160	0.038	683.2/634.4/365.0		
QQVGA	160	120	0.019	849.9/789.2/454.6		
Max. × half	1296	516	0.669	246.6/228.2/131.8		
Max. × min.	1296	8	0.01	2131.1/1921.6/1186.2		
Min. × max.	8	1032	0.008	132.5/123.0/70.4		
Min. × min.	8	8	64 P	2644.2/2455.3/1405.9		

<sup>1</sup> Mono8 at `SensorBitDepth` = 8-Bit<sup>(2)</sup> / Mono10 at `SensorBitDepth` = 10-Bit / Mono12 or at `SensorBitDepth` = 12-Bit

<sup>2</sup> The `SensorBitDepth` value must be set separately from `PixelFormat`. See [Sensor ADC readout modes for maximum frame rates](#) on page 68 for details.

Table 31: Alvium 1800 U-130 VSWIR ROI frame rates



## Alvium 1800 U-131m/c (coming soon)

Feature	Specification	
	1800 U-131m (monochrome)	1800 U-131c (color)
Sensor model	e2v EV76C560 Sapphire	
Resolution	1280 (H) × 1024 (V); 1.3 MP	
Sensor type	CMOS	
Shutter type	Global shutter (GS)	
Sensor size	Type 1/1.8; 6.9 mm × 5.5 mm; 8.7 mm diagonal	
Pixel size	5.3 μm × 5.3 μm	
CRA	12 deg	
Sensor bit depth (ADC)	10-bit	
Monochrome pixel formats	Mono8 (default), Mono10, Mono10p, Mono12, Mono12p	Mono8, Mono10, Mono10p, Mono12, Mono12p
YUV color pixel formats	Not applicable	YCbCr411_8_CbYYCrYY, YCbCr422_8_CbYCrY, YCbCr8_CbYCr
RGB color pixel formats	Not applicable	BGR8, RGB8 (default)
Raw color pixel formats	Not applicable	BayerRG8, BayerRG10, BayerRG10p, BayerRG12, BayerRG12p
Maximum frame rate	59 fps (at ≥200 MByte/s)	
Exposure time	16 μs to 8 s (200 MByte/s)	
Exposure modes	Timed	
Gain	0 dB to 48 dB; 0.1 dB increments	
Digital binning	Horizontal: 1 to 8 columns; Vertical: 1 to 8 rows	
Image buffer (RAM)	256 KByte	
Non-volatile memory (Flash)	1024 KByte	
GPIOs	4 programmable GPIOs As direct inputs (push-pull): 0 to 5.5 VDC As direct outputs (push-pull): 0 to 3.3 VDC at 12 mA	
Power requirements	Power over USB; External power	
Power consumption (typical, at 5 VDC)	USB power: 1.5 W External power: 1.5 W	

Table 32: Alvium 1800 U-131m/c specifications (sheet 1 of 2)

Feature	Specification			
	<b>1800 U-131m/c</b>			
Storage temperature	-20 °C to +85 °C ambient temperature			
<b>Operating temperature</b>	<b>Hardware option</b>	<b>Housing</b>	<b>Cooling area<sup>1</sup></b>	<b>Mainboard<sup>2</sup></b>
	Bare board <sup>3</sup>	Not applicable	-20 °C to +85 °C	-20 °C to +85 °C
	Open housing <sup>4</sup>	-20 °C to +65 °C		
	Closed housing	-20 °C to +65 °C	Not applicable	
Relative humidity	0% to 80% (non-condensing)			
Digital interface	Micro-B USB 3.1 Gen 1 interface			
Camera controls	GenICam (GenICam Access)			
<sup>1</sup> See <a href="#">Mounting the heat sink</a> on page 259. <sup>2</sup> Output by DeviceTemperature <sup>3</sup> Ensure that the sensor is operated in the temperature range specified by the manufacturer. For any questions, please visit <a href="http://www.alliedvision.com/en/support">www.alliedvision.com/en/support</a> . <sup>4</sup> Temperature values must be observed for the housing <b>and</b> for the cooling area.				

Table 32: Alvium 1800 U-131m/c specifications (sheet 2 of 2)

## Absolute QE, spectral response

We intend to add diagrams in a future version of this document.

## ROI frame rates

Values were measured as defined in [Specified values](#) on page 67.

To reach the maximum frame rate available for this setup, the bandwidth for image traffic is 200 MByte/s.

Image format	Width [pixels]	Height [pixels]	ROI area [MP]	Frame rate [fps] <sup>1</sup>		
				450 MByte/s	375 MByte/s	200 MByte/s
Full resolution, SXGA	1280	1024	1.311	59 / 59		
HD 720	1280	720	0.922	85.6 / 85.6		
XGA	1024	768	0.786	80.4 / 80.4		
SVGA	800	600	0.480	102.1 / 102.1		
VGA	640	480	0.307	126.5 / 126.5		
HVGA	480	320	0.154	185.4 / 185.4		
QVGA	320	240	0.077	241.8 / 241.8		
HQVGA	240	160	0.038	347.6 / 347.6		
QQVGA	160	120	0.019	444.8 / 444.8		
Max. × half	1280	512	0.655	118.9 / 118.9		
Max. × min.	1280	8	0.010	2051.8 / 2051.8		
Min. × max.	8	1024	0.008	59 / 59		
Min. × min.	8	8	64 P	2051.8 / 2051.8		

<sup>1</sup> Mono8 or Bayer...8<sup>(2)</sup> at `SensorBitDepth` = 10-Bit<sup>(3)</sup> / Mono10 or Bayer...10 at `SensorBitDepth` = 10-Bit

<sup>2</sup> The three dots... represent the colors of a Bayer pixel format, such as in BayerRG8.

<sup>3</sup> The `SensorBitDepth` value must be set separately from `PixelFormat`. See [Sensor ADC readout modes for maximum frame rates](#) on page 68 for details.

Table 33: Alvim 1800 U-131m/c ROI frame rates (calculated values)

## Alvium 1800 U-158m/c

Feature	Specification	
	1800 U-158m (monochrome)	1800 U-158c (color)
Sensor model	Sony IMX273	
Resolution	1456 (H) × 1088 (V); 1.6 MP	
Sensor type	CMOS	
Shutter type	Global shutter (GS)	
Sensor size	Type 1/2.9; 5.0 mm × 3.8 mm; 6.3 mm diagonal	
Pixel size	3.45 μm × 3.45 μm	
CRA	0 deg	
Sensor bit depth (ADC)	8-bit, 10-bit, 12-bit; Adaptive (10-bit, 12-bit)	
Monochrome pixel formats	Mono8 (default), Mono10, Mono10p, Mono12, Mono12p	Mono8, Mono10, Mono10p, Mono12, Mono12p
YUV color pixel formats	Not applicable	YCbCr411_8_CbYYCrYY, YCbCr422_8_CbYCrY, YCbCr8_CbYCr
RGB color pixel formats	Not applicable	BGR8, RGB8 (default)
Raw color pixel formats	Not applicable	BayerRG8, BayerRG10, BayerRG10p, BayerRG12, BayerRG12p
Maximum frame rate	257 fps (at 450 MByte/s)	
Exposure time	28 μs to 10 s (450 MByte/s)	
Exposure modes	Timed, TriggerControlled, TriggerWidth	
Gain	0 dB to 48 dB; 0.1 dB increments	
Digital binning	Horizontal: 1 to 8 columns; Vertical: 1 to 8 rows	
Sensor binning (H × V)	1 × 2, 2 × 2 ( <i>Sum</i> )	Not applicable
Multiple ROI (H × V)	<i>Free</i>   <i>Tile</i>	
Image buffer (RAM)	256 KByte	
Non-volatile memory (Flash)	1024 KByte	
GPIOs	4 programmable GPIOs As direct inputs (push-pull): 0 to 5.5 VDC As direct outputs (push-pull): 0 to 3.3 VDC at 12 mA	
Power requirements	Power over USB; External power	
Power consumption (typical, at 5 VDC)	USB power: 2.5 W External power: 2.6 W	

Table 34: Alvium 1800 U-158m/c specifications (sheet 1 of 2)

Feature	Specification			
	<b>1800 U-158m/c</b>			
Storage temperature	-20 °C to +85 °C ambient temperature			
<b>Operating temperature</b>	<b>Hardware option</b>	<b>Housing</b>	<b>Cooling area<sup>1</sup></b>	<b>Mainboard<sup>2</sup></b>
	Bare board <sup>3</sup>	Not applicable	-20 °C to +85 °C	-20 °C to +85 °C
	Open housing <sup>4</sup>	-20 °C to +65 °C		
	Closed housing	-20 °C to +65 °C	Not applicable	
Relative humidity	0% to 80% (non-condensing)			
Digital interface	Micro-B USB 3.1 Gen 1 interface			
Camera controls	GenICam (GenICam Access)			
<sup>1</sup> See <a href="#">Mounting the heat sink</a> on page 259. <sup>2</sup> Output by DeviceTemperature <sup>3</sup> Ensure that the sensor is operated in the temperature range specified by the manufacturer. For any questions, please visit <a href="http://www.alliedvision.com/en/support">www.alliedvision.com/en/support</a> . <sup>4</sup> Temperature values must be observed for the housing <b>and</b> for the cooling area.				

Table 34: Alvium 1800 U-158m/c specifications (sheet 2 of 2)

### Absolute QE

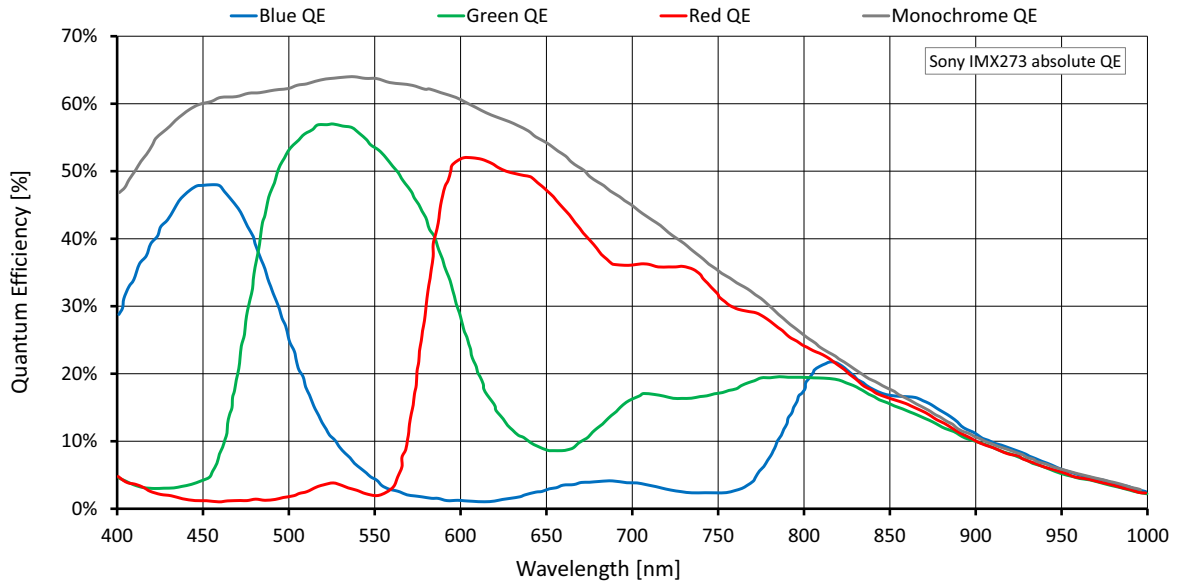

Figure 18: Alvium 1800 U-158m/c (Sony IMX273) absolute QE

### Spectral response

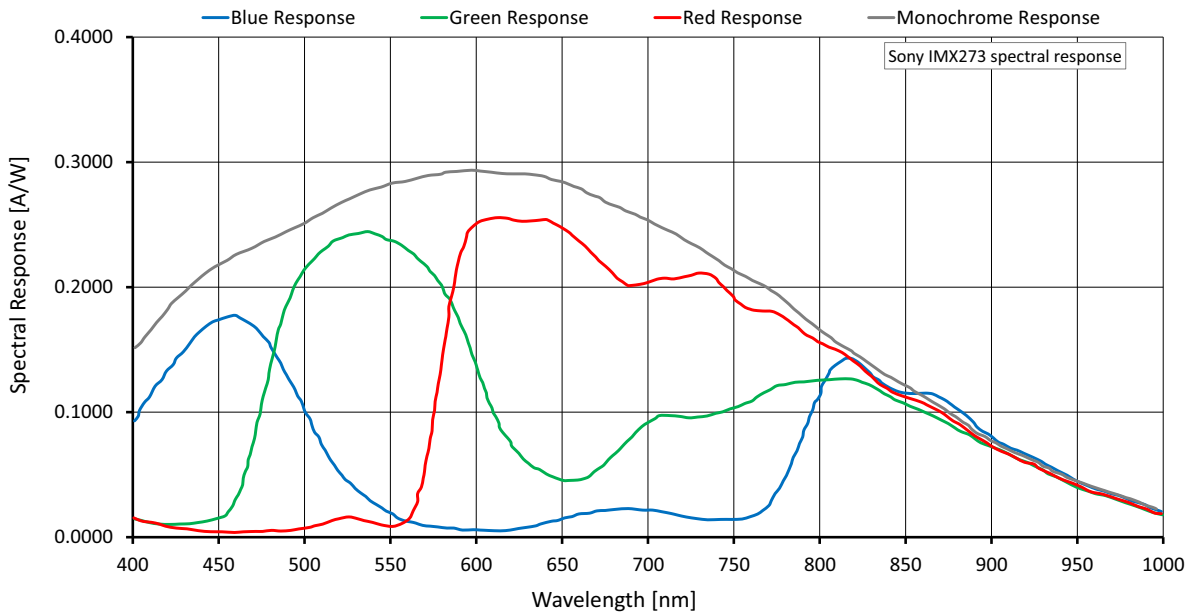

Figure 19: Alvium 1800 U-158m/c (Sony IMX273) spectral response

## ROI frame rates

Values were measured as defined in [Specified values](#) on page 67.

To reach the maximum frame rate available for this setup, the bandwidth for image traffic is 450 MByte/s.

Image format	Width [pixels]	Height [pixels]	ROI area [MP]	Frame rate [fps] <sup>1</sup>		
				450 MByte/s	375 MByte/s	200 MByte/s
Full resolution	1456	1088	1.584	257.9/130.3/130.8	216.8/110.5/109.7	118.1/59.8/59.3
WXGA+	1440	900	1.296	311.9/158.7/157.8	261.7/134.2/133.6	143.1/72.1/71.7
SXGA	1280	1024	1.311	278.2/157.1/155.7	261.3/133.0/132.5	142.8/72.0/71.5
HD 720	1280	720	0.922	382.9/217.2/214.8	359.8/184.1/183.1	198.0/99.9/99.3
XGA	1024	768	0.786	364.0/255.0/218.8	364.0/215.8/215.9	233.4/117.7/117.1
SVGA	800	600	0.48	457.6/372.9/275.3	457.6/344.8/275.3	368.8/188.5/188.2
VGA	640	480	0.307	560.5/456.8/337.7		560.5/288.4/284.3
HVGA	480	320	0.154	795.3/650.4/482.2		795.3/538.5/482.2
QVGA	320	240	0.077	1001.2/830.7/615.7		
HQVGA	240	160	0.038	1351.0/1138.9/847.2		
QQVGA	160	120	0.019	1636.9/1390.6/1037.6		
Max. × half	1456	544	0.792	478.5/244.8/244.8	404.3/208.2/206.1	223.0/113.4/112.4
Max. × min.	1456	8	0.012	3043.0/1825.6/ 1736.1	2734.2/1620.4/ 1537.1	1795.9/982.1/949.6
Min. × max.	8	1088	0.009	267.4/219.1/161.2		
Min. × min.	8	8	64 P	4017.8/3647.7/2798.5		

<sup>1</sup> Mono8 or Bayer...8<sup>(2)</sup> at **SensorBitDepth** = 8-Bit<sup>(3)</sup> /  
 Mono10 or Bayer...10 at **SensorBitDepth** = 10-Bit /  
 Mono12 or Bayer...12 at **SensorBitDepth** = 12-Bit

<sup>2</sup> The three dots... represent the colors of a Bayer pixel format, such as in BayerRG8.

<sup>3</sup> The **SensorBitDepth** value must be set separately from **PixelFormat**.  
 See [Sensor ADC readout modes for maximum frame rates](#) on page 68 for details.

Table 35: Alvium 1800 U-158m/c ROI frame rates

## Alvium 1800 U-192m/c (coming soon)

Feature	Specification	
	1800 U-192m (monochrome)	1800 U-192c (color)
Sensor model	e2v EV76C570 Sapphire	
Resolution	1600 (H) × 1200 (V); 1.92 MP	
Sensor type	CMOS	
Shutter type	Global shutter (GS)	
Sensor size	Type 1/1.8; 7.2 mm × 5.4 mm; 9.0 mm diagonal	
Pixel size	4.5 μm × 4.5 μm	
CRA	12 deg	
Sensor bit depth (ADC)	10-bit	
Monochrome pixel formats	Mono8 (default), Mono10, Mono10p, Mono12, Mono12p	Mono8, Mono10, Mono10p, Mono12, Mono12p
YUV color pixel formats	Not applicable	YCbCr411_8_CbYYCrYY, YCbCr422_8_CbYCrY, YCbCr8_CbYCr
RGB color pixel formats	Not applicable	BGR8, RGB8 (default)
Raw color pixel formats	Not applicable	BayerRG8, BayerRG10, BayerRG10p, BayerRG12, BayerRG12p
Maximum frame rate	59 fps (at ≥200 MByte/s)	
Exposure time	14 μs to 0.8 s (200 MByte/s)	
Exposure modes	Timed	
Gain	0 dB to 48 dB; 0.1 dB increments	
Digital binning	Horizontal: 1 to 8 columns; Vertical: 1 to 8 rows	
Image buffer (RAM)	256 KByte	
Non-volatile memory (Flash)	1024 KByte	
GPIOs	4 programmable GPIOs As direct inputs (push-pull): 0 to 5.5 VDC As direct outputs (push-pull): 0 to 3.3 VDC at 12 mA	
Power requirements	Power over USB; External power	
Power consumption (typical, at 5 VDC)	USB power: 1.6 W External power: 1.6 W	

Table 36: Alvium 1800 U-192m/c specifications (sheet 1 of 2)



Feature	Specification			
	<b>1800 U-192m/c</b>			
Storage temperature	-20 °C to +85 °C ambient temperature			
<b>Operating temperature</b>	<b>Hardware option</b>	<b>Housing</b>	<b>Cooling area<sup>1</sup></b>	<b>Mainboard<sup>2</sup></b>
	Bare board <sup>3</sup>	Not applicable	-20 °C to +85 °C	-20 °C to +85 °C
	Open housing <sup>4</sup>	-20 °C to +65 °C		
	Closed housing	-20 °C to +65 °C	Not applicable	
Relative humidity	0% to 80% (non-condensing)			
Digital interface	Micro-B USB 3.1 Gen 1 interface			
Camera controls	GenICam (GenICam Access)			
<sup>1</sup> See <a href="#">Mounting the heat sink</a> on page 259. <sup>2</sup> Output by DeviceTemperature <sup>3</sup> Ensure that the sensor is operated in the temperature range specified by the manufacturer. For any questions, please visit <a href="http://www.alliedvision.com/en/support">www.alliedvision.com/en/support</a> . <sup>4</sup> Temperature values must be observed for the housing <b>and</b> for the cooling area.				

Table 36: Alvium 1800 U-192m/c specifications (sheet 2 of 2)

## Absolute QE, spectral response

We intend to add diagrams in a future version of this document.

## ROI frame rates

Values were measured as defined in [Specified values](#) on page 67.

To reach the maximum frame rate available for this setup, the bandwidth for image traffic is 200 MByte/s.

Image format	Width [pixels]	Height [pixels]	ROI area [MP]	Frame rate [fps] <sup>1</sup>		
				450 MByte/s	375 MByte/s	200 MByte/s
Full resolution	1600	1200	1.920	59.5 / 59.5		59.5 / 51.1
UXGA	1600	1200	1.920	59.5 / 59.5		59.5 / 51.1
WXGA+	1440	900	1.296	79.7 / 79.7		79.7 / 75.2
SXGA	1280	1024	1.311	70.2 / 70.2		
HD 720	1280	720	0.922	99.0 / 99.0		
XGA	1024	768	0.786	93.0 / 93.0		
SVGA	800	600	0.480	118.0 / 118.0		
VGA	640	480	0.307	146.2 / 146.2		
HVGA	480	320	0.154	214.4 / 214.4		
QVGA	320	240	0.077	279.6 / 279.6		
HQVGA	240	160	0.038	401.8 / 401.8		
QQVGA	160	120	0.019	514.2 / 514.2		
Max. x half	1600	600	0.960	116.9 / 116.9		116.9 / 100.3
Max. x min.	1600	8	0.013	2348.9 / 2348.9		2348.9 / 2016.1
Min. x max.	8	1200	0.010	60.1 / 60.1		
Min. x min.	8	8	64 P	2371.9 / 2371.9		

<sup>1</sup> Mono8 or Bayer...8<sup>(2)</sup> at **SensorBitDepth** = 8-Bit<sup>(3)</sup> / Mono10 or Bayer...10 at **SensorBitDepth** = 10-Bit

<sup>2</sup> The three dots... represent the colors of a Bayer pixel format, such as in BayerRG8.

<sup>3</sup> The **SensorBitDepth** value must be set separately from **PixelFormat**.

See [Sensor ADC readout modes for maximum frame rates](#) on page 68 for details.

Table 37: Alvium 1800 U-192m/c ROI frame rates (calculated values)

## Alvium 1800 U-203m/c

Feature	Specification	
	1800 U-203m (monochrome)	1800 U-203c (color)
Sensor model	IMX422	
Resolution	1632 (H) × 1248 (V); 2.03 MP	
Sensor type	CMOS	
Shutter type	Global shutter (GS)	
Sensor size	Type 1/1.7; 7.3 mm × 5.6 mm; 9.2 mm diagonal	
Pixel size	4.5 μm × 4.5 μm	
CRA	0° deg	
Sensor bit depth (ADC)	8-bit, 10-bit, 12-bit; Adaptive (10-bit, 12-bit)	
Monochrome pixel formats	Mono8 (default), Mono10, Mono10p, Mono12, Mono12p	Mono8, Mono10, Mono10p, Mono12, Mono12p
YUV color pixel formats	Not applicable	YCbCr411_8_CbYYCrYY, YCbCr422_8_CbYCrY, YCbCr8_CbYCr
RGB color pixel formats	Not applicable	BGR8, RGB8 (default)
Raw color pixel formats	Not applicable	BayerRG8, BayerRG10, BayerRG10p, BayerRG12, BayerRG12p
Maximum frame rate	200 fps (at 450 MByte/s)	
Exposure time	16 μs to 10 s (450 MByte/s)	
Exposure modes	Timed, TriggerControlled, TriggerWidth	
Gain	0 dB to 48 dB; 0.1 dB increments	
Digital binning	Horizontal: 1 to 8 columns; Vertical: 1 to 8 rows	
Sensor binning (H × V)	2 × 2 ( <i>Sum, Average</i> )	Not applicable
Multiple ROI (H × V)	<i>Free   Tile   Horizontal</i> : 1 × 1 to 1 × 4   <i>Vertical</i> : 1 × 1 to 4 × 1	
Image buffer (RAM)	256 KByte	
Non-volatile memory (Flash)	1024 KByte	
GPIOs	4 programmable GPIOs As direct inputs (push-pull): 0 to 5.5 VDC As direct outputs (push-pull): 0 to 3.3 VDC at 12 mA	
Power requirements	Power over USB; External power	
Power consumption (typical, at 5 VDC)	USB power: 3.3 W External power: 3.3 W	

Table 38: Alvium 1800 U-203m/c specifications (sheet 1 of 2)

Feature	Specification			
	<b>1800 U-203m/c</b>			
Storage temperature	-20 °C to +85 °C ambient temperature			
<b>Operating temperature</b>	<b>Hardware option</b>	<b>Housing</b>	<b>Cooling area<sup>1</sup></b>	<b>Mainboard<sup>2</sup></b>
	Bare board <sup>3</sup>	Not applicable	-20 °C to +85 °C	-20 °C to +85 °C
	Open housing <sup>4</sup>	-20 °C to +65 °C		
	Closed housing	-20 °C to +65 °C	Not applicable	
Relative humidity	0% to 80% (non-condensing)			
Digital interface	Micro-B USB 3.1 Gen 1 interface			
Camera controls	GenICam (GenICam Access)			
<sup>1</sup> See <a href="#">Mounting the heat sink</a> on page 259. <sup>2</sup> Output by DeviceTemperature <sup>3</sup> Ensure that the sensor is operated in the temperature range specified by the manufacturer. For any questions, please visit <a href="http://www.alliedvision.com/en/support">www.alliedvision.com/en/support</a> . <sup>4</sup> Temperature values must be observed for the housing <b>and</b> for the cooling area.				

*Table 38: Alvium 1800 U-203m/c specifications (sheet 2 of 2)*

## Absolute QE, spectral response

We intend to add diagrams in a future version of this document.

## ROI frame rates

Values were measured as defined in [Specified values](#) on page 67.

To reach the maximum frame rate available for this setup, the bandwidth for image traffic is 450 MByte/s.

Image format	Width [pixels]	Height [pixels]	ROI area [MP]	Frame rate [fps] <sup>1</sup>		
				450 MByte/s	375 MByte/s	200 MByte/s
Full resolution	1632	1248	2.037	200.0/101.0/100.7	168.8/84.9/85.2	91.0/45.7/45.9
WXGA+	1440	900	1.296	302.7/153.9/153.8	254.0/130.1/130.1	138.8/70.0/69.8
SXGA	1280	1024	1.311	271.9/153.5/152.6	255.3/129.9/129.9	139.5/70.3/70.1
HD 720	1280	720	0.922	370.9/210.3/209.1	348.6/178.2/178.2	191.6/96.7/96.6
XGA	1024	768	0.786	353.2/247.4/245.0	353.2/209.4/210.4	226.4/114.1/114.1
SVGA	800	600	0.48	440.7/359.0/306.1	440.7/331.9/306.1	355.1/181.4/182.2
VGA	640	480	0.307	535.2/436.2/373.0	535.2/436.2/373.0	535.2/275.2/273.3
HVGA	480	320	0.154	747.3/609.4/522.9		747.3/504.3/505.5
QVGA	320	240	0.077	937.5/765.0/658.5		
HQVGA	240	160	0.038	1247.5/1019.0/881.7		
QQVGA	160	120	0.019	1501.8/1227.8/1066.8		
Max. × half	1632	624	1.018	368.4/187.9/187.3	312.2/158.4/158.9	170.1/85.8/86.3
Max. × min.	1632	8	0.013	2183.8/1249.9/ 1236.2	1942.1/1087.9/ 1091.3	1197.3/636.6/651.7
Min. × max.	8	1248	0.01	232.6/189.4/161.1		
Min. × min.	8	8	64 P	3437.4/2828.0/2540.0		

<sup>1</sup> Mono8 or Bayer...8<sup>(2)</sup> at **SensorBitDepth** = 8-Bit<sup>(3)</sup> /  
 Mono10 or Bayer...10 at **SensorBitDepth** = 10-Bit /  
 Mono12 or Bayer...12 at **SensorBitDepth** = 12-Bit

<sup>2</sup> The three dots... represent the colors of a Bayer pixel format, such as in Bayer**RG8**.

<sup>3</sup> The **SensorBitDepth** value must be set separately from **PixelFormat**.

See [Sensor ADC readout modes for maximum frame rates](#) on page 68 for details.

Table 39: Alvim 1800 U-203m/c ROI frame rates

## Alvium 1800 U-234m/c

Feature	Specification	
	1800 U-234m	1800 U-234c
Sensor model	Sony IMX249	
Resolution	1936 (H) × 1216 (V); 2.35 MP	
Sensor type	CMOS	
Shutter type	Global shutter (GS)	
Sensor size	Type 1/1.2; 11.3 mm × 7.1 mm; 13.4 mm diagonal	
Pixel size	5.86 μm × 5.86 μm	
CRA	0 deg	
Sensor bit depth (ADC)	10-bit, 12-bit; Adaptive (10-bit, 12-bit)	
Monochrome pixel formats	Mono8 (default), Mono10, Mono10p, Mono12, Mono12p	Mono8, Mono10, Mono10p, Mono12, Mono12p
YUV color pixel formats	Not applicable	YCbCr411_8_CbYYCrYY, YCbCr422_8_CbYCrY, YCbCr8_CbYCr
RGB color pixel formats	Not applicable	BGR8, RGB8 (default)
Raw color pixel formats	Not applicable	BayerRG8, BayerRG10, BayerRG10p, BayerRG12, BayerRG12p
Maximum frame rate	40 fps (at ≥200 MByte/s)	
Exposure time	34 μs to 10 s (200 MByte/s)	
Exposure modes	Timed	
Gain	0 dB to 48 dB; 0.1 dB increments	
Digital binning	Horizontal: 1 to 8 columns; Vertical: 1 to 8 rows	
Multiple ROI (H × V)	<i>Free</i>	
Image buffer (RAM)	256 KByte	
Non-volatile memory (Flash)	1024 KByte	
GPIOs	4 programmable GPIOs As direct inputs (push-pull): 0 to 5.5 VDC As direct outputs (push-pull): 0 to 3.3 VDC at 12 mA	
Power requirements	Power over USB; External power	
Power consumption (typical, at 5 VDC)	USB power: 2.1 W External power: 2.3 W	

Table 40: Alvium 1800 U-234m/c specifications (sheet 1 of 2)

Feature	Specification			
	<b>1800 U-234m/c</b>			
Storage temperature	-20 °C to +85 °C ambient temperature			
<b>Operating temperature</b>	<b>Hardware option</b>	<b>Housing</b>	<b>Cooling area<sup>1</sup></b>	<b>Mainboard<sup>2</sup></b>
	Bare board <sup>3</sup>	Not applicable	-20 °C to +85 °C	-20 °C to +85 °C
	Open housing <sup>4</sup>	-20 °C to +65 °C		
	Closed housing	-20 °C to +65 °C	Not applicable	
Relative humidity	0% to 80% (non-condensing)			
Digital interface	Micro-B USB 3.1 Gen 1 interface			
Camera controls	GenICam (GenICam Access)			
<sup>1</sup> See <a href="#">Mounting the heat sink</a> on page 259. <sup>2</sup> Output by <code>DeviceTemperature</code> <sup>3</sup> Ensure that the sensor is operated in the temperature range specified by the manufacturer. For any questions, please visit <a href="http://www.alliedvision.com/en/support">www.alliedvision.com/en/support</a> . <sup>4</sup> Temperature values must be observed for the housing <b>and</b> for the cooling area.				

Table 40: Alvium 1800 U-234m/c specifications (sheet 2 of 2)

### Absolute QE

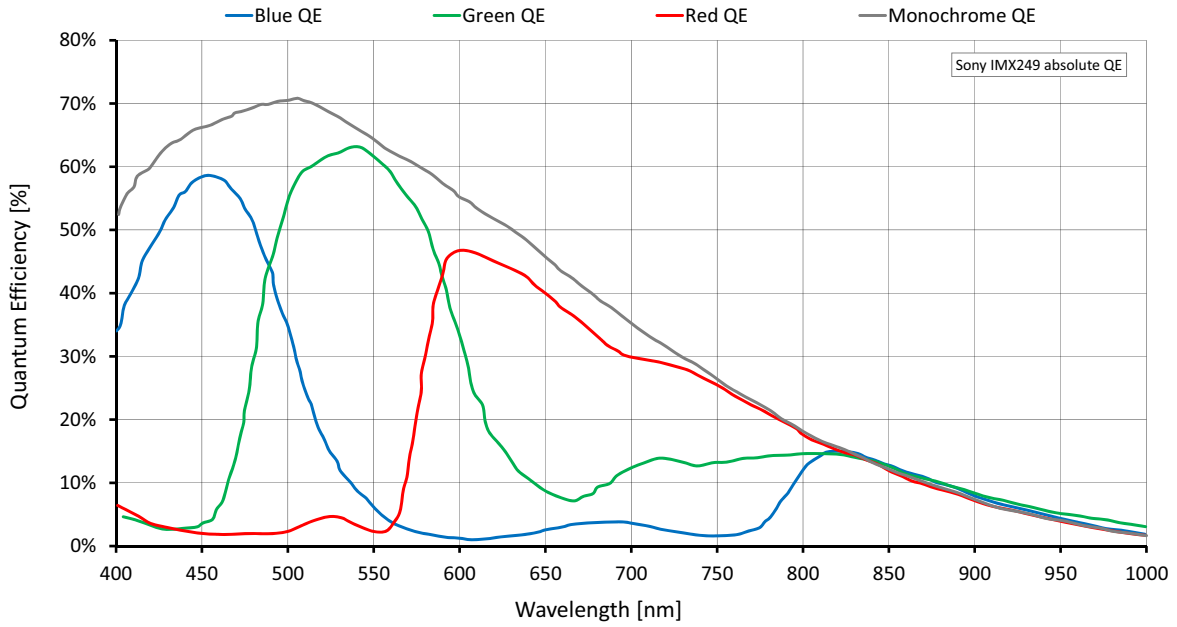

Figure 20: Alvium 1800 U-234m/c (Sony IMX249) absolute QE

### Spectral response

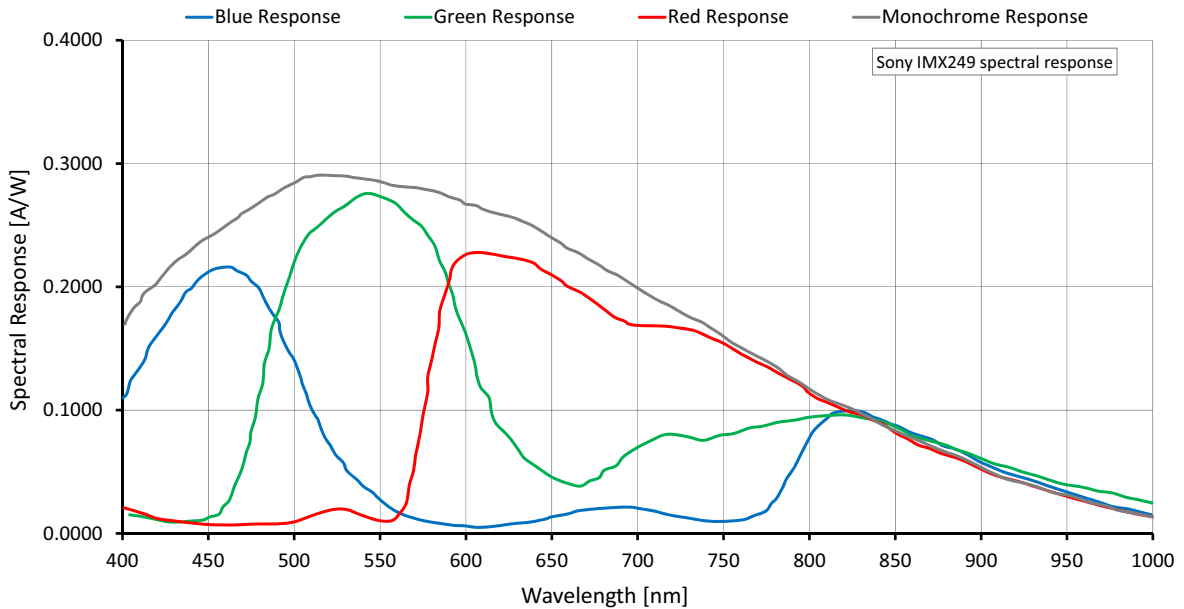

Figure 21: Alvium 1800 U-234m/c (Sony IMX249) spectral response



## ROI frame rates

Values were measured as defined in [Specified values](#) on page 67.

To reach the maximum frame rate available for this setup, the bandwidth for image traffic is 200 MByte/s. Increasing the `DeviceLinkThroughputLimit` value does not increase frame rates.

Image format	Width [pixels]	Height [pixels]	ROI area [MP]	Frame rate [fps] <sup>1</sup>		
				450 MByte/s	375 MByte/s	200 MByte/s
Full resolution	1936	1216	2.354	40.5/40.5/31.6		
Full HD	1920	1080	2.074	45.3/45.3/35.3		
UXGA	1600	1200	1.92	41.0/41.0/32.0		
WXGA+	1440	900	1.296	54.0/54.0/42.1		
SXGA	1280	1024	1.311	47.8/47.8/37.3		
HD 720	1280	720	0.922	66.6/66.6/51.9		
XGA	1024	768	0.786	62.7/62.7/48.9		
SVGA	800	600	0.48	79.1/79.1/61.6		
VGA	640	480	0.307	97.0/97.0/75.6		
HVGA	480	320	0.154	139.3/139.3/108.5		
QVGA	320	240	0.077	177.8/177.8/138.6		
HQVGA	240	160	0.038	245.9/245.9/192.5		
QQVGA	160	120	0.019	305.9/305.9/238.4		
Max. × half	1936	608	1.177	77.6/77.6/60.6		
Max. × min.	1936	8	0.015	828.8/828.8/656.5		
Min. × max.	8	1216	0.01	40.7/40.7/31.7		
Min. × min.	8	8	64 P	917.6/917.6/715.1		

<sup>1</sup> Mono8 or Mono10, or Bayer...8<sup>(2)</sup> or Bayer...10 at `SensorBitDepth` = 10-Bit<sup>(3)</sup> / Mono12 or Bayer...12 at `SensorBitDepth` = 12-Bit

<sup>2</sup> The three dots... represent the colors of a Bayer pixel format, such as in BayerRG8.

<sup>3</sup> The `SensorBitDepth` value must be set separately from `PixelFormat`.

See [Sensor ADC readout modes for maximum frame rates](#) on page 68 for details.

Table 41: Alvium 1800 U-234m/c ROI frame rates

## Alvium 1800 U-235m/c

Feature	Specification	
	1800 U-235m	1800 U-235c
Sensor model	Sony IMX174	
Resolution	1936 (H) × 1216 (V); 2.35 MP	
Sensor type	CMOS	
Shutter type	Global shutter (GS)	
Sensor size	Type 1/1.2; 11.3 mm × 7.1 mm; 13.4 mm diagonal	
Pixel size	5.86 μm × 5.86 μm	
CRA	0 deg	
Sensor bit depth (ADC)	10-bit, 12-bit; Adaptive (10-bit, 12-bit)	
Monochrome pixel formats	Mono8 (default), Mono10, Mono10p, Mono12, Mono12p	Mono8, Mono10, Mono10p, Mono12, Mono12p
YUV color pixel formats	Not applicable	YCbCr411_8_CbYYCrYY, YCbCr422_8_CbYCrY, YCbCr8_CbYCr
RGB color pixel formats	Not applicable	BGR8, RGB8 (default)
Raw color pixel formats	Not applicable	BayerRG8, BayerRG10, BayerRG10p, BayerRG12, BayerRG12p
Maximum frame rate	155 fps (at 450 MByte/s)	
Exposure time	19 μs to 10 s (450 MByte/s)	
Exposure modes	Timed	
Gain	0 dB to 48 dB; 0.1 dB increments	
Digital binning	Horizontal: 1 to 8 columns; Vertical: 1 to 8 rows	
Multiple ROI (H × V)	<i>Free</i>   <i>Tile</i>   <i>Horizontal</i> : 1 × 1 to 1 × 4   <i>Vertical</i> : 1 × 1 to 4 × 1	
Image buffer (RAM)	256 KByte	
Non-volatile memory (Flash)	1024 KByte	
GPIOs	4 programmable GPIOs As direct inputs (push-pull): 0 to 5.5 VDC As direct outputs (push-pull): 0 to 3.3 VDC at 12 mA	
Power requirements	Power over USB; External power	
Power consumption (typical, at 5 VDC)	USB power: 2.8 W External power: 3.0 W	

Table 42: Alvium 1800 U-235m/c specifications (sheet 1 of 2)

Feature	Specification			
	<b>1800 U-235m/c</b>			
Storage temperature	-20 °C to +85 °C ambient temperature			
<b>Operating temperature</b>	<b>Hardware option</b>	<b>Housing</b>	<b>Cooling area<sup>1</sup></b>	<b>Mainboard<sup>2</sup></b>
	Bare board <sup>3</sup>	Not applicable	-20 °C to +85 °C	-20 °C to +85 °C
	Open housing <sup>4</sup>	-20 °C to +65 °C		
	Closed housing	-20 °C to +65 °C	Not applicable	
Relative humidity	0% to 80% (non-condensing)			
Digital interface	Micro-B USB 3.1 Gen 1 interface			
Camera controls	GenICam (GenICam Access)			
<sup>1</sup> See <a href="#">Mounting the heat sink</a> on page 259. <sup>2</sup> Output by <code>DeviceTemperature</code> <sup>3</sup> Ensure that the sensor is operated in the temperature range specified by the manufacturer. For any questions, please visit <a href="http://www.alliedvision.com/en/support">www.alliedvision.com/en/support</a> . <sup>4</sup> Temperature values must be observed for the housing <b>and</b> for the cooling area.				

Table 42: Alvium 1800 U-235m/c specifications (sheet 2 of 2)

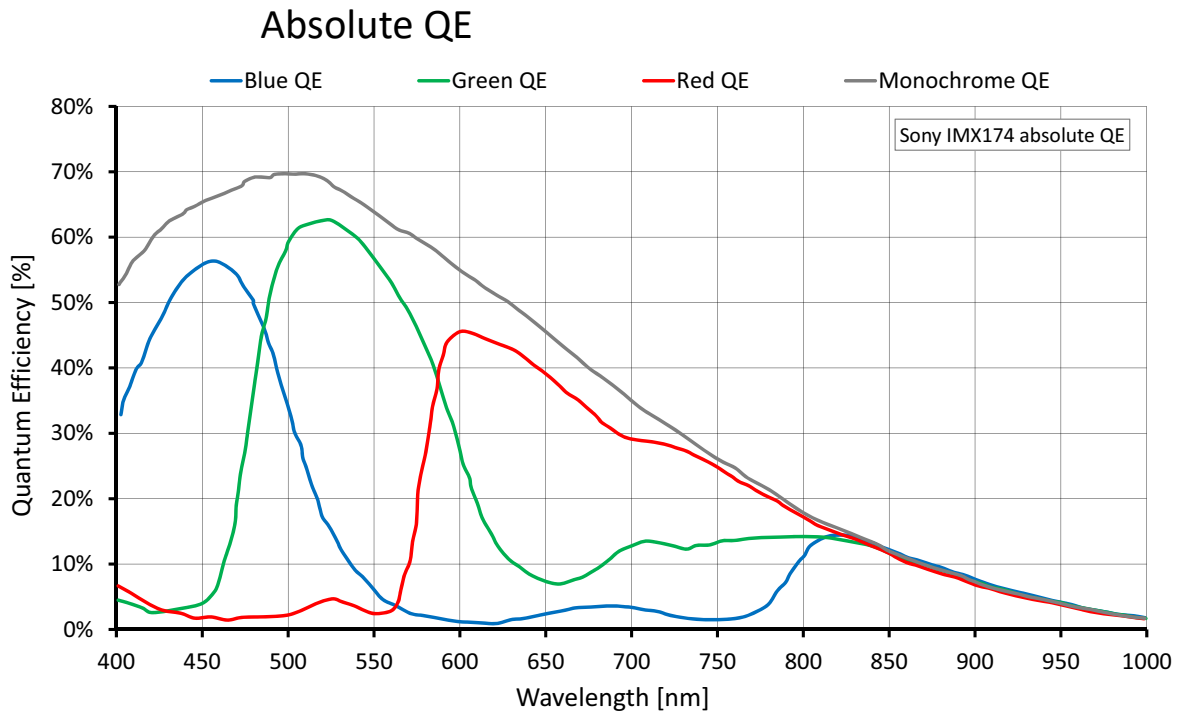

Figure 22: Alvim 1800 U-235m/c (Sony IMX174) absolute QE

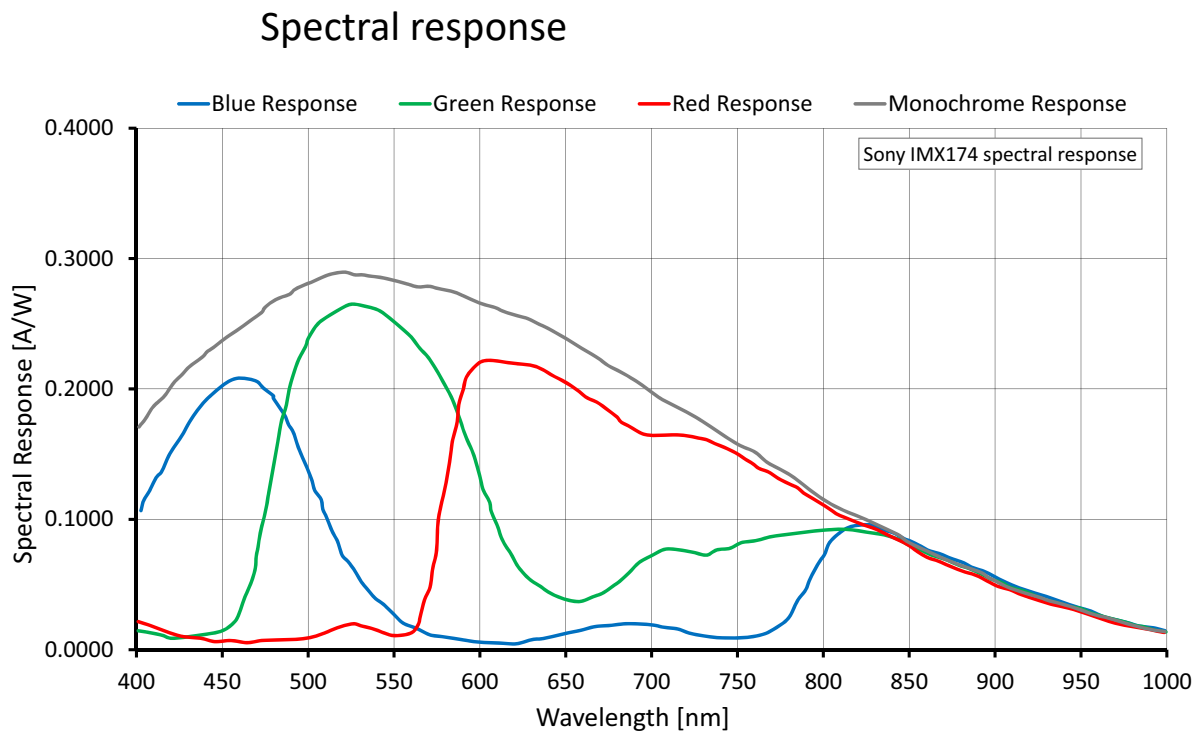

Figure 23: Alvim 1800 U-235m/c (Sony IMX174) spectral response

## ROI frame rates

Values were measured as defined in [Specified values](#) on page 67.

To reach the maximum frame rate available for this setup, the bandwidth for image traffic is 450 MByte/s.

Image format	Width [pixels]	Height [pixels]	ROI area [MP]	Frame rate [fps] <sup>1</sup>		
				450 MByte/s	375 MByte/s	200 MByte/s
Full resolution	1936	1216	2.354	155.9/88.8/88.8	148.0/75.2/75.1	80.3/40.5/40.4
Full HD	1920	1080	2.074	174.0/100.8/100.0	165.4/85.2/84.7	90.5/45.8/45.6
UXGA	1600	1200	1.92	158.7/109.2/109.0	158.7/92.3/91.9	98.3/49.6/49.6
WXGA+	1440	900	1.296	208.0/159.3/158.5	208.0/134.7/134.2	143.2/72.4/72.0
SXGA	1280	1024	1.311	185.1/157.7/144.6	185.1/133.4/133.0	143.0/72.2/71.8
HD 720	1280	720	0.922	255.9/218.3/200.1	255.9/185.0/184.1	198.1/100.5/99.8
XGA	1024	768	0.786	242.7/242.7/189.8	242.7/216.9/189.8	233.4/118.3/117.7
SVGA	800	600	0.48	305.9/305.9/238.9		305.9/189.6/189.4
VGA	640	480	0.307	375.3/375.3/293.3		375.3/290.5/286.5
HVGA	480	320	0.154	538.2/538.2/419.7		
QVGA	320	240	0.077	689.6/689.6/537.8		
HQVGA	240	160	0.038	955.0/955.0/744.8		
QQVGA	160	120	0.019	1182.7/1182.7/927.8		
Max. × half	1936	608	1.177	291.9/168.2/167.8	277.5/142.9/142.4	152.6/77.4/77.2
Max. × min.	1936	8	0.015	2097.1/1445.9/ 1380.5	2030.0/1285.7/ 1223.8	1356.9/781.2/ 758.3
Min. × max.	8	1216	0.01	160.7/160.7/125.3		
Min. × min.	8	8	64 P	3507.3/3507.3/ 2735.4		

<sup>1</sup> Mono8 or Bayer...8<sup>(2)</sup> at  $\text{SensorBitDepth} = 10\text{-Bit}^{(3)}$  /  
 Mono10 or Bayer...10<sup>(2)</sup> at  $\text{SensorBitDepth} = 10\text{-Bit}^{(3)}$  /  
 Mono12 or Bayer...12 at  $\text{SensorBitDepth} = 12\text{-Bit}$

<sup>2</sup> The three dots... represent the colors of a Bayer pixel format, such as in BayerRG8.

<sup>3</sup> The **SensorBitDepth** value must be set separately from **PixelFormat**.

See [Sensor ADC readout modes for maximum frame rates](#) on page 68 for details.

Table 43: Alvium 1800 U-235m/c ROI frame rates

## Alvium 1800 U-240m/c

Feature	Specification	
	1800 U-240m (monochrome)	1800 U-240c (color)
Sensor model	Sony IMX392	
Resolution	1936 (H) × 1216 (V); 2.4 MP	
Sensor type	CMOS	
Shutter type	Global shutter (GS)	
Sensor size	Type 1/2.3; 6.7 mm × 4.2 mm; 7.9 mm diagonal	
Pixel size	3.45 μm × 3.45 μm	
CRA	0 deg	
Sensor bit depth (ADC)	8-bit, 10-bit, 12-bit; Adaptive (10-bit, 12-bit)	
Monochrome pixel formats	Mono8 (default), Mono10, Mono10p, Mono12, Mono12p	Mono8, Mono10, Mono10p, Mono12, Mono12p
YUV color pixel formats	Not applicable	YCbCr411_8_CbYYCrYY, YCbCr422_8_CbYCrY, YCbCr8_CbYCr
RGB color pixel formats	Not applicable	BGR8, RGB8 (default)
Raw color pixel formats	Not applicable	BayerRG8, BayerRG10, BayerRG10p, BayerRG12, BayerRG12p
Maximum frame rate	176 fps (at 450 MByte/s)	
Exposure time	23 μs to 10 s (450 MByte/s)	
Exposure modes	Timed, TriggerControlled, TriggerWidth	
Gain	0 dB to 48 dB; 0.1 dB increments	
Digital binning	Horizontal: 1 to 8 columns; Vertical: 1 to 8 rows	
Sensor binning (H × V)	2 × 2 ( <i>Sum</i> )	Not applicable
Multiple ROI (H × V)	<i>Free</i>   <i>Tile</i>	
Image buffer (RAM)	256 KByte	
Non-volatile memory (Flash)	1024 KByte	
GPIOs	4 programmable GPIOs As direct inputs (push-pull): 0 to 5.5 VDC As direct outputs (push-pull): 0 to 3.3 VDC at 12 mA	
Power requirements	Power over USB; External power	
Power consumption (typical, at 5 VDC)	USB power: 2.8 W External power: 3.0 W	

Table 44: Alvium 1800 U-240m/c specifications (sheet 1 of 2)

Feature	Specification			
	<b>1800 U-240m/c</b>			
Storage temperature	-20 °C to +85 °C ambient temperature			
<b>Operating temperature</b>	<b>Hardware option</b>	<b>Housing</b>	<b>Cooling area<sup>1</sup></b>	<b>Mainboard<sup>2</sup></b>
	Bare board <sup>3</sup>	Not applicable	-20 °C to +85 °C	-20 °C to +85 °C
	Open housing <sup>4</sup>	-20 °C to +65 °C		
	Closed housing	-20 °C to +65 °C	Not applicable	
Relative humidity	0% to 80% (non-condensing)			
Digital interface	Micro-B USB 3.1 Gen 1 interface			
Camera controls	GenICam (GenICam Access)			
<sup>1</sup> See <a href="#">Mounting the heat sink</a> on page 259. <sup>2</sup> Output by DeviceTemperature <sup>3</sup> Ensure that the sensor is operated in the temperature range specified by the manufacturer. For any questions, please visit <a href="http://www.alliedvision.com/en/support">www.alliedvision.com/en/support</a> . <sup>4</sup> Temperature values must be observed for the housing <b>and</b> for the cooling area.				

Table 44: Alvium 1800 U-240m/c specifications (sheet 2 of 2)

### Absolute QE

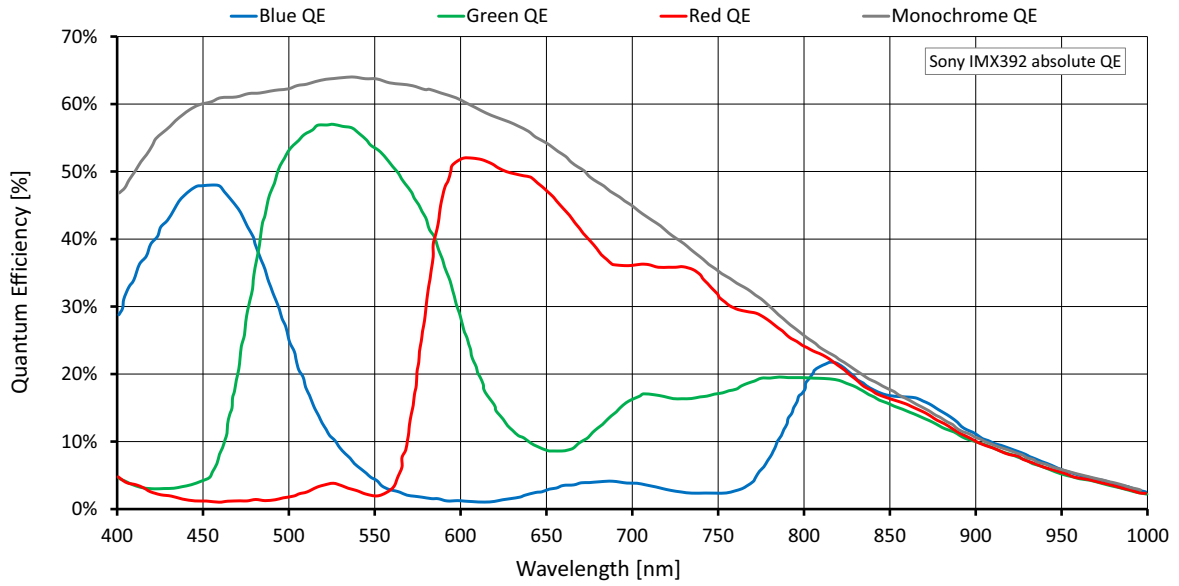

Figure 24: Alvium 1800 U-240m/c (Sony IMX392) absolute QE

### Spectral response

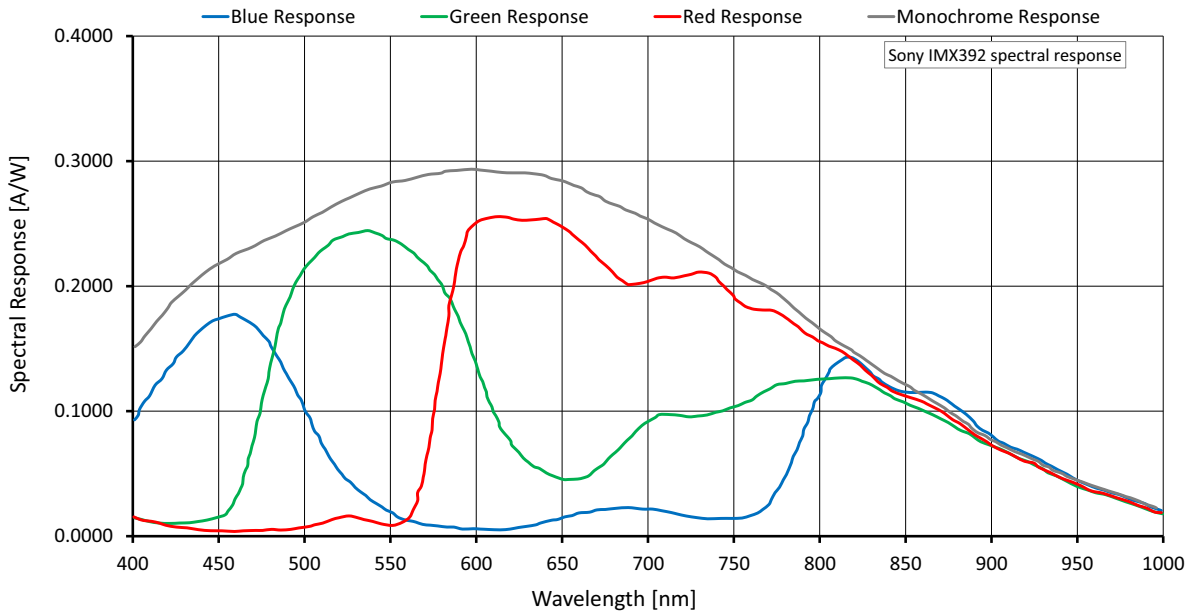

Figure 25: Alvium 1800 U-240m/c (Sony IMX392) spectral response



## ROI frame rates

Values were measured as defined in [Specified values](#) on page 67.

To reach the maximum frame rate available for this setup, the bandwidth for image traffic is 450 MByte/s.

Image format	Width [pixels]	Height [pixels]	ROI area [MP]	Frame rate [fps] <sup>1</sup>		
				450 MByte/s	375 MByte/s	200 MByte/s
Full resolution	1936	1216	2.354	176.0/88.9/89.0	149.3/75.3/75.4	80.6/40.5/40.5
Full HD	1920	1080	2.074	199.0/101.0/100.4	166.8/85.3/85.0	90.6/45.9/45.8
UXGA	1600	1200	1.92	195.5/109.4/109.3	181.3/92.4/92.1	98.6/49.7/49.8
WXGA+	1440	900	1.296	256.0/159.6/159.1	256.0/135.0/134.7	143.7/72.6/72.3
SXGA	1280	1024	1.311	227.8/158.0/152.7	227.8/133.7/133.4	143.4/72.4/72.1
HD 720	1280	720	0.922	314.7/218.9/211.4	314.7/185.5/185.0	199.0/100.7/100.3
XGA	1024	768	0.786	299.0/246.4/200.8	299.0/217.4/200.8	234.6/118.6/118.3
SVGA	800	600	0.48	376.1/310.6/253.0		371.1/190.2/190.5
VGA	640	480	0.307	461.1/381.2/310.8		461.1/291.6/288.6
HVGA	480	320	0.154	658.4/547.1/447.1		
QVGA	320	240	0.077	833.4/701.5/574.7		
HQVGA	240	160	0.038	1135.0/968.3/796.3		
QQVGA	160	120	0.019	1385.9/1192.2/983.7		
Max. × half	1936	608	1.177	330.2/168.7/168.8	281.5/143.3/143.2	153.5/77.7/77.7
Max. × min.	1936	8	0.015	2438.0/1483.5/ 1450.4	2222.5/1320.9/ 1289.1	1432.3/805.7/ 805.7
Min. × max.	8	1216	0.01	196.4/162.5/132.1		
Min. × min.	8	8	64 P	3635.5/3381.1/2883.3		

<sup>1</sup> Mono8 or Bayer...8<sup>(2)</sup> at **SensorBitDepth** = 8-Bit<sup>(3)</sup> /  
 Mono10 or Bayer...10 at **SensorBitDepth** = 10-Bit /  
 Mono12 or Bayer...12 at **SensorBitDepth** = 12-Bit

<sup>2</sup> The three dots... represent the colors of a Bayer pixel format, such as in BayerRG8.

<sup>3</sup> The **SensorBitDepth** value must be set separately from **PixelFormat**.  
 See [Sensor ADC readout modes for maximum frame rates](#) on page 68 for details.

Table 45: Alvium 1800 U-240m/c ROI frame rates

## Alvium 1800 U-291m/c

Feature	Specification	
	1800 U-291m (monochrome)	1800 U-291c (color)
Sensor model	Sony IMX421	
Resolution	1944 (H) x 1472 (V); 2.9 MP	
Sensor type	CMOS	
Shutter type	Global shutter (GS)	
Sensor size	Type 2/3; 8.8 mm x 6.6 mm; 10.8 mm diagonal	
Pixel size	4.5 μm x 4.5 μm	
CRA	0 deg	
Sensor bit depth (ADC)	8-bit, 10-bit, 12-bit; Adaptive (10-bit, 12-bit)	
Monochrome pixel formats	Mono8 (default), Mono10, Mono10p, Mono12, Mono12p	Mono8, Mono10, Mono10p, Mono12, Mono12p
YUV color pixel formats	Not applicable	YCbCr411_8_CbYYCrYY, YCbCr422_8_CbYCrY, YCbCr8_CbYCr
RGB color pixel formats	Not applicable	BGR8, RGB8 (default)
Raw color pixel formats	Not applicable	BayerRG8, BayerRG10, BayerRG10p, BayerRG12, BayerRG12p
Maximum frame rate	144 fps (at 450 MByte/s)	
Exposure time	14 μs to 10 s (450 MByte/s)	
Exposure modes	Timed, TriggerControlled, TriggerWidth	
Gain	0 dB to 48 dB; 0.1 dB increments	
Digital binning	Horizontal: 1 to 8 columns; Vertical: 1 to 8 rows	
Sensor binning (H x V)	2 x 2 ( <i>Sum, Average</i> )	Not applicable
Multiple ROI (H x V)	<i>Free   Tile   Horizontal</i> : 1 x 1 to 1 x 4   <i>Vertical</i> : 1 x 1 to 4 x 1	
Image buffer (RAM)	256 KByte	
Non-volatile memory (Flash)	1024 KByte	
GPIOs	4 programmable GPIOs As direct inputs (push-pull): 0 to 5.5 VDC As direct outputs (push-pull): 0 to 3.3 VDC at 12 mA	
Power requirements	Power over USB; External power	
Power consumption (typical, at 5 VDC)	USB power: 4.0 W External power: 4.2 W	

Table 46: Alvium 1800 U-291m/c specifications (sheet 1 of 2)

Feature	Specification			
	<b>1800 U-291m/c</b>			
Storage temperature	-20 °C to +85 °C ambient temperature			
<b>Operating temperature</b>	<b>Hardware option</b>	<b>Housing</b>	<b>Cooling area<sup>1</sup></b>	<b>Mainboard<sup>2</sup></b>
	Bare board <sup>3</sup>	Not applicable	-20 °C to +85 °C	-20 °C to +85 °C
	Open housing <sup>4</sup>	-20 °C to +65 °C		
	Closed housing	-20 °C to +65 °C	Not applicable	
Relative humidity	0% to 80% (non-condensing)			
Digital interface	Micro-B USB 3.1 Gen 1 interface			
Camera controls	GenICam (GenICam Access)			
<sup>1</sup> See <a href="#">Mounting the heat sink</a> on page 259. <sup>2</sup> Output by DeviceTemperature <sup>3</sup> Ensure that the sensor is operated in the temperature range specified by the manufacturer. For any questions, please visit <a href="http://www.alliedvision.com/en/support">www.alliedvision.com/en/support</a> . <sup>4</sup> Temperature values must be observed for the housing <b>and</b> for the cooling area.				

Table 46: Alvium 1800 U-291m/c specifications (sheet 2 of 2)

## Absolute QE, spectral response

We intend to add diagrams in a future version of this document.

## ROI frame rates

Values were measured as defined in [Specified values](#) on page 67.

To reach the maximum frame rate available for this setup, the bandwidth for image traffic is 450 MByte/s.

Image format	Width [pixels]	Height [pixels]	ROI area [MP]	Frame rate [fps] <sup>1</sup>		
				450 MByte/s	375 MByte/s	200 MByte/s
Full resolution	1944	1472	2.862	144.3/72.8/73.0	121.0/61.6/61.3	65.5/33.0/33.0
Full HD	1920	1080	2.074	194.0/98.6/98.2	162.6/83.3/83.1	88.3/44.8/44.7
UXGA	1600	1200	1.92	201.7/107.0/107.1	177.1/90.4/90.3	96.3/48.6/48.8
WXGA+	1440	900	1.296	261.0/154.5/154.4	254.0/130.7/130.7	138.8/70.2/70.1
SXGA	1280	1024	1.311	234.3/154.0/153.2	234.3/130.3/130.3	139.5/70.5/70.4
HD 720	1280	720	0.922	320.3/211.3/210.1	320.3/179.1/179.1	191.6/97.2/97.0
XGA	1024	768	0.786	304.4/248.5/214.3	304.4/210.3/211.4	226.4/114.7/114.6
SVGA	800	600	0.48	379.9/315.1/268.1		355.1/182.4/183.3
VGA	640	480	0.307	462.0/383.1/326.9		462.0/277.2/275.2
HVGA	480	320	0.154	645.2/537.9/460.6		645.2/509.3/460.6
QVGA	320	240	0.077	810.9/676.1/580.8		
HQVGA	240	160	0.038	1077.9/906.1/782.6		
QQVGA	160	120	0.019	1299.9/1097.4/952.1		
Max. x half	1944	736	1.431	269.0/137.1/137.4	226.5/116.3/115.7	123.6/62.7/62.8
Max. x min.	1944	8	0.016	1848.1/1087.9/ 1081.0	1635.6/954.7/949.8	1005.4/558.5/570.5
Min. x max.	8	1472	0.012	170.7/141.1/119.7		
Min. x min.	8	8	64 P	2979.5/2599.7/ 2338.0	2979.5/2599.8/2338.0	

<sup>1</sup> Mono8 or Bayer...8<sup>(2)</sup> at **SensorBitDepth** = 8-Bit<sup>(3)</sup> /  
 Mono10 or Bayer...10 at **SensorBitDepth** = 10-Bit /  
 Mono12 or Bayer...12 at **SensorBitDepth** = 12-Bit

<sup>2</sup> The three dots... represent the colors of a Bayer pixel format, such as in BayerRG8.

<sup>3</sup> The **SensorBitDepth** value must be set separately from **PixelFormat**.

See [Sensor ADC readout modes for maximum frame rates](#) on page 68 for details.

Table 47: Alvium 1800 U-291m/c ROI frame rates

## Alvium 1800 U-319m/c

Feature	Specification	
	1800 U-319m (monochrome)	1800 U-319c (color)
Sensor model	Sony IMX265	
Resolution	2064 (H) × 1544 (V); 3.2 MP	
Sensor type	CMOS	
Shutter type	Global shutter (GS)	
Sensor size	Type 1/1.8; 7.1 mm × 5.3 mm; 8.9 mm diagonal	
Pixel size	3.45 μm × 3.45 μm	
CRA	0 deg	
Sensor bit depth (ADC)	12-bit	
Monochrome pixel formats	Mono8 (default), Mono10, Mono10p, Mono12, Mono12p	Mono8, Mono10, Mono10p, Mono12, Mono12p
YUV color pixel formats	Not applicable	YCbCr411_8_CbYYCrYY, YCbCr422_8_CbYCrY, YCbCr8_CbYCr
RGB color pixel formats	Not applicable	BGR8, RGB8 (default)
Raw color pixel formats	Not applicable	BayerRG8, BayerRG10, BayerRG10p, BayerRG12, BayerRG12p
Maximum frame rate	54 fps (at ≥200 MByte/s)	
Exposure time	26 μs to 10 s (200 MByte/s)	
Exposure modes	Timed, TriggerControlled, TriggerWidth	
Gain	0 dB to 48 dB; 0.1 dB increments	
Digital binning	Horizontal: 1 to 8 columns; Vertical: 1 to 8 rows	
Multiple ROI (H × V)	<i>Free</i>	
Image buffer (RAM)	256 KByte	
Non-volatile memory (Flash)	1024 KByte	
GPIOs	4 programmable GPIOs As direct inputs (push-pull): 0 to 5.5 VDC As direct outputs (push-pull): 0 to 3.3 VDC at 12 mA	
Power requirements	Power over USB; External power	
Power consumption (typical, at 5 VDC)	USB power: 2.2 W External power: 2.4 W	

Table 48: Alvium 1800 U-319m/c specifications (sheet 1 of 2)

Feature	Specification			
	<b>1800 U-319m/c</b>			
Storage temperature	-20 °C to +85 °C ambient temperature			
<b>Operating temperature</b>	<b>Hardware option</b>	<b>Housing</b>	<b>Cooling area<sup>1</sup></b>	<b>Mainboard<sup>2</sup></b>
	Bare board <sup>3</sup>	Not applicable	-20 °C to +85 °C	-20 °C to +85 °C
	Open housing <sup>4</sup>	-20 °C to +65 °C		
	Closed housing	-20 °C to +65 °C	Not applicable	
Relative humidity	0% to 80% (non-condensing)			
Digital interface	Micro-B USB 3.1 Gen 1 interface			
Camera controls	GenICam (GenICam Access)			

<sup>1</sup> See [Mounting the heat sink](#) on page 259.

<sup>2</sup> Output by DeviceTemperature

<sup>3</sup> Ensure that the sensor is operated in the temperature range specified by the manufacturer. For any questions, please visit [www.alliedvision.com/en/support](http://www.alliedvision.com/en/support).

<sup>4</sup> Temperature values must be observed for the housing **and** for the cooling area.

Table 48: Alvium 1800 U-319m/c specifications (sheet 2 of 2)

### Absolute QE

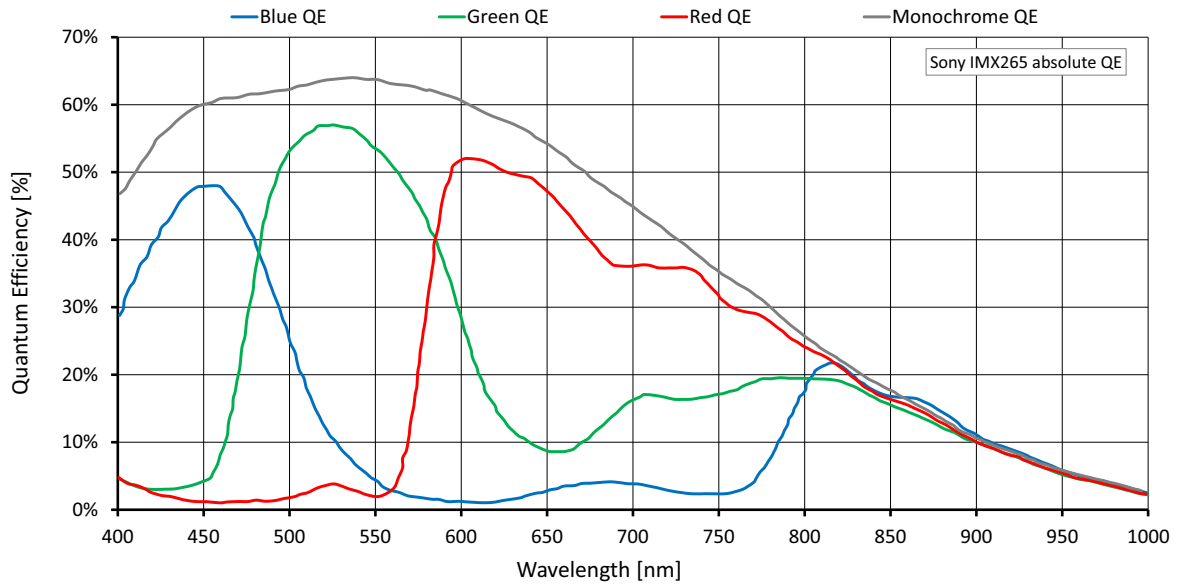

Figure 26: Alvium 1800 U-319m/c (Sony IMX265) absolute QE

### Spectral response

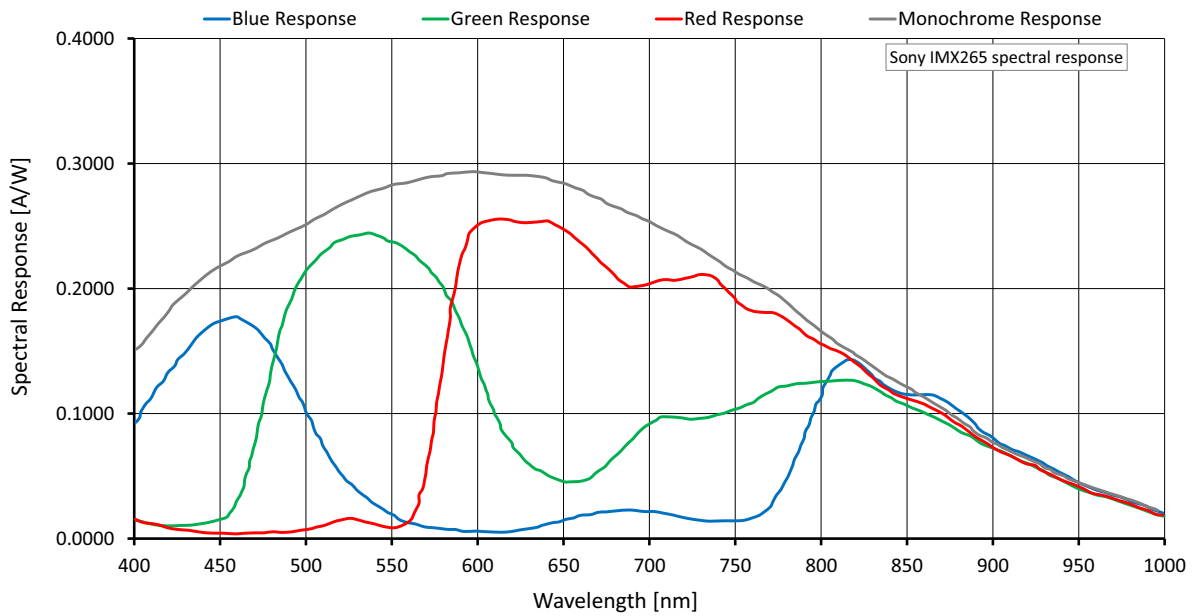

Figure 27: Alvium 1800 U-319m/c (Sony IMX265) spectral response

## ROI frame rates

Values were measured as defined in [Specified values](#) on page 67.

To reach the maximum frame rate available for this setup, the bandwidth for image traffic is 200 MByte/s. Increasing the `DeviceLinkThroughputLimit` value does not increase frame rates.

Image format	Width [pixels]	Height [pixels]	ROI area [MP]	Frame rate [fps] <sup>1</sup>		
				450 MByte/s	375 MByte/s	200 MByte/s
Full resolution	2064	1544	3.187	54.2/54.2		
QXGA	2048	1536	3.146	54.4/54.4		
Full HD	1920	1080	2.074	76.2/76.2		
UXGA	1600	1200	1.92	69.1/69.1		
WXGA+	1440	900	1.296	90.9/90.9		
SXGA	1280	1024	1.311	80.5/80.5		
HD 720	1280	720	0.922	112.0/112.0		
XGA	1024	768	0.786	105.9/105.9		
SVGA	800	600	0.48	133.5/133.5		
VGA	640	480	0.307	163.8/163.8		
HVGA	480	320	0.154	235.5/235.5		
QVGA	320	240	0.077	301.5/301.5		
HQVGA	240	160	0.038	419.0/419.0		
QQVGA	160	120	0.019	518.7/518.7		
Max. × half	2064	772	1.593	104.1/104.1		
Max. × min.	2064	8	0.017	1193.8/1193.8		
Min. × max.	8	1544	0.012	54.7/54.7		
Min. × min.	8	8	64 P	1556.2/1556.2		

<sup>1</sup> Mono8 or Bayer...8<sup>(2)</sup> at `SensorBitDepth` = 12-Bit / Mono12 or Bayer...12 at `SensorBitDepth` = 12-Bit

<sup>2</sup> The three dots... represent the colors of a Bayer pixel format, such as in BayerRG8.

Table 49: Alvim 1800 U-319m/c ROI frame rates



## Alvium 1800 U-320 VSWIR (coming soon)

Feature	Specification
	<b>1800 U-320 VSWIR</b>
Sensor model	Sony IMX993
Resolution	2080(H) × 1544 (V); 3.2 MP
Sensor type	InGaAs
Shutter type	Global shutter (GS)
Sensor size	Type 1/1.8; 7.2 mm × 5.3 mm; 8.9 mm diagonal
Pixel size	3.45 μm × 3.45 μm
CRA	Tbd
Sensor bit depth (ADC)	8-bit, 10-bit, 12-bit; Adaptive (10-bit, 12-bit)
Monochrome pixel formats	Mono8 (default), Mono10, Mono10p, Mono12, Mono12p
Maximum frame rate	125 fps (at 450 MByte/s)
Exposure time	25 μs to 10 s (450 MByte/s)
Exposure modes	Timed, TriggerControlled, TriggerWidth
Gain	0 dB to 42 dB; 0.1 dB increments
Digital binning	Horizontal: 1 to 8 columns; Vertical: 1 to 8 rows
Multiple ROI (H × V)	<i>Free   Tile   Horizontal</i> : 1 × 1 to 1 × 4   <i>Vertical</i> : 1 × 1 to 4 × 1
Image buffer (RAM)	256 KByte
Non-volatile memory (Flash)	1024 KByte
GPIOs	4 programmable GPIOs As direct inputs (push-pull): 0 to 5.5 VDC As direct outputs (push-pull): 0 to 3.3 VDC at 12 mA
Power requirements	Power over USB; External power
Power consumption (typical, at 5 VDC)	Tbd

Table 50: Alvium 1800 U-320 VSWIR specifications (sheet 1 of 2)

Feature	Specification			
	<b>1800 U-320 VSWIR</b>			
Storage temperature	-20 °C to +85 °C ambient temperature			
<b>Operating temperature</b>	<b>Hardware option</b>	<b>Housing</b>	<b>Cooling area<sup>1</sup></b>	<b>Mainboard<sup>2</sup></b>
	Bare board <sup>3</sup>	Not applicable	-20 °C to +85 °C	-20 °C to +85 °C
	Open housing <sup>4</sup>	-20 °C to +65 °C		
	Closed housing	-20 °C to +65 °C	Not applicable	
Relative humidity	0% to 80% (non-condensing)			
Digital interface	Micro-B USB 3.1 Gen 1 interface			
Camera controls	GenICam (GenICam Access)			
<sup>1</sup> See <a href="#">Mounting the heat sink</a> on page 259. <sup>2</sup> Output by DeviceTemperature <sup>3</sup> Ensure that the sensor is operated in the temperature range specified by the manufacturer. For any questions, please visit <a href="http://www.alliedvision.com/en/support">www.alliedvision.com/en/support</a> . <sup>4</sup> Temperature values must be observed for the housing <b>and</b> for the cooling area.				

Table 50: Alvium 1800 U-320 VSWIR specifications (sheet 2 of 2)

## Absolute QE, spectral response

We intend to add diagrams in a future version of this document.

## ROI frame rates

Values were measured as defined in [Specified values](#) on page 67.

To reach the maximum frame rate available for this setup, the bandwidth for image traffic is 450 MByte/s.

Image format	Width [pixels]	Height [pixels]	ROI area [MP]	Frame rate [fps] <sup>1</sup>		
				450 MByte/s	375 MByte/s	200 MByte/s
Full resolution	2080	1544	3.212	125.3 / 63.0 / 62.9	105.1 / 52.9 / 52.5	56.3 / 28.4 / 28.3
QXGA	2048	1536	3.146	127.4 / 64.3 / 64.3	106.6 / 53.8 / 53.6	57.4 / 28.9 / 28.9
Full HD	1920	1080	2.074	180.1 / 94.1 / 93.5	154.6 / 78.3 / 78.4	83.9 / 42.2 / 42.2
UXGA	1600	1200	1.920	165.1 / 102.8 / 102.8	165.1 / 86.0 / 85.7	91.9 / 46.2 / 46.2
WXGA+	1440	900	1.296	211.2 / 145.0 / 140.9	211.2 / 121.5 / 120.8	130.7 / 65.8 / 65.5
SXGA	1280	1024	1.311	190.4 / 147.2 / 127.0	190.4 / 123.1 / 122.7	132.2 / 66.2 / 66.2
HD 720	1280	720	0.922	255.8 / 197.8 / 170.7	255.8 / 165.6 / 164.9	178.1 / 89.4 / 89.2
XGA	1024	768	0.786	243.9 / 200.0 / 162.8	243.9 / 195.4 / 162.8	209.3 / 105.7 / 105.9
SVGA	800	600	0.480	299.4 / 245.9 / 199.9		299.4 / 166.4 / 166.2
VGA	640	480	0.307	357.6 / 293.7 / 238.8		357.6 / 245.5 / 238.8
HVGA	480	320	0.154	481.6 / 395.8 / 321.8		
QVGA	320	240	0.077	584.9 / 480.9 / 391.0		
HQVGA	240	160	0.038	739.8 / 608.6 / 496.4		
QQVGA	160	120	0.019	857.5 / 705.8 / 573.8		
Max. x half	2080	772	1.606	226.2 / 114.6 / 114.0	190.3 / 96.3 / 95.5	102.7 / 51.9 / 51.7
Max. x min.	2080	8	0.017	1160.5 / 629.3 / 611.4	1006.8 / 538.9 / 524.4	583.4 / 304.2 / 299.8
Min. x max.	8	1544	0.012	134.3 / 110.2 / 89.6		
Min. x min.	8	8	64 P	1519.3 / 1254.2 / 1019.7		

<sup>1</sup> Mono8 at  $\text{SensorBitDepth} = 8\text{-Bit}^{(2)}$  / Mono10 at  $\text{SensorBitDepth} = 10\text{-Bit}$  / Mono12 or at  $\text{SensorBitDepth} = 12\text{-Bit}$

<sup>2</sup> The  $\text{SensorBitDepth}$  value must be set separately from  $\text{PixelFormat}$ .  
See [Sensor ADC readout modes for maximum frame rates](#) on page 68 for details.

Table 51: Alvium 1800 U-320 VSWIR ROI frame rates (calculated values)

## Alvium 1800 U-500m/c

Feature	Specification	
	1800 U-500m (monochrome)	1800 U-500c (color)
Sensor model	ON Semiconductor AR0521SR	
Resolution	2592 (H) × 1944 (V); 5.0 MP	
Sensor type	CMOS	
Shutter type	Rolling shutter (RS)	
Sensor size	Type 1/2.5; 5.7 mm × 4.3 mm; 7.1 mm diagonal	
Pixel size	2.2 μm × 2.2 μm	
CRA	9 deg	
Sensor bit depth (ADC)	10-bit	
Monochrome pixel formats	Mono8 (default), Mono10, Mono10p, Mono12, Mono12p	Mono8, Mono10, Mono10p, Mono12, Mono12p
YUV color pixel formats	Not applicable	YCbCr411_8_CbYYCrYY, YCbCr422_8_CbYCrY, YCbCr8_CbYCr
RGB color pixel formats	Not applicable	BGR8, RGB8 (default)
Raw color pixel formats	Not applicable	BayerGR8, BayerGR10, BayerGR10p, BayerGR12, BayerGR12p
Maximum frame rate	68 fps <sup>1</sup> (at ≥375 MByte/s)	
Exposure time	8 μs to 10 s (375 MByte/s)	
Exposure modes	Timed	
Gain	0 dB to 24.1 dB; 0.1 dB increments	
Digital binning	Horizontal: 1 to 8 columns; Vertical: 1 to 8 rows	
Sensor binning (H × V)	2 × 1, 4 × 1 ( <i>Sum</i> )	
Image buffer (RAM)	256 KByte	
Non-volatile memory (Flash)	1024 KByte	
GPIOs	4 programmable GPIOs As direct inputs (push-pull): 0 to 5.5 VDC As direct outputs (push-pull): 0 to 3.3 VDC at 12 mA	
Power requirements	Power over USB; External power	
Power consumption (typical at 5 VDC)	USB power: 2.2 W External power: 2.4 W	
<sup>1</sup> In triggered mode: ~34 fps		

Table 52: Alvium 1800 U-500m/c specifications (sheet 1 of 2)

Feature	Specification			
	<b>1800 U-500m/c</b>			
Storage temperature	-20 °C to +85 °C ambient temperature			
<b>Operating temperature</b>	<b>Hardware option</b>	<b>Housing</b>	<b>Cooling area<sup>2</sup></b>	<b>Mainboard<sup>3</sup></b>
	Bare board <sup>4</sup>	Not applicable	-20 °C to +85 °C	-20 °C to +85 °C
	Open housing <sup>5</sup>	-20 °C to +65 °C		
	Closed housing	-20 °C to +65 °C	Not applicable	
Relative humidity	0% to 80% (non-condensing)			
Digital interface	Micro-B USB 3.1 Gen 1 interface			
Camera controls	GenICam (GenICam Access)			
<sup>2</sup> See <a href="#">Mounting the heat sink</a> on page 259. <sup>3</sup> Output by DeviceTemperature <sup>4</sup> Ensure that the sensor is operated in the temperature range specified by the manufacturer. For any questions, please visit <a href="http://www.alliedvision.com/en/support">www.alliedvision.com/en/support</a> . <sup>5</sup> Temperature values must be observed for the housing <b>and</b> for the cooling area.				

Table 52: Alvium 1800 U-500m/c specifications (sheet 2 of 2)

### Absolute QE

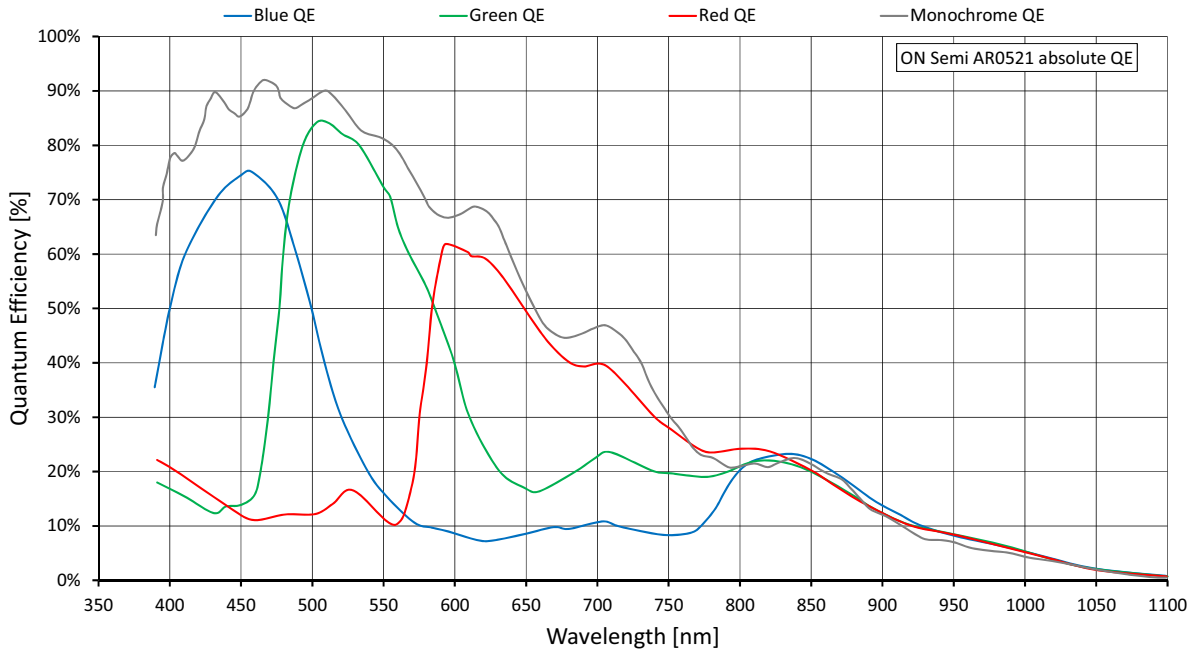

Figure 28: Alvium 1800 U-500m/c (ON Semi AR0521SR) absolute QE

### Spectral response

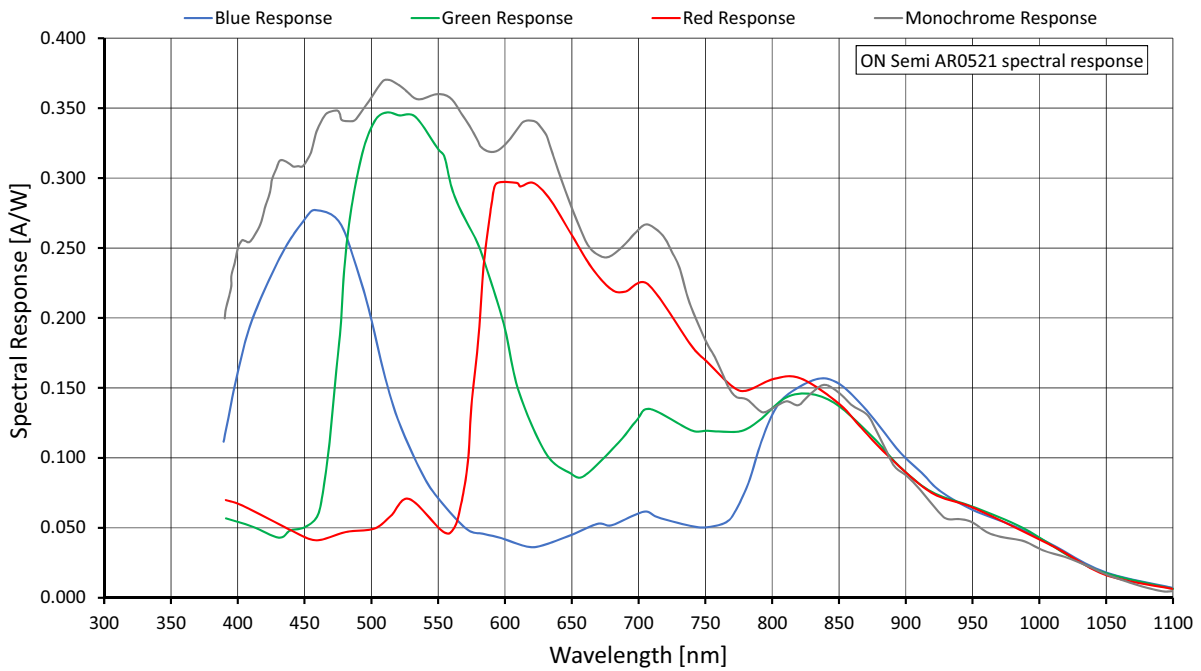

Figure 29: Alvium 1800 U-500m/c (ON Semi AR0521SR) spectral response

## ROI frame rates

Values were measured as defined in [Specified values](#) on page 67.

To reach the maximum frame rate available for this setup, the bandwidth for image traffic is 375 MByte/s. Increasing the `DeviceLinkThroughputLimit` value does not increase frame rates.

Shutter mode	User mode	Available frame rates
Rolling shutter (RS)	Freerun	Values in <a href="#">Table 54</a> below are reached.
Rolling shutter (RS)	Triggered	>50% of the values for in <a href="#">Table 54</a> below are reached.

Table 53: Frame rate behavior for different configurations

Image format	Width [pixels]	Height [pixels]	ROI area [MP]	Frame rate [fps] <sup>1</sup>		
				450 MByte/s	375 MByte/s	200 MByte/s
Full resolution	2592	1944	5.039	68.2/43.2	68.2/36.4	38.8/19.5
WQHD	2560	1440	3.686	91.1/58.5	91.1/49.4	52.6/26.4
QXGA	2048	1536	3.146	85.9/68.7	85.9/57.9	61.8/31.0
Full HD	1920	1080	2.074	120.6/102.9	120.6/86.9	92.6/46.5
UXGA	1600	1200	1.92	109.2/109.2	109.2/94.1	100.3/50.4
WXGA+	1440	900	1.296	143.9/143.9	143.9/137.9	143.9/73.9
SXGA	1280	1024	1.311	127.4/127.4		127.4/73.5
HD 720	1280	720	0.922	178.0/178.0		178.0/102.8
XGA	1024	768	0.786	167.9/167.9		167.9/120.8
SVGA	800	600	0.48	212.4/212.4		212.4/195.2
VGA	640	480	0.307	261.9/261.9		
HVGA	480	320	0.154	379.3/379.3		
QVGA	320	240	0.077	489.7/489.7		
HQVGA	240	160	0.038	687.5/687.5		
QQVGA	160	120	0.019	861.5/861.5		
Max. × half	2592	972	2.519	132.7/84.4	132.7/71.2	75.8/38.1
Max. × min.	2592	8	0.021	2194.0/1561.7	2194.0/1364.6	1428.2/787.8
Min. × max.	8	1944	0.016	68.7/68.7		
Min. × min.	8	8	64 P	2956.0/2956.0		

<sup>1</sup> Mono8 or Bayer...8<sup>(2)</sup> at `SensorBitDepth` = 10-Bit /  
Mono10 or Bayer...10 at `SensorBitDepth` = 10-Bit

<sup>2</sup> The three dots... represent the colors of a Bayer pixel format, such as in BayerRG8.

Table 54: Alvium 1800 U-500m/c ROI frame rates

## Alvium 1800 U-501m/c NIR

Feature	Specification	
	1800 U-501m NIR (monochrome)	1800 U-501c NIR (color)
Sensor model	ON Semiconductor AR0522	
Resolution	2592 (H) × 1944 (V); 5.0 MP	
Sensor type	CMOS	
Shutter type	Rolling shutter (RS)	
Sensor size	Type 1/2.5; 5.7 mm × 4.3 mm; 7.1 mm diagonal	
Pixel size	2.2 μm × 2.2 μm	
CRA	9 deg	
Sensor bit depth (ADC)	10-bit	
Monochrome pixel formats	Mono8 (default), Mono10, Mono10p, Mono12, Mono12p	Mono8, Mono10, Mono10p, Mono12, Mono12p
YUV color pixel formats	Not applicable	YCbCr411_8_CbYYCrYY, YCbCr422_8_CbYCrY, YCbCr8_CbYCr
RGB color pixel formats	Not applicable	BGR8, RGB8 (default)
Raw color pixel formats	Not applicable	BayerGR8, BayerGR10, BayerGR10p, BayerGR12, BayerGR12p
Maximum frame rate	68 fps <sup>1</sup> (at ≥375 MByte/s)	
Exposure time	8 μs to 10 s (375 MByte/s)	
Exposure modes	Timed	
Gain	0 dB to 24.1 dB; 0.1 dB increments	
Digital binning	Horizontal: 1 to 8 columns; Vertical: 1 to 8 rows	
Sensor binning (H × V)	2 × 1, 4 × 1 ( <i>Sum</i> )	
Image buffer (RAM)	256 KByte	
Non-volatile memory (Flash)	1024 KByte	
GPIOs	4 programmable GPIOs As direct inputs (push-pull): 0 to 5.5 VDC As direct outputs (push-pull): 0 to 3.3 VDC at 12 mA	
Power requirements	Power over USB; External power	
Power consumption (typical at 5 VDC)	USB power: 2.2 W External power: 2.4 W	
<sup>1</sup> In triggered mode: ~34 fps		

Table 55: Alvium 1800 U-501m/c NIR specifications (sheet 1 of 2)



Feature	Specification			
	<b>1800 U-501m/c NIR (monochrome)</b>			
Storage temperature	-20 °C to +85 °C ambient temperature			
<b>Operating temperature</b>	<b>Hardware option</b>	<b>Housing</b>	<b>Cooling area<sup>2</sup></b>	<b>Mainboard<sup>3</sup></b>
	Bare board <sup>4</sup>	Not applicable	-20 °C to +85 °C	-20 °C to +85 °C
	Open housing <sup>5</sup>	-20 °C to +65 °C		
	Closed housing	-20 °C to +65 °C	Not applicable	
Relative humidity	0% to 80% (non-condensing)			
Digital interface	Micro-B USB 3.1 Gen 1 interface			
Camera controls	GenICam (GenICam Access)			
<sup>2</sup> See <a href="#">Mounting the heat sink</a> on page 259. <sup>3</sup> Output by DeviceTemperature <sup>4</sup> Ensure that the sensor is operated in the temperature range specified by the manufacturer. For any questions, please visit <a href="http://www.alliedvision.com/en/support">www.alliedvision.com/en/support</a> . <sup>5</sup> Temperature values must be observed for the housing <b>and</b> for the cooling area.				

Table 55: Alvium 1800 U-501m/c NIR specifications (sheet 2 of 2)

### Absolute QE

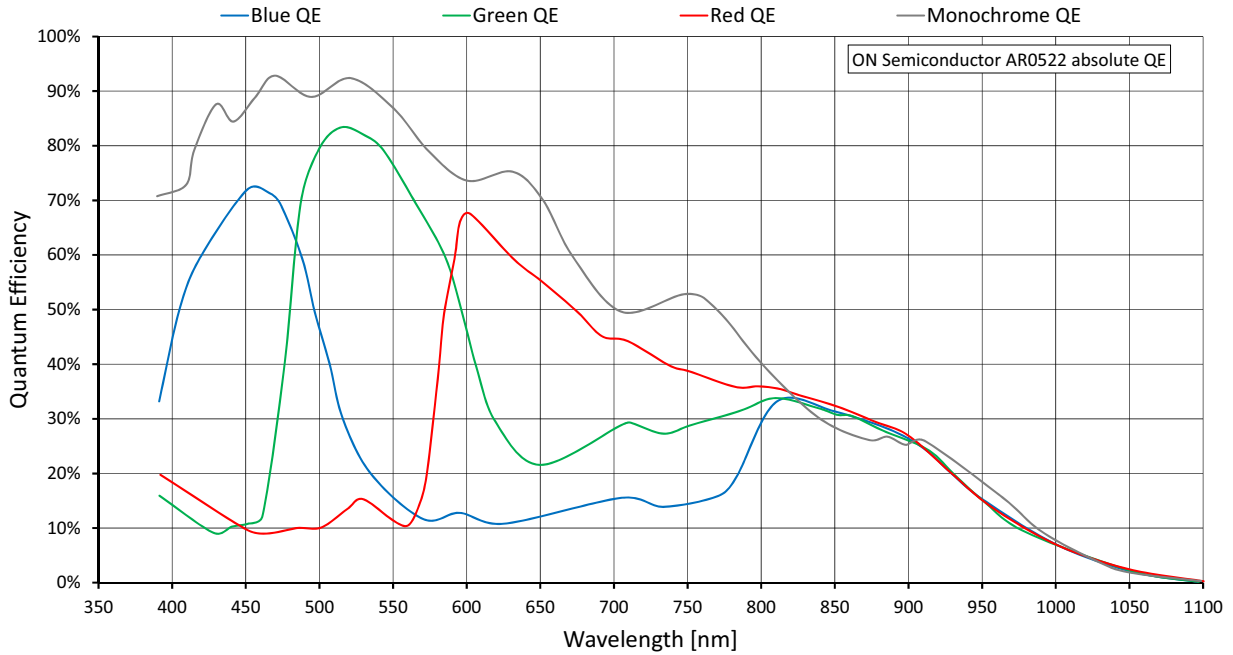

Figure 30: Alvium 1800 U-501m/c NIR (ON Semi AR0522) absolute QE

### Spectral response

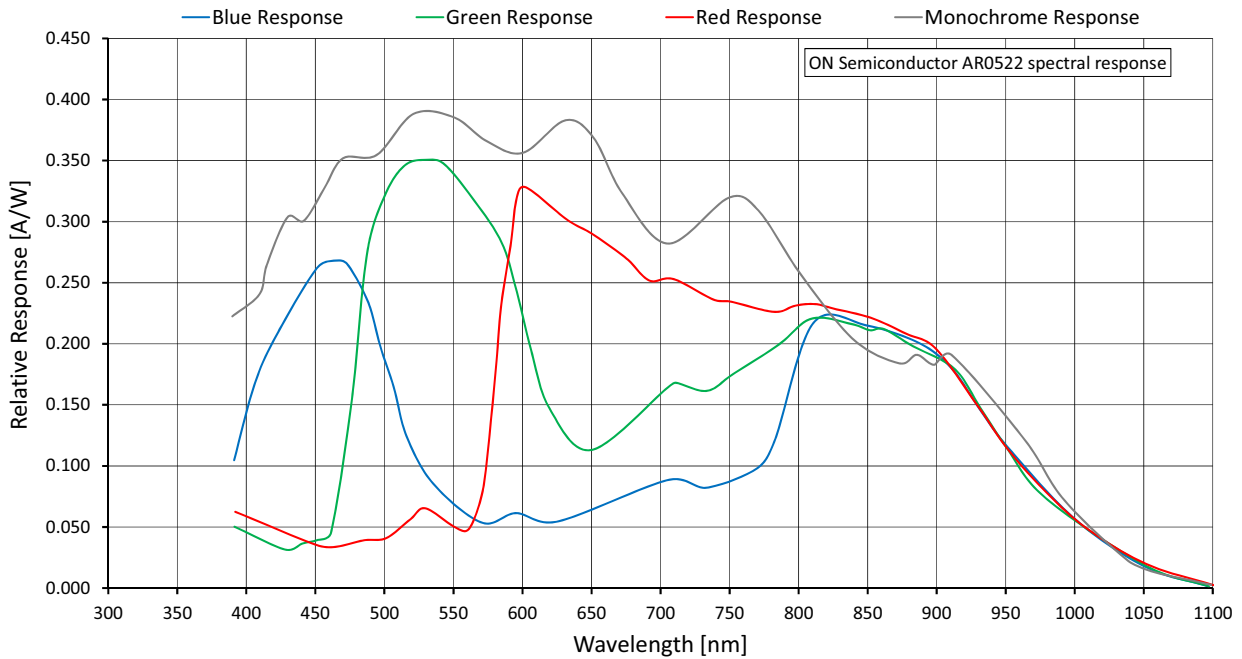

Figure 31: Alvium 1800 U-501m/c NIR (ON Semi AR0522) spectral response

## ROI frame rates

Values were measured as defined in [Specified values](#) on page 67.

To reach the maximum frame rate available for this setup, the bandwidth for image traffic is 375 MByte/s. Increasing the `DeviceLinkThroughputLimit` value does not increase frame rates.

Shutter mode	User mode	Available frame rates
Rolling shutter (RS)	Freerun	Values in <a href="#">Table 57</a> below are reached.
Rolling shutter (RS)	Triggered	>50% of the values for in <a href="#">Table 57</a> below are reached.

Table 56: Frame rate behavior for different configurations

Image format	Width [pixels]	Height [pixels]	ROI area [MP]	Frame rate [fps] <sup>1</sup>		
				450 MByte/s	375 MByte/s	200 MByte/s
Full resolution	2592	1944	5.039	68.2/43.2	68.2/36.4	38.8/19.5
WQHD	2560	1440	3.686	91.1/58.5	91.1/49.4	52.6/26.4
QXGA	2048	1536	3.146	85.9/68.7	85.9/57.9	61.8/31.0
Full HD	1920	1080	2.074	120.6/102.9	120.6/86.9	92.6/46.5
UXGA	1600	1200	1.92	109.2/109.2	109.2/94.1	100.3/50.4
WXGA+	1440	900	1.296	143.9/143.9	143.9/137.9	143.9/73.9
SXGA	1280	1024	1.311	127.4/127.4		127.4/73.5
HD 720	1280	720	0.922	178.0/178.0		178.0/102.8
XGA	1024	768	0.786	167.9/167.9		167.9/120.8
SVGA	800	600	0.48	212.4/212.4		212.4/195.2
VGA	640	480	0.307	261.9/261.9		
HVGA	480	320	0.154	379.3/379.3		
QVGA	320	240	0.077	489.7/489.7		
HQVGA	240	160	0.038	687.5/687.5		
QQVGA	160	120	0.019	861.5/861.5		
Max. × half	2592	972	2.519	132.7/84.4	132.7/71.2	75.8/38.1
Max. × min.	2592	8	0.021	2194.0/1561.7	2194.0/1364.6	1428.2/787.8
Min. × max.	8	1944	0.016	68.7/68.7		
Min. × min.	8	8	64 P	2956.0/2956.0		

<sup>1</sup> Mono8 or Bayer...8<sup>(2)</sup> at `SensorBitDepth` = 10-Bit /  
Mono10 or Bayer...10 at `SensorBitDepth` = 10-Bit

<sup>2</sup> The three dots... represent the colors of a Bayer pixel format, such as in BayerRG8.

Table 57: Alvium 1800 U-501m/c NIR ROI frame rates

## Alvium 1800 U-507m/c

Feature	Specification	
	1800 U-507m (monochrome)	1800 U-507c (color)
Sensor model	Sony IMX264	
Resolution	2464 (H) × 2056 (V); 5.1 MP	
Sensor type	CMOS	
Shutter type	Global shutter (GS)	
Sensor size	Type 2/3; 8.5 mm × 7.1 mm; 11.1 mm diagonal	
Pixel size	3.45 μm × 3.45 μm	
CRA	0 deg	
Sensor bit depth (ADC)	12-bit	
Monochrome pixel formats	Mono8 (default), Mono10, Mono10p, Mono12, Mono12p	Mono8, Mono10, Mono10p, Mono12, Mono12p
YUV color pixel formats	Not applicable	YCbCr411_8_CbYYCrYY, YCbCr422_8_CbYCrY, YCbCr8_CbYCr
RGB color pixel formats	Not applicable	BGR8, RGB8 (default)
Raw color pixel formats	Not applicable	BayerRG8, BayerRG10, BayerRG10p, BayerRG12, BayerRG12p
Maximum frame rate	34 fps (at ≥200 MByte/s)	
Exposure time	28 μs to 10 s (200 MByte/s)	
Exposure modes	Timed, TriggerControlled, TriggerWidth	
Gain	0 dB to 48 dB; 0.1 dB increments	
Digital binning	Horizontal: 1 to 8 columns; Vertical: 1 to 8 rows	
Multiple ROI (H × V)	<i>Free</i>	
Image buffer (RAM)	256 KByte	
Non-volatile memory (Flash)	1024 KByte	
GPIOs	4 programmable GPIOs As direct inputs (push-pull): 0 to 5.5 VDC As direct outputs (push-pull): 0 to 3.3 VDC at 12 mA	
Power requirements	Power over USB; External power	
Power consumption (typical, at 5 VDC)	USB power: 2.0 W External power: 2.2 W	

Table 58: Alvium 1800 U-507m/c specifications (sheet 1 of 2)

Feature	Specification			
	<b>1800 U-507m/c</b>			
Storage temperature	-20 °C to +85 °C ambient temperature			
<b>Operating temperature</b>	<b>Hardware option</b>	<b>Housing</b>	<b>Cooling area<sup>1</sup></b>	<b>Mainboard<sup>2</sup></b>
	Bare board <sup>3</sup>	Not applicable	-20 °C to +85 °C	-20 °C to +85 °C
	Open housing <sup>4</sup>	-20 °C to +65 °C		
	Closed housing	-20 °C to +65 °C	Not applicable	
Relative humidity	0% to 80% (non-condensing)			
Digital interface	Micro-B USB 3.1 Gen 1 interface			
Camera controls	GenICam (GenICam Access)			

<sup>1</sup> See [Mounting the heat sink](#) on page 259.

<sup>2</sup> Output by DeviceTemperature

<sup>3</sup> Ensure that the sensor is operated in the temperature range specified by the manufacturer. For any questions, please visit [www.alliedvision.com/en/support](http://www.alliedvision.com/en/support).

<sup>4</sup> Temperature values must be observed for the housing **and** for the cooling area.

Table 58: Alvium 1800 U-507m/c specifications (sheet 2 of 2)

### Absolute QE

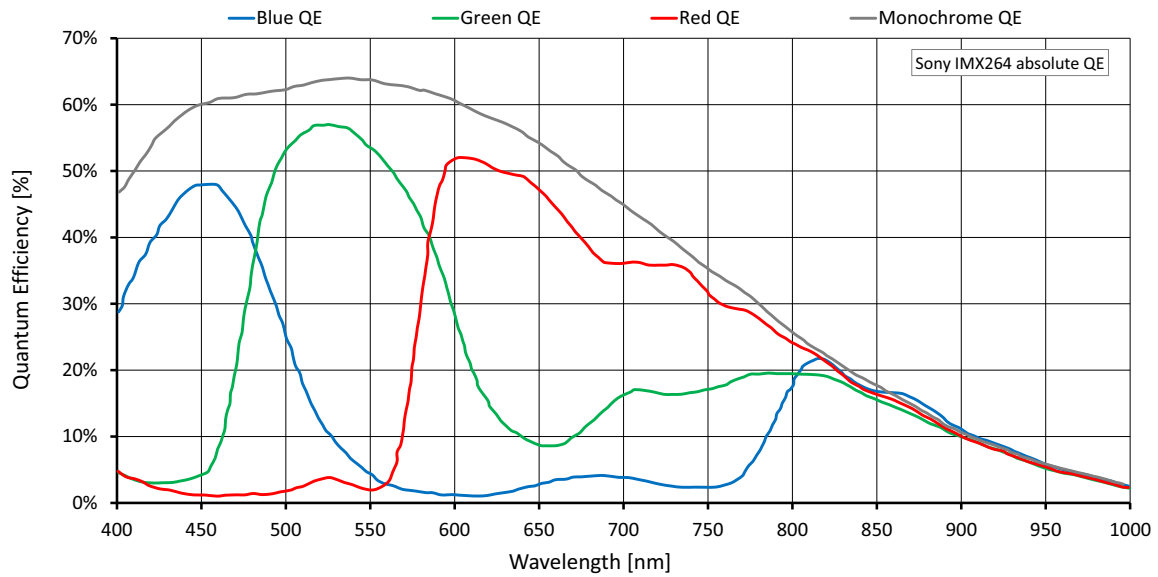

Figure 32: Alvim 1800 U-507m/c (Sony IMX264) absolute QE

### Spectral response

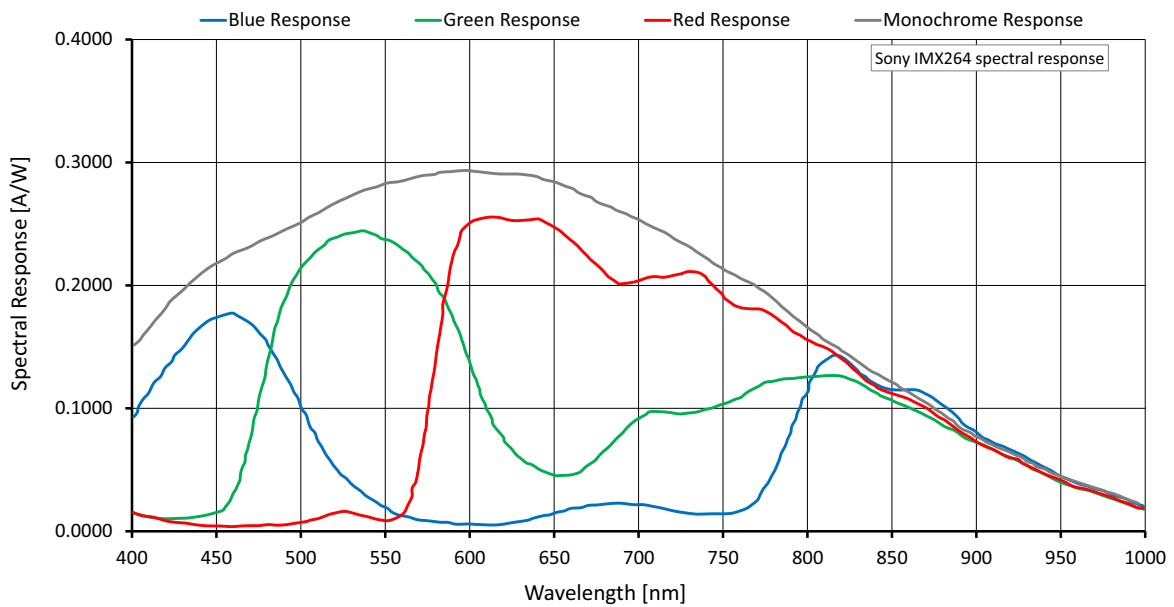

Figure 33: Alvim 1800 U-507m/c (Sony IMX264) spectral response

## ROI frame rates

Values were measured as defined in [Specified values](#) on page 67.

To reach the maximum frame rate available for this setup, the bandwidth for image traffic is 200 MByte/s. Increasing the `DeviceLinkThroughputLimit` value does not increase frame rates.

Image format	Width [pixels]	Height [pixels]	ROI area [MP]	Frame rate [fps] <sup>1</sup>		
				450 MByte/s	375 MByte/s	200 MByte/s
Full resolution	2464	2056	5.066	34.9/34.9		34.9/19.2
QXGA	2048	1536	3.146	46.4/46.4		46.4/30.6
Full HD	1920	1080	2.074	64.9/64.9		64.9/45.8
UXGA	1600	1200	1.92	58.9/58.9		58.9/49.8
WXGA+	1440	900	1.296	77.4/77.4		77.4/72.3
SXGA	1280	1024	1.311	68.6/68.6		68.6/68.6
HD 720	1280	720	0.922	95.5/95.5		
XGA	1024	768	0.786	90.1/90.1		
SVGA	800	600	0.48	113.7/113.7		
VGA	640	480	0.307	139.5/139.5		
HVGA	480	320	0.154	200.3/200.3		
QVGA	320	240	0.077	257.3/257.3		
HQVGA	240	160	0.038	356.3/356.3		
QQVGA	160	120	0.019	441.1/441.1		
Max. × half	2464	1028	2.533	67.8/67.8		67.8/37.4
Max. × min.	2464	8	0.02	1015.1/1015.1	1015.1/1015.1	1015.1/634.0
Min. × max.	8	2056	0.016	35.2/35.2		
Min. × min.	8	8	64 P	1323.2/1323.2		

<sup>1</sup> Mono8 or Bayer...8<sup>(2)</sup> at `SensorBitDepth` = 12-Bit<sup>(3)</sup> / Mono12 or Bayer...12 at `SensorBitDepth` = 12-Bit

<sup>2</sup> The three dots... represent the colors of a Bayer pixel format, such as in BayerRG8.

Table 59: Alvim 1800 U-507m/c ROI frame rates

## Alvium 1800 U-507m/c Pol (coming soon)



### Please observe

For first series models, pixel processing has not been adjusted to enable the complete functionality available with non-polarizer models:

- Only raw pixel formats are supported, but no formats for polarizer sensors.
- Features based on pixel processing are available but cannot be used to generate a proper output. For example, color processing, binning, convolution filter, DPC, or FPNC are not supported.

Feature	Specification	
	1800 U-507m Pol (monochrome)	1800 U-507c Pol (color)
Sensor model	Sony IMX264MZR	Sony IMX264MYR
Resolution	2464 (H) × 2056 (V); 5.1 MP	
Sensor type	CMOS	
Shutter type	Global shutter (GS)	
Sensor size	Type 2/3; 8.5 mm × 7.1 mm; 11.1 mm diagonal	
Pixel size	3.45 μm × 3.45 μm	
CRA	0 deg	
Sensor bit depth (ADC)	12-bit	
Monochrome pixel formats	Mono8 (default), Mono10, Mono10p, Mono12, Mono12p	Not applicable
Raw color pixel formats	Not applicable	BayerRG8, BayerRG10, BayerRG10p, BayerRG12, BayerRG12p
Maximum frame rate	34 fps (at ≥200 MByte/s)	
Exposure time	28 μs to 10 s (200 MByte/s)	
Exposure modes	Timed, TriggerControlled, TriggerWidth	
Gain	0 dB to 48 dB; 0.1 dB increments	
Multiple ROI (H × V)	<i>Free</i>	
Image buffer (RAM)	256 KByte	
Non-volatile memory (Flash)	1024 KByte	
GPIOs	4 programmable GPIOs As direct inputs (push-pull): 0 to 5.5 VDC As direct outputs (push-pull): 0 to 3.3 VDC at 12 mA	
Power requirements	Power over USB; External power	
Power consumption (typical, at 5 VDC)	USB power: 2.0 W External power: 2.2 W	

Table 60: Alvium 1800 U-507m/c Pol specifications (sheet 1 of 2)



Feature	Specification			
	<b>1800 U-507m/c</b>			
Storage temperature	-20 °C to +85 °C ambient temperature			
<b>Operating temperature</b>	<b>Hardware option</b>	<b>Housing</b>	<b>Cooling area<sup>1</sup></b>	<b>Mainboard<sup>2</sup></b>
	Bare board <sup>3</sup>	Not applicable	-20 °C to +85 °C	-20 °C to +85 °C
	Open housing <sup>4</sup>	-20 °C to +65 °C		
	Closed housing	-20 °C to +65 °C	Not applicable	
Relative humidity	0% to 80% (non-condensing)			
Digital interface	Micro-B USB 3.1 Gen 1 interface			
Camera controls	GenICam (GenICam Access)			
<sup>1</sup> See <a href="#">Mounting the heat sink</a> on page 259. <sup>2</sup> Output by DeviceTemperature <sup>3</sup> Ensure that the sensor is operated in the temperature range specified by the manufacturer. For any questions, please visit <a href="http://www.alliedvision.com/en/support">www.alliedvision.com/en/support</a> . <sup>4</sup> Temperature values must be observed for the housing <b>and</b> for the cooling area.				

Table 60: Alvium 1800 U-507m/c Pol specifications (sheet 2 of 2)

## Absolute QE, spectral response

We intend to add diagrams in a future version of this document.

## ROI frame rates

Values were measured as defined in [Specified values](#) on page 67.

To reach the maximum frame rate available for this setup, the bandwidth for image traffic is 200 MByte/s. Increasing the `DeviceLinkThroughputLimit` value does not increase frame rates.

Image format	Width [pixels]	Height [pixels]	ROI area [MP]	Frame rate [fps] <sup>1</sup>		
				450 MByte/s	375 MByte/s	200 MByte/s
Full resolution	2464	2056	5.066	34.9/34.9		34.9/19.2
QXGA	2048	1536	3.146	46.4/46.4		46.4/30.6
Full HD	1920	1080	2.074	64.9/64.9		64.9/45.8
UXGA	1600	1200	1.92	58.9/58.9		58.9/49.8
WXGA+	1440	900	1.296	77.4/77.4		77.4/72.3
SXGA	1280	1024	1.311	68.6/68.6		68.6/68.6
HD 720	1280	720	0.922	95.5/95.5		
XGA	1024	768	0.786	90.1/90.1		
SVGA	800	600	0.48	113.7/113.7		
VGA	640	480	0.307	139.5/139.5		
HVGA	480	320	0.154	200.3/200.3		
QVGA	320	240	0.077	257.3/257.3		
HQVGA	240	160	0.038	356.3/356.3		
QQVGA	160	120	0.019	441.1/441.1		
Max. × half	2464	1028	2.533	67.8/67.8		67.8/37.4
Max. × min.	2464	8	0.02	1015.1/1015.1	1015.1/1015.1	1015.1/634.0
Min. × max.	8	2056	0.016	35.2/35.2		
Min. × min.	8	8	64 P	1323.2/1323.2		

<sup>1</sup> Mono8 or Bayer...8<sup>(2)</sup> at `SensorBitDepth` = 12-Bit<sup>(3)</sup> / Mono12 or Bayer...12 at `SensorBitDepth` = 12-Bit

<sup>2</sup> The three dots... represent the colors of a Bayer pixel format, such as in BayerRG8.

Table 61: Alvium 1800 U-507m/c Pol ROI frame rates

## Alvium 1800 U-508m/c

Feature	Specification	
	1800 U-508m (monochrome)	1800 U-508c (color)
Sensor model	Sony IMX250	
Resolution	2464 (H) x 2056 (V); 5.1 MP	
Sensor type	CMOS	
Shutter type	Global shutter (GS)	
Sensor size	Type 2/3; 8.5 mm x 7.1 mm; 11.1 mm diagonal	
Pixel size	3.45 μm x 3.45 μm	
CRA	0 deg	
Sensor bit depth (ADC)	8-bit, 10-bit, 12-bit; Adaptive (10-bit, 12-bit)	
Monochrome pixel formats	Mono8 (default), Mono10, Mono10p, Mono12, Mono12p	Mono8, Mono10, Mono10p, Mono12, Mono12p
YUV color pixel formats	Not applicable	YCbCr411_8_CbYYCrYY, YCbCr422_8_CbYCrY, YCbCr8_CbYCr
RGB color pixel formats	Not applicable	BGR8, RGB8 (default)
Raw color pixel formats	Not applicable	BayerRG8, BayerRG10, BayerRG10p, BayerRG12, BayerRG12p
Maximum frame rate	84 fps (at 450 MByte/s)	
Exposure time	20 μs to 10 s (450 MByte/s)	
Exposure modes	Timed, TriggerControlled, TriggerWidth	
Gain	0 dB to 48 dB; 0.1 dB increments	
Digital binning	Horizontal: 1 to 8 columns; Vertical: 1 to 8 rows	
Sensor binning (H x V)	1 x 2 ( <i>Sum</i> )	Not applicable
Multiple ROI (H x V)	<i>Free   Tile   Horizontal</i> : 1 x 1 to 1 x 4   <i>Vertical</i> : 1 x 1 to 4 x 1	
Image buffer (RAM)	256 KByte	
Non-volatile memory (Flash)	1024 KByte	
GPIOs	4 programmable GPIOs As direct inputs (push-pull): 0 to 5.5 VDC As direct outputs (push-pull): 0 to 3.3 VDC at 12 mA	
Power requirements	Power over USB; External power	
Power consumption (typical, at 5 VDC)	USB power: 2.9 W External power: 3.1 W	

Table 62: Alvium 1800 U-508m/c specifications (sheet 1 of 2)

Feature	Specification			
	<b>1800 U-508m/c</b>			
Storage temperature	-20 °C to +85 °C ambient temperature			
<b>Operating temperature</b>	<b>Hardware option</b>	<b>Housing</b>	<b>Cooling area<sup>1</sup></b>	<b>Mainboard<sup>2</sup></b>
	Bare board <sup>3</sup>	Not applicable	-20 °C to +85 °C	-20 °C to +85 °C
	Open housing <sup>4</sup>	-20 °C to +65 °C		
	Closed housing	-20 °C to +65 °C	Not applicable	
Relative humidity	0% to 80% (non-condensing)			
Digital interface	Micro-B USB 3.1 Gen 1 interface			
Camera controls	GenICam (GenICam Access)			
<sup>1</sup> See <a href="#">Mounting the heat sink</a> on page 259. <sup>2</sup> Output by DeviceTemperature <sup>3</sup> Ensure that the sensor is operated in the temperature range specified by the manufacturer. For any questions, please visit <a href="http://www.alliedvision.com/en/support">www.alliedvision.com/en/support</a> . <sup>4</sup> Temperature values must be observed for the housing <b>and</b> for the cooling area.				

Table 62: Alvium 1800 U-508m/c specifications (sheet 2 of 2)

### Absolute QE

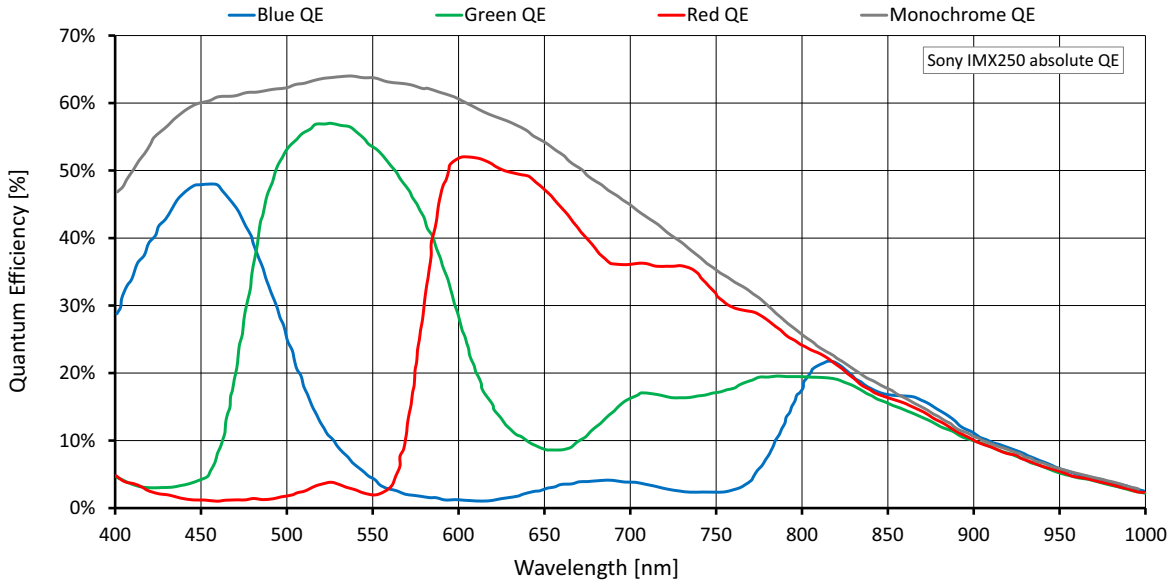

Figure 34: Alvium 1800 U-508m/c (Sony IMX250) absolute QE

### Spectral response

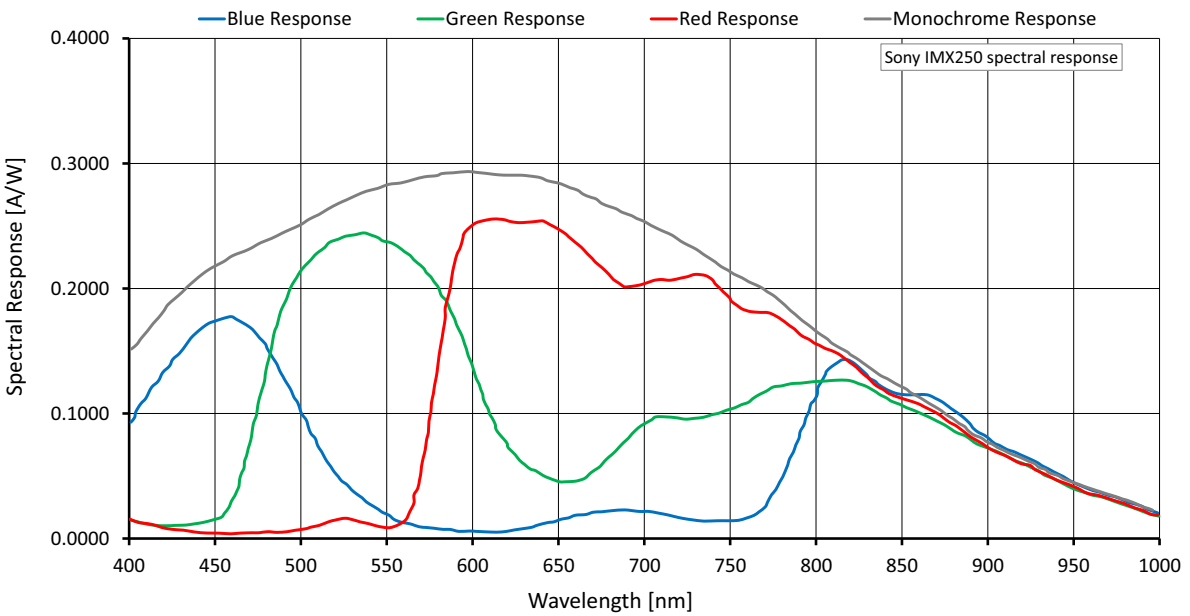

Figure 35: Alvium 1800 U-508m/c (Sony IMX250) spectral response

## ROI frame rates

Values were measured as defined in [Specified values](#) on page 67.

To reach the maximum frame rate available for this setup, the bandwidth for image traffic is 450 MByte/s.

Image format	Width [pixels]	Height [pixels]	ROI area [MP]	Frame rate [fps] <sup>1</sup>		
				450 MByte/s	375 MByte/s	200 MByte/s
Full resolution	2464	2056	5.066	84.2/42.3/42.4	71.3/35.7/35.7	38.2/19.2/19.2
QXGA	2048	1536	3.146	126.0/67.4/67.3	112.7/56.8/56.6	61.1/30.6/30.5
Full HD	1920	1080	2.074	175.8/100.8/100.0	166.8/85.2/84.7	90.6/45.8/45.6
UXGA	1600	1200	1.92	160.0/109.2/109.0	160.0/92.3/91.9	98.6/49.6/49.6
WXGA+	1440	900	1.296	209.9/159.3/146.2	209.9/134.7/134.2	143.7/72.4/72.0
SXGA	1280	1024	1.311	186.5/152.5/129.9	186.5/133.4/129.9	143.4/72.2/71.8
HD 720	1280	720	0.922	258.2/211.2/179.8	258.2/185.0/179.8	199.0/100.5/99.8
XGA	1024	768	0.786	244.9/200.1/170.6		234.6/118.3/117.7
SVGA	800	600	0.48	308.1/252.0/214.9		308.1/189.6/189.4
VGA	640	480	0.307	378.4/309.6/263.9		378.4/290.5/263.9
HVGA	480	320	0.154	541.1/443.8/377.3		
QVGA	320	240	0.077	686.8/567.5/483.8		
HQVGA	240	160	0.038	940.0/783.3/667.8		
QQVGA	160	120	0.019	1152.4/964.5/822.2		
Max. x half	2464	1028	2.533	161.9/81.9/81.9	137.4/69.2/69.1	74.2/37.4/37.3
Max. x min.	2464	8	0.02	1937.8/1139.2/ 1088.3	1748.8/1010.2/961.0	1125.8/614.7/596.7
Min. x max.	8	2056	0.016	96.5/79.1/67.4		
Min. x min.	8	8	64 P	3138.1/2735.3/2331.8		

<sup>1</sup> Mono8 or Bayer...8<sup>(2)</sup> at SensorBitDepth = 8-Bit<sup>(3)</sup> /  
 Mono10 or Bayer...10 at SensorBitDepth = 10-Bit /  
 Mono12 or Bayer...12 at SensorBitDepth = 12-Bit

<sup>2</sup> The three dots... represent the colors of a Bayer pixel format, such as in BayerRG8.

<sup>3</sup> The SensorBitDepth value must be set separately from PixelFormat.

See [Sensor ADC readout modes for maximum frame rates](#) on page 68 for details.

Table 63: Alvium 1800 U-508m/c ROI frame rates

## Alvium 1800 U-508m/c Pol (coming soon)



### Please observe

For first series models, pixel processing has not been adjusted to enable the complete functionality available with non-polarizer models:

- Only raw pixel formats are supported, but no formats for polarizer sensors.
- Features based on pixel processing are available but cannot be used to generate a proper output. For example, color processing, binning, convolution filter, DPC, or FPNC are not supported.

Feature	Specification	
	1800 U-508m Pol (monochrome)	1800 U-508c Pol (color)
Sensor model	Sony IMX250MZR	Sony IMX250MYR
Resolution	2464 (H) x 2056 (V); 5.1 MP	
Sensor type	CMOS	
Shutter type	Global shutter (GS)	
Sensor size	Type 2/3; 8.5 mm x 7.1 mm; 11.1 mm diagonal	
Pixel size	3.45 μm x 3.45 μm	
CRA	0 deg	
Sensor bit depth (ADC)	8-bit, 10-bit, 12-bit; Adaptive (10-bit, 12-bit)	
Monochrome pixel formats	Mono8 (default), Mono10, Mono10p, Mono12, Mono12p	Not applicable
Raw color pixel formats	Not applicable	BayerRG8, BayerRG10, BayerRG10p, BayerRG12, BayerRG12p
Maximum frame rate	84 fps (at 450 MByte/s)	
Exposure time	20 μs to 10 s (450 MByte/s)	
Exposure modes	Timed, TriggerControlled, TriggerWidth	
Gain	0 dB to 48 dB; 0.1 dB increments	
Multiple ROI (H x V)	<i>Free   Tile   Horizontal</i> : 1 x 1 to 1 x 4   <i>Vertical</i> : 1 x 1 to 4 x 1	
Image buffer (RAM)	256 KByte	
Non-volatile memory (Flash)	1024 KByte	
GPIOs	4 programmable GPIOs As direct inputs (push-pull): 0 to 5.5 VDC As direct outputs (push-pull): 0 to 3.3 VDC at 12 mA	
Power requirements	Power over USB; External power	
Power consumption (typical, at 5 VDC)	USB power: 2.9 W External power: 3.1 W	

Table 64: Alvium 1800 U-508m/c Pol specifications (sheet 1 of 2)

Feature	Specification			
	<b>1800 U-508m/c</b>			
Storage temperature	-20 °C to +85 °C ambient temperature			
<b>Operating temperature</b>	<b>Hardware option</b>	<b>Housing</b>	<b>Cooling area<sup>1</sup></b>	<b>Mainboard<sup>2</sup></b>
	Bare board <sup>3</sup>	Not applicable	-20 °C to +85 °C	-20 °C to +85 °C
	Open housing <sup>4</sup>	-20 °C to +65 °C		
	Closed housing	-20 °C to +65 °C	Not applicable	
Relative humidity	0% to 80% (non-condensing)			
Digital interface	Micro-B USB 3.1 Gen 1 interface			
Camera controls	GenICam (GenICam Access)			
<sup>1</sup> See <a href="#">Mounting the heat sink</a> on page 259. <sup>2</sup> Output by DeviceTemperature <sup>3</sup> Ensure that the sensor is operated in the temperature range specified by the manufacturer. For any questions, please visit <a href="http://www.alliedvision.com/en/support">www.alliedvision.com/en/support</a> . <sup>4</sup> Temperature values must be observed for the housing <b>and</b> for the cooling area.				

Table 64: Alvium 1800 U-508m/c Pol specifications (sheet 2 of 2)

## Absolute QE, spectral response

We intend to add diagrams in a future version of this document.



## ROI frame rates

Values were measured as defined in [Specified values](#) on page 67.

To reach the maximum frame rate available for this setup, the bandwidth for image traffic is 450 MByte/s.

Image format	Width [pixels]	Height [pixels]	ROI area [MP]	Frame rate [fps] <sup>1</sup>		
				450 MByte/s	375 MByte/s	200 MByte/s
Full resolution	2464	2056	5.066	84.2/42.3/42.4	71.3/35.7/35.7	38.2/19.2/19.2
QXGA	2048	1536	3.146	126.0/67.4/67.3	112.7/56.8/56.6	61.1/30.6/30.5
Full HD	1920	1080	2.074	175.8/100.8/100.0	166.8/85.2/84.7	90.6/45.8/45.6
UXGA	1600	1200	1.92	160.0/109.2/109.0	160.0/92.3/91.9	98.6/49.6/49.6
WXGA+	1440	900	1.296	209.9/159.3/146.2	209.9/134.7/134.2	143.7/72.4/72.0
SXGA	1280	1024	1.311	186.5/152.5/129.9	186.5/133.4/129.9	143.4/72.2/71.8
HD 720	1280	720	0.922	258.2/211.2/179.8	258.2/185.0/179.8	199.0/100.5/99.8
XGA	1024	768	0.786	244.9/200.1/170.6		234.6/118.3/117.7
SVGA	800	600	0.48	308.1/252.0/214.9		308.1/189.6/189.4
VGA	640	480	0.307	378.4/309.6/263.9		378.4/290.5/263.9
HVGA	480	320	0.154	541.1/443.8/377.3		
QVGA	320	240	0.077	686.8/567.5/483.8		
HQVGA	240	160	0.038	940.0/783.3/667.8		
QQVGA	160	120	0.019	1152.4/964.5/822.2		
Max. x half	2464	1028	2.533	161.9/81.9/81.9	137.4/69.2/69.1	74.2/37.4/37.3
Max. x min.	2464	8	0.02	1937.8/1139.2/ 1088.3	1748.8/1010.2/961.0	1125.8/614.7/596.7
Min. x max.	8	2056	0.016	96.5/79.1/67.4		
Min. x min.	8	8	64 P	3138.1/2735.3/2331.8		

<sup>1</sup> Mono8 or Bayer...8<sup>(2)</sup> at SensorBitDepth = 8-Bit<sup>(3)</sup> /  
 Mono10 or Bayer...10 at SensorBitDepth = 10-Bit /  
 Mono12 or Bayer...12 at SensorBitDepth = 12-Bit

<sup>2</sup> The three dots... represent the colors of a Bayer pixel format, such as in BayerRG8.

<sup>3</sup> The SensorBitDepth value must be set separately from PixelFormat.

See [Sensor ADC readout modes for maximum frame rates](#) on page 68 for details.

Table 65: Alvium 1800 U-508m/c Pol ROI frame rates

## Alvium 1800 U-510m/c

Feature	Specification	
	1800 U-510m (monochrome)	1800 U-510c (color)
Sensor model	Sony IMX548	
Resolution	2472 (H) × 2064 (V); 5.1 MP	
Sensor type	CMOS	
Shutter type	Global shutter (GS)	
Sensor size	Type 1/1.8; 6.8 mm × 5.7 mm; 8.8 mm diagonal	
Pixel size	2.74 μm × 2.74 μm	
CRA	0 deg	
Sensor bit depth (ADC)	12-bit	
Monochrome pixel formats	Mono8 (default), Mono10, Mono10p, Mono12, Mono12p	Mono8, Mono10, Mono10p, Mono12, Mono12p
YUV color pixel formats	Not applicable	YCbCr411_8_CbYYCrYY, YCbCr422_8_CbYCrY, YCbCr8_CbYCr
RGB color pixel formats	Not applicable	BGR8, RGB8 (default)
Raw color pixel formats	Not applicable	BayerRG8, BayerRG10, BayerRG10p, BayerRG12, BayerRG12p
Maximum frame rate	79 fps (at 450 MByte/s)	
Exposure time	8 μs to 10 s (450 MByte/s)	
Exposure modes	Timed	
Gain	0 dB to 48 dB; 0.1 dB increments	
Digital binning	Horizontal: 1 to 8 columns; Vertical: 1 to 8 rows	
Sensor binning (H × V)	2 × 2 ( <i>Sum</i> )	Not applicable
Multiple ROI (H × V)	<i>Free</i>   <i>Tile</i>   <i>Horizontal</i> : 1 × 1 to 1 × 4   <i>Vertical</i> : 1 × 1 to 4 × 1	
Image buffer (RAM)	256 KByte	
Non-volatile memory (Flash)	1024 KByte	
GPIOs	4 programmable GPIOs As direct inputs (push-pull): 0 to 5.5 VDC As direct outputs (push-pull): 0 to 3.3 VDC at 12 mA	
Power requirements	Power over USB; External power	
Power consumption (typical, at 5 VDC)	USB power: 3.0 W External power: 3.2 W	

Table 66: Alvium 1800 U-510m/c specifications (sheet 1 of 2)

Feature	Specification			
	<b>1800 U-510m/c</b>			
Storage temperature	-20 °C to +85 °C ambient temperature			
<b>Operating temperature</b>	<b>Hardware option</b>	<b>Housing</b>	<b>Cooling area<sup>1</sup></b>	<b>Mainboard<sup>2</sup></b>
	Bare board <sup>3</sup>	Not applicable	-20 °C to +85 °C	-20 °C to +85 °C
	Open housing <sup>4</sup>	-20 °C to +65 °C		
	Closed housing	-20 °C to +65 °C	Not applicable	
Relative humidity	0% to 80% (non-condensing)			
Digital interface	Micro-B USB 3.1 Gen 1 interface			
Camera controls	GenICam (GenICam Access)			
<sup>1</sup> See <a href="#">Mounting the heat sink</a> on page 259. <sup>2</sup> Output by DeviceTemperature <sup>3</sup> Ensure that the sensor is operated in the temperature range specified by the manufacturer. For any questions, please visit <a href="http://www.alliedvision.com/en/support">www.alliedvision.com/en/support</a> . <sup>4</sup> Temperature values must be observed for the housing <b>and</b> for the cooling area.				

Table 66: Alvium 1800 U-510m/c specifications (sheet 2 of 2)

### Absolute QE

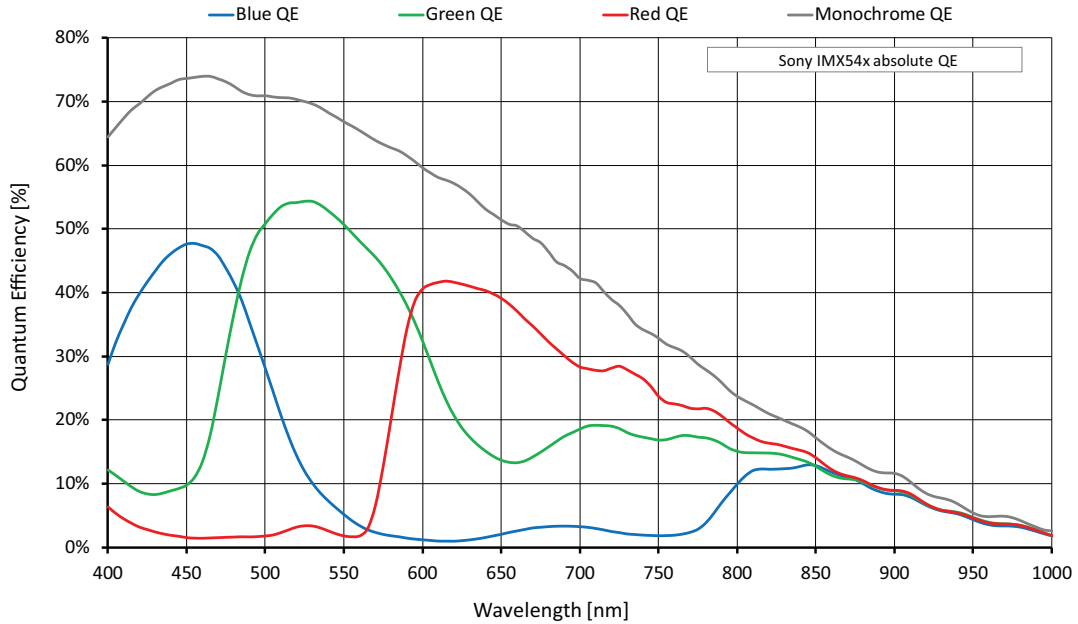

Figure 36: Alvium 1800 U-510m/c (Sony IMX548) absolute QE

### Spectral response

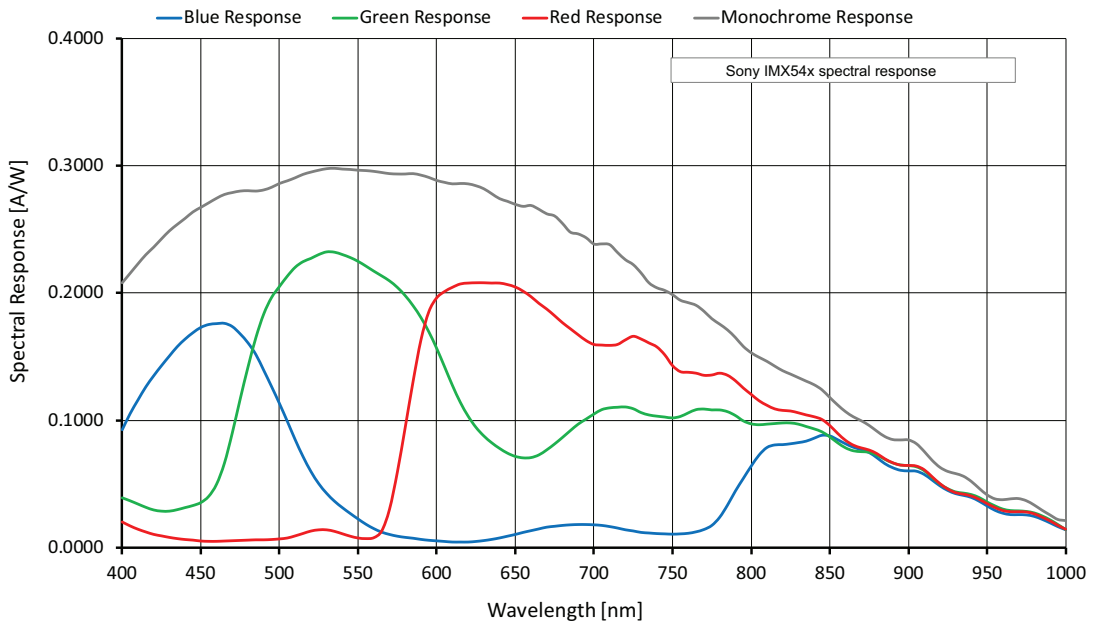

Figure 37: Alvium 1800 U-510m/c (Sony IMX548) spectral response

## ROI frame rates

Values were measured as defined in [Specified values](#) on page 67.

To reach the maximum frame rate available for this setup, the bandwidth for image traffic is 450 MByte/s.

Image format	Width [pixels]	Height [pixels]	ROI area [MP]	Frame rate [fps] <sup>1</sup>		
				450 MByte/s	375 MByte/s	200 MByte/s
Full resolution	2472	2064	5.102	79.9/40.3	67.1/33.9	36.1/18.2
QXGA	2048	1536	3.146	106.8/63.6	105.7/53.6	57.0/28.8
Full HD	1920	1080	2.074	145.5/92.7	145.5/78.2	83.0/41.9
UXGA	1600	1200	1.92	133.4/101.0	133.4/85.3	90.9/45.9
WXGA+	1440	900	1.296	170.2/143.8	170.2/121.0	129.0/65.0
SXGA	1280	1024	1.311	153.5/145.0	153.5/122.5	130.6/65.8
HD 720	1280	720	0.922	205.8/194.5	205.8/164.4	175.3/88.4
XGA	1024	768	0.786	195.9/195.9	195.9/194.2	195.9/105.1
SVGA	800	600	0.48	239.9/239.9		239.9/163.5
VGA	640	480	0.307	285.4/285.4		285.4/243.0
HVGA	480	320	0.154	380.5/380.5		380.5/340.8
QVGA	320	240	0.077	456.0/456.0		456.0/408.6
HQVGA	240	160	0.038	569.0/569.0		569.0/510.2
QQVGA	160	120	0.019	649.4/649.4		649.4/582.5
Max. × half	2472	1032	2.551	147.4/74.8	124.0/63.1	67.1/33.9
Max. × min.	2472	8	0.02	905.6/500.6	781.9/428.0	453.4/237.9
Min. × max.	8	2064	0.017	82.5/82.5		82.5/73.8
Min. × min.	8	8	64 P	1074.8/1074.8		1074.8/966.3

<sup>1</sup> Mono8 or Bayer...8<sup>(2)</sup> at SensorBitDepth = 12-Bit / Mono12 or Bayer...12 at SensorBitDepth = 12-Bit

<sup>2</sup> The three dots... represent the colors of a Bayer pixel format, such as in BayerRG8.

Table 67: Alvium 1800 U-510m/c ROI frame rates

## Alvium 1800 U-511m/c

Feature	Specification	
	1800 U-511m (monochrome)	1800 U-511c (color)
Sensor model	Sony IMX547	
Resolution	2472 (H) × 2064 (V); 5.1 MP	
Sensor type	CMOS	
Shutter type	Global shutter (GS)	
Sensor size	Type 1/1.8; 6.8 mm × 5.7 mm; 8.8 mm diagonal	
Pixel size	2.74 μm × 2.74 μm	
CRA	0 deg	
Sensor bit depth (ADC)	12-bit	
Monochrome pixel formats	Mono8 (default), Mono10, Mono10p, Mono12, Mono12p	Mono8, Mono10, Mono10p, Mono12, Mono12p
YUV color pixel formats	Not applicable	YCbCr411_8_CbYYCrYY, YCbCr422_8_CbYCrY, YCbCr8_CbYCr
RGB color pixel formats	Not applicable	BGR8, RGB8 (default)
Raw color pixel formats	Not applicable	BayerRG8, BayerRG10, BayerRG10p, BayerRG12, BayerRG12p
Maximum frame rate	79 fps (at 450 MByte/s)	
Exposure time	8 μs to 10 s (450 MByte/s)	
Exposure modes	Timed, TriggerControlled, TriggerWidth	
Gain	0 dB to 48 dB; 0.1 dB increments	
Digital binning	Horizontal: 1 to 8 columns; Vertical: 1 to 8 rows	
Sensor binning (H × V)	2 × 2 ( <i>Sum</i> )	Not applicable
Multiple ROI (H × V)	<i>Free</i>   <i>Tile</i>   <i>Horizontal</i> : 1 × 1 to 1 × 4   <i>Vertical</i> : 1 × 1 to 4 × 1	
Image buffer (RAM)	256 KByte	
Non-volatile memory (Flash)	1024 KByte	
GPIOs	4 programmable GPIOs As direct inputs (push-pull): 0 to 5.5 VDC As direct outputs (push-pull): 0 to 3.3 VDC at 12 mA	
Power requirements	Power over USB; External power	
Power consumption (typical, at 5 VDC)	USB power: 3.2 W External power: 3.4 W	

Table 68: Alvium 1800 U-511m/c specifications (sheet 1 of 2)

Feature	Specification			
	<b>1800 U-511m/c</b>			
Storage temperature	-20 °C to +85 °C ambient temperature			
<b>Operating temperature</b>	<b>Hardware option</b>	<b>Housing</b>	<b>Cooling area<sup>1</sup></b>	<b>Mainboard<sup>2</sup></b>
	Bare board <sup>3</sup>	Not applicable	-20 °C to +85 °C	-20 °C to +85 °C
	Open housing <sup>4</sup>	-20 °C to +65 °C		
	Closed housing	-20 °C to +65 °C	Not applicable	
Relative humidity	0% to 80% (non-condensing)			
Digital interface	Micro-B USB 3.1 Gen 1 interface			
Camera controls	GenICam (GenICam Access)			
<sup>1</sup> See <a href="#">Mounting the heat sink</a> on page 259. <sup>2</sup> Output by DeviceTemperature <sup>3</sup> Ensure that the sensor is operated in the temperature range specified by the manufacturer. For any questions, please visit <a href="http://www.alliedvision.com/en/support">www.alliedvision.com/en/support</a> . <sup>4</sup> Temperature values must be observed for the housing <b>and</b> for the cooling area.				

Table 68: Alvium 1800 U-511m/c specifications (sheet 2 of 2)

## Absolute QE

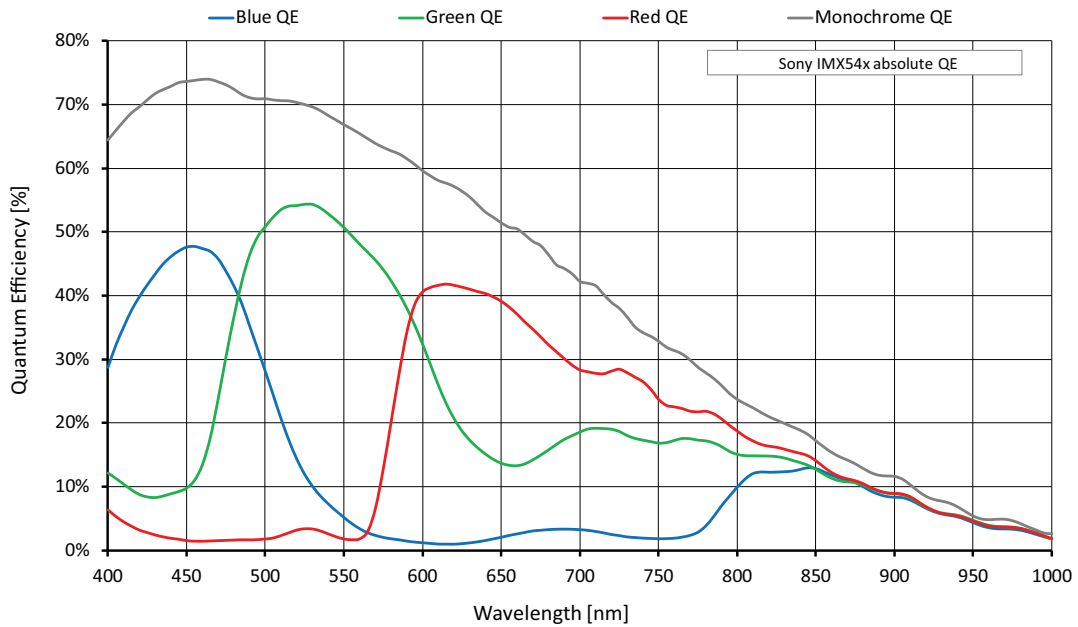

Figure 38: Alvium 1800 U-511m/c (Sony IMX547) absolute QE

## Spectral response

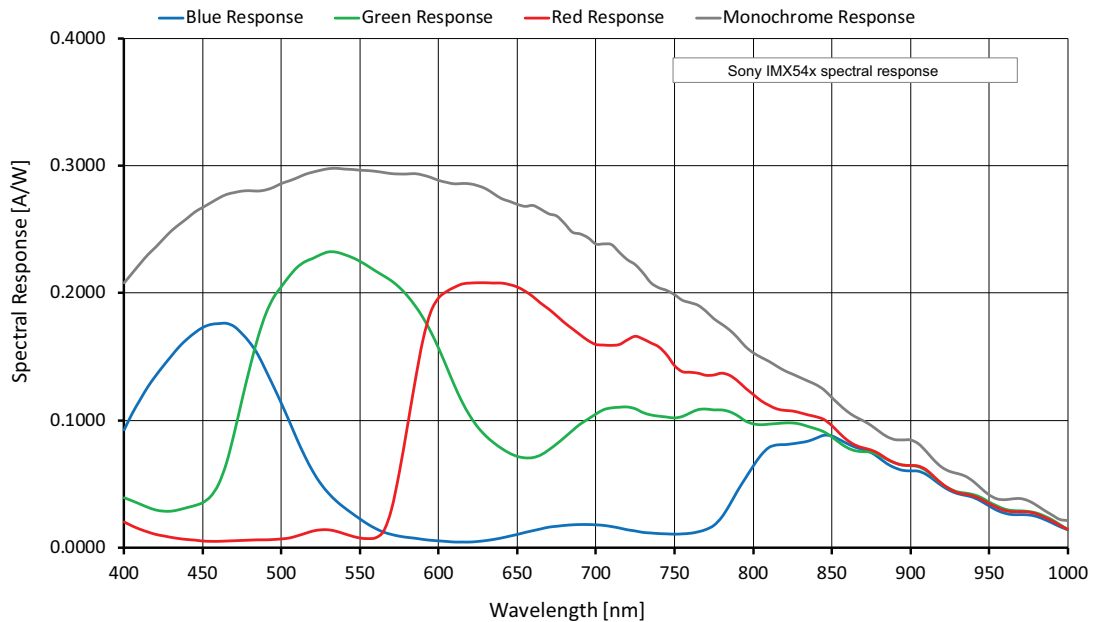

Figure 39: Alvium 1800 U-511m/c (Sony IMX547) spectral response



## ROI frame rates

Values were measured as defined in [Specified values](#) on page 67.

To reach the maximum frame rate available for this setup, the bandwidth for image traffic is 450 MByte/s.

Image format	Width [pixels]	Height [pixels]	ROI area [MP]	Frame rate [fps] <sup>1</sup>		
				450 MByte/s	375 MByte/s	200 MByte/s
Full resolution	2472	2064	5.102	79.9/40.3	67.1/33.9	36.1/18.2
QXGA	2048	1536	3.146	104.7/63.6	104.7/53.6	57.0/28.8
Full HD	1920	1080	2.074	142.7/92.7	142.7/78.2	83.0/41.9
UXGA	1600	1200	1.92	130.8/101.0	130.8/85.3	90.9/45.9
WXGA+	1440	900	1.296	167.0/143.8	167.0/121.0	129.0/65.0
SXGA	1280	1024	1.311	150.6/145.0	150.6/122.5	130.6/65.8
HD 720	1280	720	0.922	201.8/194.5	201.8/164.4	175.3/88.4
XGA	1024	768	0.786	192.3/192.3		192.3/105.0
SVGA	800	600	0.48	235.3/235.3		235.3/163.5
VGA	640	480	0.307	279.8/279.8		279.8/243.0
HVGA	480	320	0.154	373.1/373.1		373.1/340.8
QVGA	320	240	0.077	447.2/447.2		447.2/408.6
HQVGA	240	160	0.038	557.9/557.9		557.9/510.1
QQVGA	160	120	0.019	636.8/636.8		636.8/582.5
Max. × half	2472	1032	2.551	147.4/74.8	124.0/63.1	67.1/33.9
Max. × min.	2472	8	0.02	905.6/500.6	781.9/428.0	453.4/237.9
Min. × max.	8	2064	0.017	80.9/80.9	80.9/80.9	80.9/73.8
Min. × min.	8	8	64 P	1053.9/1053.9	1053.9/1053.9	1053.9/966.3

<sup>1</sup> Mono8 or Bayer...8<sup>(2)</sup> at SensorBitDepth = 12-Bit / Mono12 or Bayer...12 at SensorBitDepth = 12-Bit

<sup>2</sup> The three dots... represent the colors of a Bayer pixel format, such as in BayerRG8.

Table 69: Alvium 1800 U-511m/c ROI frame rates

## Alvium 1800 U-530 VSWIR (coming soon)

Feature	Specification
	<b>1800 U-530 VSWIR</b>
Sensor model	Sony IMX992
Resolution	2592(H) × 2056(V); 5.3 MP
Sensor type	InGaAs
Shutter type	Global shutter (GS)
Sensor size	Type 1/1.4; 8.9 mm × 7.1 mm; 11.4 mm diagonal
Pixel size	3.45 μm × 3.45 μm
CRA	Tbd
Sensor bit depth (ADC)	8-bit, 10-bit, 12-bit; Adaptive (10-bit, 12-bit)
Monochrome pixel formats	Mono8 (default), Mono10, Mono10p, Mono12, Mono12p
Maximum frame rate	77 fps (at 450 MByte/s)
Exposure time	27 μs to 10 s (450 MByte/s)
Exposure modes	Timed, TriggerControlled, TriggerWidth
Gain	0 dB to 42 dB; 0.1 dB increments
Digital binning	Horizontal: 1 to 8 columns; Vertical: 1 to 8 rows
Multiple ROI (H × V)	<i>Free   Tile   Horizontal</i> : 1 × 1 to 1 × 4   <i>Vertical</i> : 1 × 1 to 4 × 1
Image buffer (RAM)	256 KByte
Non-volatile memory (Flash)	1024 KByte
GPIOs	4 programmable GPIOs As direct inputs (push-pull): 0 to 5.5 VDC As direct outputs (push-pull): 0 to 3.3 VDC at 12 mA
Power requirements	Power over USB; External power
Power consumption (typical, at 5 VDC)	Tbd

Table 70: Alvium 1800 U-530 VSWIR specifications (sheet 1 of 2)

Feature	Specification			
	<b>1800 U-530 VSWIR</b>			
Storage temperature	-20 °C to +85 °C ambient temperature			
<b>Operating temperature</b>	<b>Hardware option</b>	<b>Housing</b>	<b>Cooling area<sup>1</sup></b>	<b>Mainboard<sup>2</sup></b>
	Bare board <sup>3</sup>	Not applicable	-20 °C to +85 °C	-20 °C to +85 °C
	Open housing <sup>4</sup>	-20 °C to +65 °C		
	Closed housing	-20 °C to +65 °C	Not applicable	
Relative humidity	0% to 80% (non-condensing)			
Digital interface	Micro-B USB 3.1 Gen 1 interface			
Camera controls	GenICam (GenICam Access)			
<sup>1</sup> See <a href="#">Mounting the heat sink</a> on page 259. <sup>2</sup> Output by DeviceTemperature <sup>3</sup> Ensure that the sensor is operated in the temperature range specified by the manufacturer. For any questions, please visit <a href="http://www.alliedvision.com/en/support">www.alliedvision.com/en/support</a> . <sup>4</sup> Temperature values must be observed for the housing <b>and</b> for the cooling area.				

Table 70: Alvium 1800 U-530 VSWIR specifications (sheet 2 of 2)

## Absolute QE, spectral response

We intend to add diagrams in a future version of this document.

## ROI frame rates

Values were measured as defined in [Specified values](#) on page 67.

To reach the maximum frame rate available for this setup, the bandwidth for image traffic is 450 MByte/s.

Image format	Width [pixels]	Height [pixels]	ROI area [MP]	Frame rate [fps] <sup>1</sup>		
				450 MByte/s	375 MByte/s	200 MByte/s
Full resolution	2592	2056	5.329	77.7 / 38.9 / 38.9	64.6 / 32.5 / 32.4	34.8 / 17.5 / 17.5
QXGA	2560	2048	5.243	78.7 / 39.7 / 39.6	65.9 / 33.1 / 33.1	35.4 / 17.7 / 17.7
WQHD	2560	1440	3.686	108.3 / 54.8 / 54.6	90.7 / 45.8 / 45.7	48.9 / 24.5 / 24.5
QXGA	2048	1536	3.146	110.9 / 64.3 / 64.3	106.6 / 53.8 / 53.6	57.4 / 28.9 / 28.9
Full HD	1920	1080	2.074	151.5 / 94.1 / 93.5	151.5 / 78.3 / 78.4	83.9 / 42.2 / 42.2
UXGA	1600	1200	1.920	138.8 / 102.8 / 96.4	138.8 / 86.0 / 85.7	91.9 / 46.2 / 46.2
WXGA+	1440	900	1.296	177.7 / 145.0 / 123.4	177.7 / 121.5 / 120.8	130.7 / 65.8 / 65.5
SXGA	1280	1024	1.311	160.0 / 130.7 / 111.1	160.0 / 123.1 / 111.1	132.2 / 66.2 / 66.2
HD 720	1280	720	0.922	215.2 / 175.8 / 149.4	215.2 / 165.6 / 149.4	178.1 / 89.4 / 89.2
XGA	1024	768	0.786	205.0 / 167.4 / 142.3		205.0 / 105.7 / 105.9
SVGA	800	600	0.480	251.9 / 205.4 / 174.8		251.9 / 166.4 / 166.2
VGA	640	480	0.307	300.7 / 245.5 / 209.0		
HVGA	480	320	0.154	405.6 / 330.5 / 281.3		
QVGA	320	240	0.077	492.0 / 401.8 / 341.9		
HQVGA	240	160	0.038	623.1 / 508.8 / 433.1		
QQVGA	160	120	0.019	723.0 / 590.4 / 500.6		
Max. × half	2592	1028	2.665	143.5 / 72.2 / 72.1	119.6 / 60.5 / 60.2	64.8 / 32.6 / 32.6
Max. × min.	2592	8	0.021	937.7 / 504.9 / 491.7	803.9 / 431.7 / 420.8	469.6 / 244.1 / 240.9
Min. × max.	8	2056	0.016	86.2 / 70.4 / 60.0		
Min. × min.	8	8	0.000	1279.8 / 1045.2 / 889.5		

<sup>1</sup> Mono8 at **SensorBitDepth** = 8-Bit<sup>(2)</sup> / Mono10 at **SensorBitDepth** = 10-Bit / Mono12 or at **SensorBitDepth** = 12-Bit

<sup>2</sup> The **SensorBitDepth** value must be set separately from **PixelFormat**.  
See [Sensor ADC readout modes for maximum frame rates](#) on page 68 for details.

Table 71: Alvium 1800 U-530 VSWIR ROI frame rates (calculated values)

## Alvium 1800 U-811m/c

Feature	Specification	
	1800 U-811m (monochrome)	1800 U-811c (color)
Sensor model	Sony IMX546	
Resolution	2848 (H) × 2848 (V); 8.1 MP	
Sensor type	CMOS	
Shutter type	Global shutter (GS)	
Sensor size	Type 2/3; 7.8 mm × 7.8 mm; 11 mm diagonal	
Pixel size	2.74 μm × 2.74 μm	
CRA	0 deg	
Sensor bit depth (ADC)	12-bit	
Monochrome pixel formats	Mono8 (default), Mono10, Mono10p, Mono12, Mono12p	Mono8, Mono10, Mono10p, Mono12, Mono12p
YUV color pixel formats	Not applicable	YCbCr411_8_CbYYCrYY, YCbCr422_8_CbYCrY, YCbCr8_CbYCr
RGB color pixel formats	Not applicable	BGR8, RGB8 (default)
Raw color pixel formats	Not applicable	BayerRG8, BayerRG10, BayerRG10p, BayerRG12, BayerRG12p
Maximum frame rate	51 fps (at 450 MByte/s)	
Exposure time	9 μs to 10 s (450 MByte/s)	
Exposure modes	Timed, TriggerControlled, TriggerWidth	
Gain	0 dB to 48 dB; 0.1 dB increments	
Digital binning	Horizontal: 1 to 8 columns; Vertical: 1 to 8 rows	
Sensor binning (H × V)	2 × 2 ( <i>Sum</i> )	Not applicable
Multiple ROI (H × V)	<i>Free   Tile   Horizontal</i> : 1 × 1 to 1 × 4   <i>Vertical</i> : 1 × 1 to 4 × 1	
Image buffer (RAM)	256 KByte	
Non-volatile memory (Flash)	1024 KByte	
GPIOs	4 programmable GPIOs As direct inputs (push-pull): 0 to 5.5 VDC As direct outputs (push-pull): 0 to 3.3 VDC at 12 mA	
Power requirements	Power over USB; External power	
Power consumption (typical, at 5 VDC)	USB power: 3.3 W External power: 3.5 W	

Table 72: Alvium 1800 U-811m/c specifications (sheet 1 of 2)

Feature	Specification			
	<b>1800 U-811m/c</b>			
Storage temperature	-20 °C to +85 °C ambient temperature			
<b>Operating temperature</b>	<b>Hardware option</b>	<b>Housing</b>	<b>Cooling area<sup>1</sup></b>	<b>Mainboard<sup>2</sup></b>
	Bare board <sup>3</sup>	Not applicable	-20 °C to +85 °C	-20 °C to +85 °C
	Open housing <sup>4</sup>	-20 °C to +65 °C		
	Closed housing	-20 °C to +65 °C	Not applicable	
Relative humidity	0% to 80% (non-condensing)			
Digital interface	Micro-B USB 3.1 Gen 1 interface			
Camera controls	GenICam (GenICam Access)			
<sup>1</sup> See <a href="#">Mounting the heat sink</a> on page 259. <sup>2</sup> Output by DeviceTemperature <sup>3</sup> Ensure that the sensor is operated in the temperature range specified by the manufacturer. For any questions, please visit <a href="http://www.alliedvision.com/en/support">www.alliedvision.com/en/support</a> . <sup>4</sup> Temperature values must be observed for the housing <b>and</b> for the cooling area.				

Table 72: Alvium 1800 U-811m/c specifications (sheet 2 of 2)

### Absolute QE

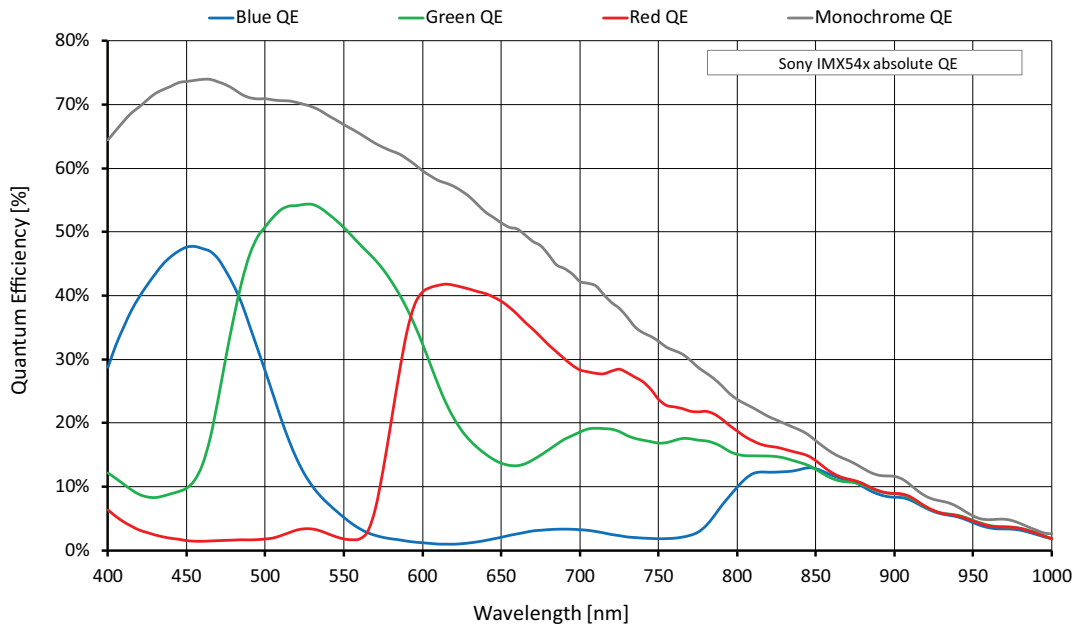

Figure 40: Alvium 1800 U-811m/c (Sony IMX546) absolute QE

### Spectral response

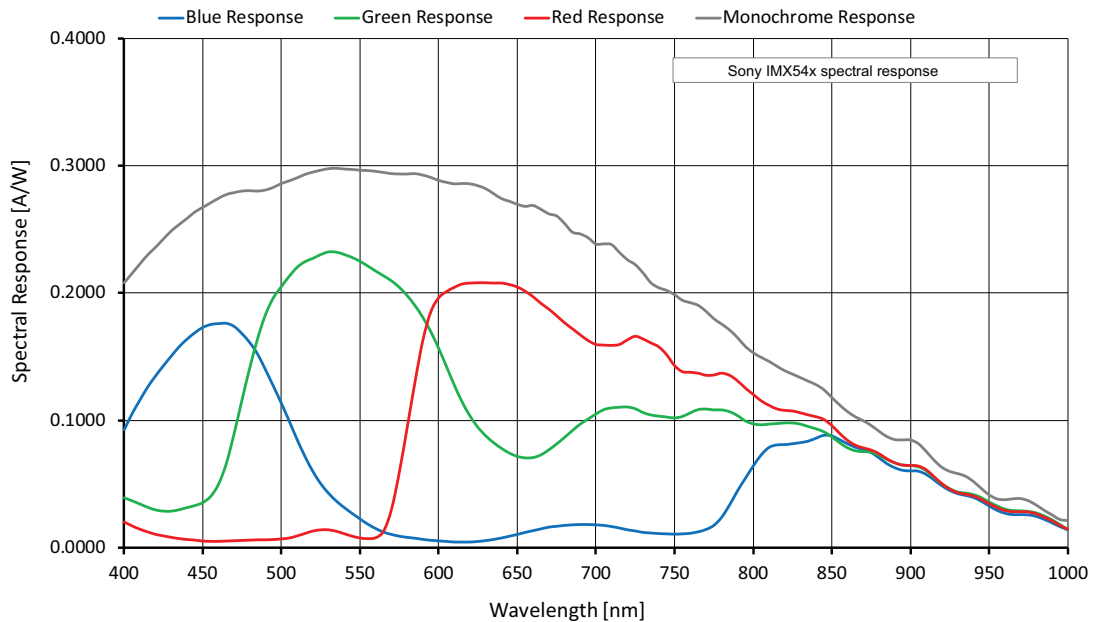

Figure 41: Alvium 1800 U-811m/c (Sony IMX546) spectral response

## ROI frame rates

Values were measured as defined in [Specified values](#) on page 67.

To reach the maximum frame rate available for this setup, the bandwidth for image traffic is 450 MByte/s.

Image format	Width [pixels]	Height [pixels]	ROI area [MP]	Frame rate [fps] <sup>1</sup>		
				450 MByte/s	375 MByte/s	200 MByte/s
Full resolution	2848	2848	8.111	51.3/25.8	43.4/21.8	23.2/11.7
QSXGA	2560	2048	5.243	77.5/39.1	65.5/33.0	35.2/17.7
WQHD	2560	1440	3.686	106.4/53.8	89.9/45.4	48.4/24.4
QXGA	2048	1536	3.146	104.7/63.6	104.7/53.6	57.0/28.8
Full HD	1920	1080	2.074	142.7/92.7	142.7/78.2	83.0/41.9
UXGA	1600	1200	1.92	130.8/101.0	130.8/85.3	90.9/45.9
WXGA+	1440	900	1.296	167.0/143.8	167.0/121.0	129.0/65.0
SXGA	1280	1024	1.311	150.6/145.0	150.6/122.5	130.6/65.8
HD 720	1280	720	0.922	201.8/194.5	201.8/164.4	175.3/88.4
XGA	1024	768	0.786	192.3/192.3		192.3/105.1
SVGA	800	600	0.48	235.3/235.3		235.3/163.5
VGA	640	480	0.307	279.8/279.8		279.8/243.0
HVGA	480	320	0.154	373.1/373.1		373.1/340.8
QVGA	320	240	0.077	447.2/447.2		447.2/408.6
HQVGA	240	160	0.038	558.0/557.9		557.9/510.2
QQVGA	160	120	0.019	636.8/636.8		636.8/582.5
Max. × half	2848	1424	4.056	96.6/48.9	81.8/41.3	43.9/22.1
Max. × min.	2848	8	0.023	783.9/433.3	682.1/371.9	393.5/206.4
Min. × max.	8	2848	0.023	59.9/59.9		59.9/54.6
Min. × min.	8	8	64 P	1053.9/1053.9		1053.9/966.3

<sup>1</sup> Mono8 or Bayer...8<sup>(2)</sup> at SensorBitDepth = 12-Bit / Mono12 or Bayer...12 at SensorBitDepth = 12-Bit

<sup>2</sup> The three dots... represent the colors of a Bayer pixel format, such as in BayerRG8.

Table 73: Alvium 1800 U-811m/c ROI frame rates



## Alvium 1800 U-812 UV



### NOTICE

#### Sensor aging by UV radiation

The sensor in this camera model is dedicated for imaging in the UV spectrum. However, UV radiation causes aging, which is permanently increasing the dark current and decreasing the QE (quantum efficiency).

To reduce sensor aging, we recommend you to:

- Minimize the intensity of UV radiation.
- Avoid wavelengths below 250 nm. For example, consider the use of bandpass filters to block shorter wavelengths.

Feature	Specification	
	1800 U-812 (monochrome)	
Sensor model	Sony IMX487	
Resolution	2848 (H) × 2848 (V); 8.1 MP	
Sensor type	CMOS	
Shutter type	Global shutter (GS)	
Sensor size	Type 2/3; 7.8 mm × 7.8 mm; 11 mm diagonal	
Pixel size	2.74 μm × 2.74 μm	
CRA	0 deg	
Sensor bit depth (ADC)	12-bit	
Monochrome pixel formats	Mono8 (default), Mono10, Mono10p, Mono12, Mono12p	
Maximum frame rate	51 fps (at 450 MByte/s)	
Exposure time	9 μs to 10 s (450 MByte/s)	
Exposure modes	Timed, TriggerControlled, TriggerWidth	
Gain	0 dB to 48 dB; 0.1 dB increments	
Digital binning	Horizontal: 1 to 8 columns; Vertical: 1 to 8 rows	
Sensor binning (H × V)	2 × 2 ( <i>Sum</i> )	Not applicable
Multiple ROI (H × V)	<i>Free   Tile   Horizontal</i> : 1 × 1 to 1 × 4   <i>Vertical</i> : 1 × 1 to 4 × 1	
Image buffer (RAM)	256 KByte	
Non-volatile memory (Flash)	1024 KByte	
GPIOs	4 programmable GPIOs	
	As direct inputs (push-pull): 0 to 5.5 VDC As direct outputs (push-pull): 0 to 3.3 VDC at 12 mA	
Power requirements	Power over USB; External power	
Power consumption (typical, at 5 VDC)	USB power: 3.9 W	
	External power: 4.1 W	

Table 74: Alvium 1800 U-812 UV specifications (sheet 1 of 2)

Feature	Specification			
	<b>1800 U-812 UV</b>			
Storage temperature	-20 °C to +85 °C ambient temperature			
<b>Operating temperature</b>	<b>Hardware option</b>	<b>Housing</b>	<b>Cooling area<sup>1</sup></b>	<b>Mainboard<sup>2</sup></b>
	Bare board <sup>3</sup>	Not applicable	-20 °C to +85 °C	-20 °C to +85 °C
	Open housing <sup>4</sup>	-20 °C to +65 °C		
	Closed housing	-20 °C to +65 °C	Not applicable	
Relative humidity	0% to 80% (non-condensing)			
Digital interface	Micro-B USB 3.1 Gen 1 interface			
Camera controls	GenICam (GenICam Access)			
<sup>1</sup> See <a href="#">Mounting the heat sink</a> on page 259. <sup>2</sup> Output by <code>DeviceTemperature</code> <sup>3</sup> Ensure that the sensor is operated in the temperature range specified by the manufacturer. For any questions, please visit <a href="http://www.alliedvision.com/en/support">www.alliedvision.com/en/support</a> . <sup>4</sup> Temperature values must be observed for the housing <b>and</b> for the cooling area.				

*Table 74: Alvium 1800 U-812 UV specifications (sheet 2 of 2)*

### Absolute QE

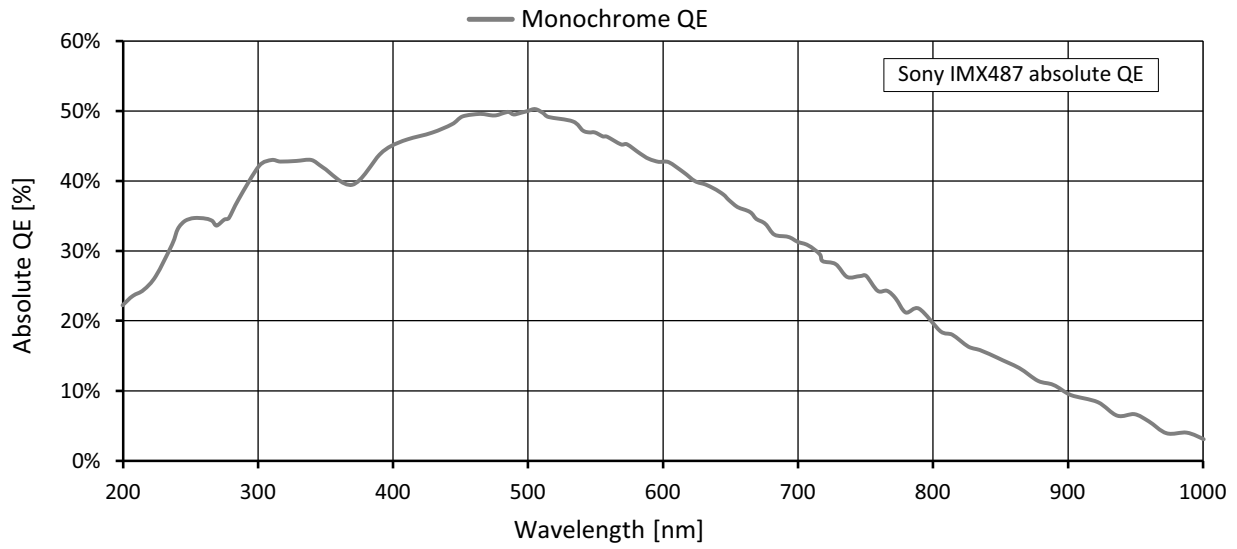

Figure 42: Alvium 1800 U-812 UV (Sony IMX487) absolute QE

### Spectral response

We intend to add a diagram in a future version of this document.

## ROI frame rates

Values were measured as defined in [Specified values](#) on page 67.

To reach the maximum frame rate available for this setup, the bandwidth for image traffic is 450 MByte/s.

Image format	Width [pixels]	Height [pixels]	ROI area [MP]	Frame rate [fps] <sup>1</sup>		
				450 MByte/s	375 MByte/s	200 MByte/s
Full resolution	2848	2848	8.111	51.0/25.7	43.1/21.7	23.1/11.6
QSXGA	2560	2048	5.243	76.8/38.7	64.9/32.7	34.8/17.5
WQHD	2560	1440	3.686	105.1/53.1	88.9/44.9	47.8/24.1
QXGA	2048	1536	3.146	103.5/62.8	103.5/53.0	56.3/28.4
Full HD	1920	1080	2.074	139.6/90.6	139.6/76.5	81.1/40.9
UXGA	1600	1200	1.92	128.9/99.5	128.9/84.0	89.6/45.2
WXGA+	1440	900	1.296	162.8/140.1	162.8/117.9	125.7/63.3
SXGA	1280	1024	1.311	148.1/142.7	148.1/120.5	128.5/64.7
HD 720	1280	720	0.922	197.4/190.2	197.4/160.8	171.4/86.5
XGA	1024	768	0.786	188.3/188.3		188.3/102.8
SVGA	800	600	0.48	227.0/227.0		227.0/157.7
VGA	640	480	0.307	271.4/271.4		271.4/235.6
HVGA	480	320	0.154	358.3/358.3		358.3/327.2
QVGA	320	240	0.077	426.0/426.0		426.0/389.3
HQVGA	240	160	0.038	525.4/525.4		525.4/480.3
QQVGA	160	120	0.019	579.5/579.5		579.5/529.9
Max. × half	2848	1424	4.056	95.4/48.3	80.8/40.8	43.4/21.8
Max. × min.	2848	8	0.023	687.2/375.0	595.7/321.1	340.0/177.2
Min. × max.	8	2848	0.023	59.5/59.5		59.5/54.2
Min. × min.	8	8	64 P	905.6/905.6		905.6/829.6

<sup>1</sup> Mono8 or Bayer...8<sup>(2)</sup> at **SensorBitDepth** = 12-Bit /  
Mono12 or Bayer...12 at **SensorBitDepth** = 12-Bit

<sup>2</sup> The three dots... represent the colors of a Bayer pixel format, such as in Bayer**RG8**.

Table 75: Alvium 1800 U-812 UV ROI frame rates

## Alvium 1800 U-895m/c

Feature	Specification	
	1800 U-895m (monochrome)	1800 U-895c (color)
Sensor model	Sony IMX267	
Resolution	4112 (H) × 2176 (V); 8.95 MP	
Sensor type	CMOS	
Shutter type	Global shutter (GS)	
Sensor size	Type 1; 14.2 mm × 7.5 mm; 16.0 mm diagonal	
Pixel size	3.45 μm × 3.45 μm	
CRA	0 deg	
Sensor bit depth (ADC)	12-bit	
Monochrome pixel formats	Mono8 (default), Mono10, Mono10p, Mono12, Mono12p	Mono8, Mono10, Mono10p, Mono12, Mono12p
YUV color pixel formats	Not applicable	YCbCr411_8_CbYYCrYY, YCbCr422_8_CbYCrY, YCbCr8_CbYCr
RGB color pixel formats	Not applicable	BGR8, RGB8 (default)
Raw color pixel formats	Not applicable	BayerRG8, BayerRG10, BayerRG10p, BayerRG12, BayerRG12p
Maximum frame rate	31 fps (at ≥375 MByte/s)	
Exposure time	29 μs to 10 s (375 MByte/s)	
Exposure modes	Timed, TriggerControlled, TriggerWidth	
Gain	0 dB to 48 dB; 0.1 dB increments	
Digital binning <sup>1</sup>	Horizontal: 1 to 8 columns; Vertical: 1 to 8 rows	
Multiple ROI (H × V)	<i>Free</i>	
Image buffer (RAM)	256 KByte	
Non-volatile memory (Flash)	1024 KByte	
GPIOs	4 programmable GPIOs As direct inputs (push-pull): 0 to 5.5 VDC As direct outputs (push-pull): 0 to 3.3 VDC at 12 mA	
Power requirements	Power over USB; External power	
Power consumption (typical, at 5 VDC)	USB power: 2.8 W External power: 2.8 W	

<sup>1</sup> Digital vertical binning can be used only when digital horizontal binning is used as well.

Table 76: Alvium 1800 U-895m/c specifications (sheet 1 of 2)

Feature	Specification			
	<b>1800 U-895m/c</b>			
Storage temperature	-20 °C to +85 °C ambient temperature			
<b>Operating temperature</b>	<b>Hardware option</b>	<b>Housing</b>	<b>Cooling area<sup>1</sup></b>	<b>Mainboard<sup>2</sup></b>
	Bare board <sup>3</sup>	Not applicable	-20 °C to +85 °C	-20 °C to +85 °C
	Open housing <sup>4</sup>	-20 °C to +65 °C		
	Closed housing	-20 °C to +65 °C	Not applicable	
Relative humidity	0% to 80% (non-condensing)			
Digital interface	Micro-B USB 3.1 Gen 1 interface			
Camera controls	GenICam (GenICam Access)			
<sup>1</sup> See <a href="#">Mounting the heat sink</a> on page 259. <sup>2</sup> Output by DeviceTemperature <sup>3</sup> Ensure that the sensor is operated in the temperature range specified by the manufacturer. For any questions, please visit <a href="http://www.alliedvision.com/en/support">www.alliedvision.com/en/support</a> . <sup>4</sup> Temperature values must be observed for the housing <b>and</b> for the cooling area.				

Table 76: Alvium 1800 U-895m/c specifications (sheet 2 of 2)

## Absolute QE

We intend to add diagrams in a future version of this document.

## Spectral response

We intend to add diagrams in a future version of this document.

## ROI frame rates

Values were measured as defined in [Specified values](#) on page 67.

To reach the maximum frame rate available for this setup, the bandwidth for image traffic is 375 MByte/s. Increasing the `DeviceLinkThroughputLimit` value does not increase frame rates.

Image format	Width [pixels]	Height [pixels]	ROI area [MP]	Frame rate [fps] <sup>1</sup>		
				450 MByte/s	375 MByte/s	200 MByte/s
Full resolution	4112	2176	8.948	31.5/24.0	31.5/20.3	21.6/10.9
UHD 4K	3840	2160	8.294	31.8/25.9	31.8/21.9	23.3/11.8
QSXGA	2560	2048	5.243	33.6/33.6		33.6/18.6
WQHD	2560	1440	3.686	47.2/47.2		47.2/26.1
QXGA	2048	1536	3.146	44.5/44.5		44.5/30.6
Full HD	1920	1080	2.074	62.3/62.3		62.3/45.8
UXGA	1600	1200	1.92	56.5/56.5		56.5/49.8
WXGA+	1440	900	1.296	74.4/74.4		74.4/72.3
SXGA	1280	1024	1.311	65.9/65.9		
HD 720	1280	720	0.922	91.8/91.8		
XGA	1024	768	0.786	86.6/86.6		
SVGA	800	600	0.48	109.2/109.2		
VGA	640	480	0.307	134.4/134.4		
HVGA	480	320	0.154	193.3/193.3		
QVGA	320	240	0.077	247.8/247.8		
HQVGA	240	160	0.038	345.2/345.2		
QQVGA	160	120	0.019	428.4/428.4		
Max. × half	4112	1088	4.474	60.9/46.6	60.9/39.4	42.0/21.3
Max. × min.	4112	8	0.033	808.2/684.0	808.2/606.6	638.5/379.9
Min. × max.	8	2176	0.017	32.0/32.0		
Min. × min.	8	8	64 P	1317.0/1317.0		

<sup>1</sup> Mono8 or Bayer...8<sup>(2)</sup> at `SensorBitDepth` = 12-Bit / Mono12 or Bayer...12 at `SensorBitDepth` = 12-Bit

<sup>2</sup> The three dots... represent the colors of a Bayer pixel format, such as in BayerRG8.

Table 77: Alvium 1800 U-895m/c ROI frame rates

## Alvium 1800 U-1236m/c

Feature	Specification	
	1800 U-1236m (monochrome)	1800 U-1236c (color)
Sensor model	Sony IMX304	
Resolution	4112 (H) × 3008 (V); 12.4 MP	
Sensor type	CMOS	
Shutter type	Global shutter (GS)	
Sensor size	Type 1.1; 14.2 mm × 10.4 mm; 17.6 mm diagonal	
Pixel size	3.45 μm × 3.45 μm	
CRA	0 deg	
Sensor bit depth (ADC)	12-bit	
Monochrome pixel formats	Mono8 (default), Mono10, Mono10p, Mono12, Mono12p	Mono8, Mono10, Mono10p, Mono12, Mono12p
YUV color pixel formats	Not applicable	YCbCr411_8_CbYYCrYY, YCbCr422_8_CbYCrY, YCbCr8_CbYCr
RGB color pixel formats	Not applicable	BGR8, RGB8 (default)
Raw color pixel formats	Not applicable	BayerRG8, BayerRG10, BayerRG10p, BayerRG12, BayerRG12p
Maximum frame rate	23 fps (at ≥300 MByte/s)	
Exposure time	29 μs to 10 s (300 MByte/s)	
Exposure modes	Timed, TriggerControlled, TriggerWidth	
Gain	0 dB to 48 dB; 0.1 dB increments	
Digital binning <sup>1</sup>	Horizontal: 1 to 8 columns; Vertical: 1 to 8 rows	
Multiple ROI (H × V)	<i>Free</i>	
Image buffer (RAM)	256 KByte	
Non-volatile memory (Flash)	1024 KByte	
GPIOs	4 programmable GPIOs As direct inputs (push-pull): 0 to 5.5 VDC As direct outputs (push-pull): 0 to 3.3 VDC at 12 mA	
Power requirements	Power over USB; External power	
Power consumption (typical, at 5 VDC)	USB power: 2.9 W External power: 3.1 W	

<sup>1</sup> Digital vertical binning can be used only when digital horizontal binning is used as well.

Table 78: Alvium 1800 U-1236m/c specifications (sheet 1 of 2)



Feature	Specification			
	<b>1800 U-1236m/c</b>			
Storage temperature	-20 °C to +85 °C ambient temperature			
<b>Operating temperature</b>	<b>Hardware option</b>	<b>Housing</b>	<b>Cooling area<sup>1</sup></b>	<b>Mainboard<sup>2</sup></b>
	Bare board <sup>3</sup>	Not applicable	-20 °C to +85 °C	-20 °C to +88 °C
	Open housing <sup>4</sup>	-20 °C to +65 °C		
	Closed housing	-20 °C to +65 °C	Not applicable	
Relative humidity	0% to 80% (non-condensing)			
Digital interface	Micro-B USB 3.1 Gen 1 interface			
Camera controls	GenICam (GenICam Access)			
<sup>1</sup> See <a href="#">Mounting the heat sink</a> on page 259. <sup>2</sup> Output by DeviceTemperature <sup>3</sup> Ensure that the sensor is operated in the temperature range specified by the manufacturer. For any questions, please visit <a href="http://www.alliedvision.com/en/support">www.alliedvision.com/en/support</a> . <sup>4</sup> Temperature values must be observed for the housing <b>and</b> for the cooling area.				

Table 78: Alvium 1800 U-1236m/c specifications (sheet 2 of 2)

### Absolute QE

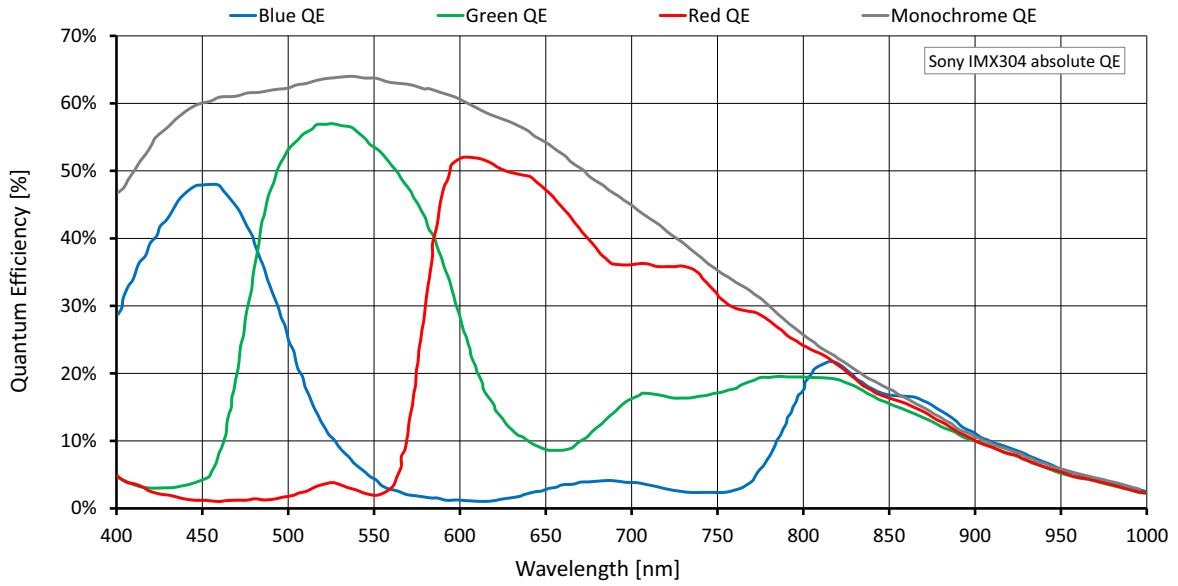

Figure 43: Alvim 1800 U-1236m/c (Sony IMX304) absolute QE

### Spectral response

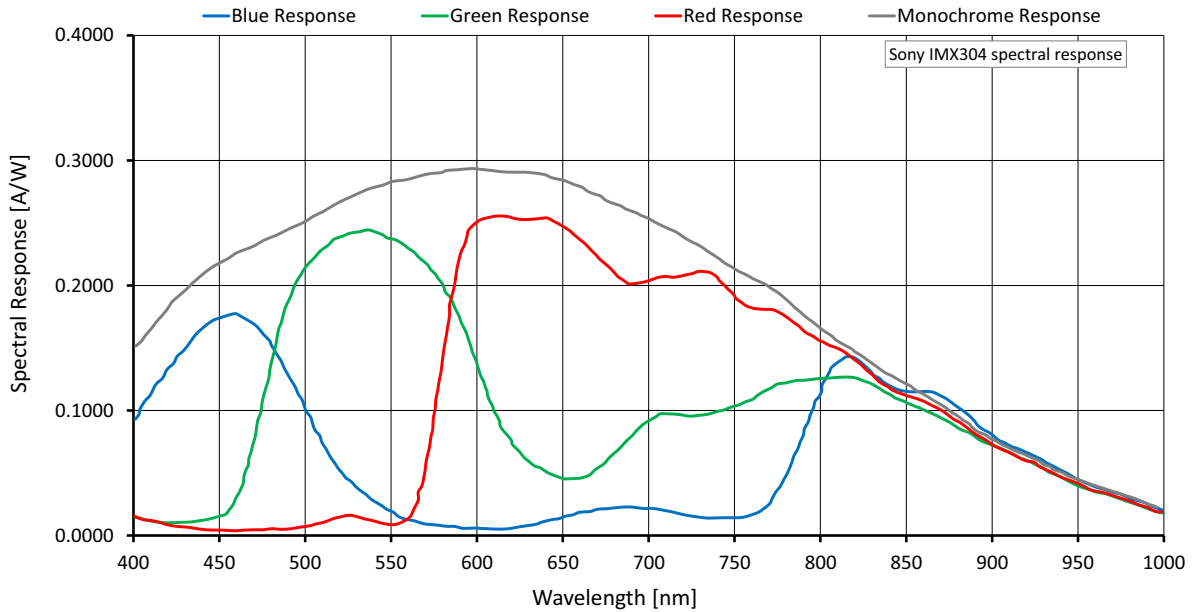

Figure 44: Alvim 1800 U-1236m/c (Sony IMX304) spectral response

## ROI frame rates

Values were measured as defined in [Specified values](#) on page 67.

To reach the maximum frame rate available for this setup, the bandwidth for image traffic is 300 MByte/s. Increasing the `DeviceLinkThroughputLimit` value does not increase frame rates.

Image format	Width [pixels]	Height [pixels]	ROI area [MP]	Frame rate [fps] <sup>1</sup>		
				450 MByte/s	375 MByte/s	200 MByte/s
Full resolution	4112	3008	12.369	23.0/17.5	23.0/14.8	15.7/7.9
UHD 4K	3840	2160	8.294	31.7/25.8	31.7/21.8	23.3/11.7
QSXGA	2560	2048	5.243	33.5/33.5		33.5/18.5
WQHD	2560	1440	3.686	47.0/47.0		47.0/26.0
QXGA	2048	1536	3.146	44.3/44.3		44.3/30.5
Full HD	1920	1080	2.074	62.0/62.0		62.0/45.5
UXGA	1600	1200	1.92	56.3/56.3		56.3/49.5
WXGA+	1440	900	1.296	73.9/73.9		73.9/71.9
SXGA	1280	1024	1.311	65.5/65.5		
HD 720	1280	720	0.922	91.1/91.1		
XGA	1024	768	0.786	86.0/86.0		
SVGA	800	600	0.48	108.2/108.2		
VGA	640	480	0.307	132.9/132.9		
HVGA	480	320	0.154	190.2/190.2		
QVGA	320	240	0.077	242.7/242.7		
HQVGA	240	160	0.038	335.5/335.5		
QQVGA	160	120	0.019	413.5/413.5		
Max. × half	4112	1504	6.184	44.7/34.2	44.7/28.8	30.8/15.5
Max. × min.	4112	8	0.033	756.6/635.8	756.6/561.7	591.8/347.3
Min. × max.	8	3008	0.024	23.2/23.2		
Min. × min.	8	8	64 P	1185.3/1185.3		

<sup>1</sup> Mono8 or Bayer...8<sup>(2)</sup> at `SensorBitDepth` = 12-Bit / Mono12 or Bayer...12 at `SensorBitDepth` = 12-Bit

<sup>2</sup> The three dots... represent the colors of a Bayer pixel format, such as in BayerRG8.

Table 79: Alvium 1800 U-1236m/c ROI frame rates

## Alvium 1800 U-1240m/c

Feature	Specification	
	1800 U-1240m (monochrome)	1800 U-1240c (color)
Sensor model	Sony IMX226	
Resolution	4024 (H) x 3036 (V); 12.2 MP	
Sensor type	CMOS	
Shutter type	Rolling shutter (RS) or Global reset shutter (GRS)	
Sensor size	Type 1/1.7; 7.4 mm x 5.6 mm; 9.3 mm diagonal	
Pixel size	1.85 $\mu\text{m}$ x 1.85 $\mu\text{m}$	
CRA	0 deg	
Sensor bit depth (ADC)	10-bit	
Monochrome pixel formats	Mono8 (default), Mono10, Mono10p, Mono12, Mono12p	Mono8, Mono10, Mono10p, Mono12, Mono12p
YUV color pixel formats	Not applicable	YCbCr411_8_CbYYCrYY, YCbCr422_8_CbYCrY, YCbCr8_CbYCr
RGB color pixel formats	Not applicable	BGR8, RGB8 (default)
Raw color pixel formats	Not applicable	BayerRG8, BayerRG10, BayerRG10p, BayerRG12, BayerRG12p
Maximum frame rate	35 fps <sup>1</sup> (at 450 MByte/s)	
Exposure time	11 $\mu\text{s}$ to 10 s (450 MByte/s)	
Exposure modes	Timed	
Gain	0 dB to 27 dB; 0.1 dB increments	
Digital binning <sup>2</sup>	Horizontal: 1 to 8 columns; Vertical: 1 to 8 rows	
Image buffer (RAM)	256 KByte	
Non-volatile memory (Flash)	1024 KByte	
GPIOs	4 programmable GPIOs As direct inputs (push-pull): 0 to 5.5 VDC As direct outputs (push-pull): 0 to 3.3 VDC at 12 mA	
Power requirements	Power over USB; External power	
Power consumption (typical, at 5 VDC)	USB power: 3.1 W External power: 3.3 W	
<sup>1</sup> In triggered mode: ~35 fps		
<sup>2</sup> Digital vertical binning can be used only when digital horizontal binning is used as well.		

Table 80: Alvium 1800 U-1240m/c specifications (sheet 1 of 2)

Feature	Specification			
	<b>1800 U-1240m/c</b>			
Storage temperature	-20 °C to +85 °C ambient temperature			
<b>Operating temperature</b>	<b>Hardware option</b>	<b>Housing</b>	<b>Cooling area<sup>2</sup></b>	<b>Mainboard<sup>3</sup></b>
	Bare board <sup>4</sup>	Not applicable	-20 °C to +85 °C	-20 °C to +88 °C
	Open housing <sup>5</sup>	-20 °C to +65 °C		
	Closed housing	-20 °C to +65 °C	Not applicable	
Relative humidity	0% to 80% (non-condensing)			
Digital interface	Micro-B USB 3.1 Gen 1 interface			
Camera controls	GenICam (GenICam Access)			

<sup>2</sup> See [Mounting the heat sink](#) on page 259.

<sup>3</sup> Output by DeviceTemperature

<sup>4</sup> Ensure that the sensor is operated in the temperature range specified by the manufacturer. For any questions, please visit [www.alliedvision.com/en/support](http://www.alliedvision.com/en/support).

<sup>5</sup> Temperature values must be observed for the housing **and** for the cooling area.

Table 80: Alvium 1800 U-1240m/c specifications (sheet 2 of 2)

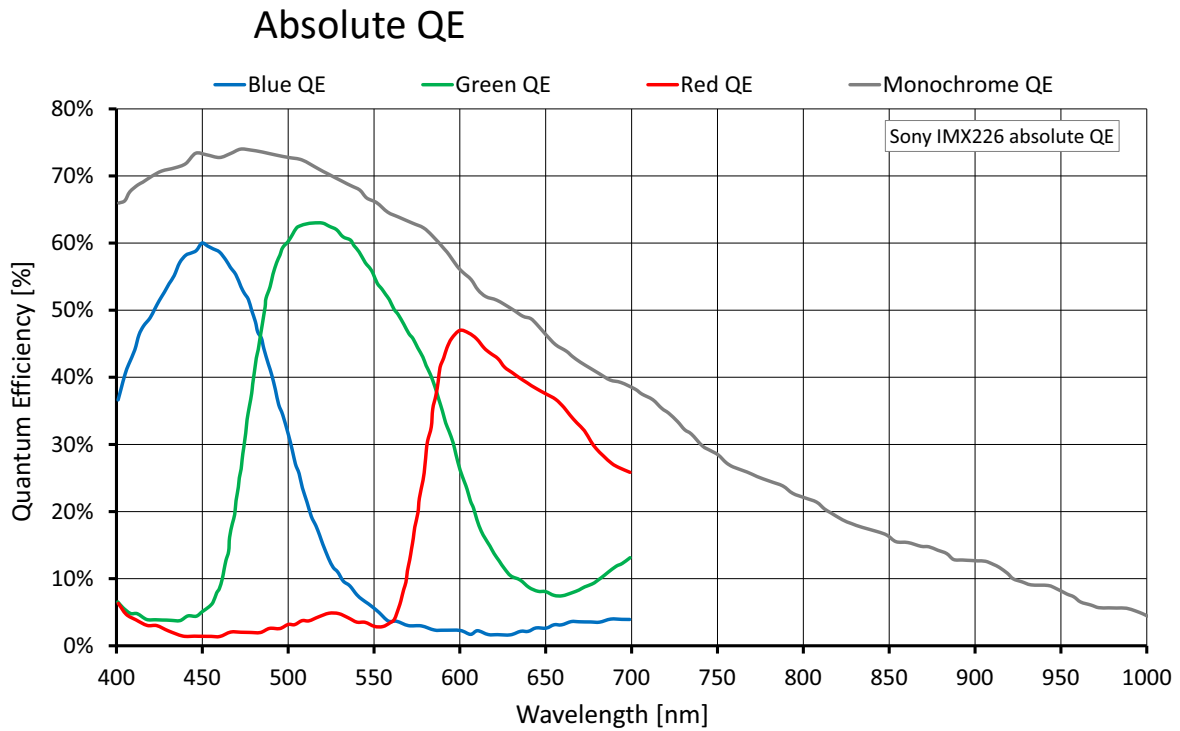

Figure 45: Alvium 1800 U-1240m/c (Sony IMX226) absolute QE

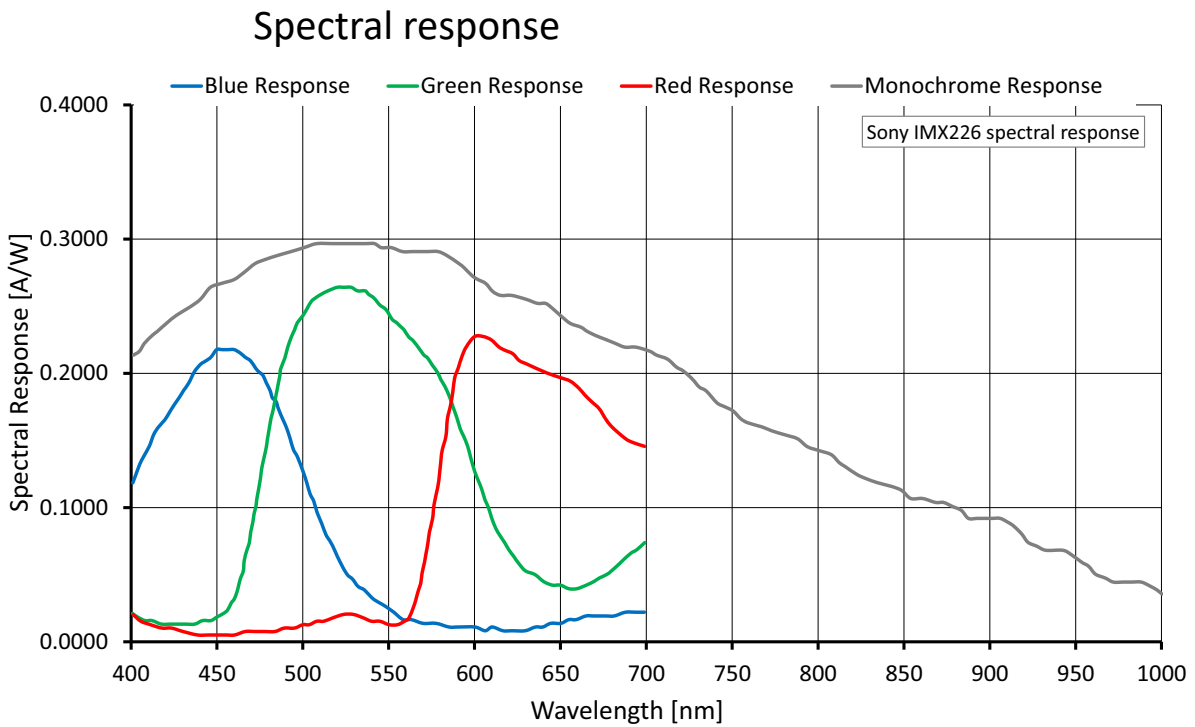

Figure 46: Alvium 1800 U-1240m/c (Sony IMX226) spectral response

## ROI frame rates

Values were measured for rolling shutter (RS) mode as defined in [Specified values](#) on page 67. Operation in global reset shutter mode produced identical values.

To reach the maximum frame rate available for this setup, the bandwidth for image traffic is 450 MByte/s.

Shutter mode	User mode	Available frame rates
Rolling shutter (RS)	Freerun	Values in <a href="#">Table 82</a> below are reached.
Rolling shutter (RS)	Triggered	>99% of the values for in <a href="#">Table 82</a> below are reached.
Global reset shutter (GRS)	Freerun	>99% of the values for in <a href="#">Table 82</a> below are reached.
Global reset shutter (GRS)	Triggered	

Table 81: Frame rate behavior for different configurations

Image format	Width [pixels]	Height [pixels]	ROI area [MP]	Frame rate [fps] <sup>1</sup>		
				450 MByte/s	375 MByte/s	200 MByte/s
Full resolution	4024	3036	12.217	35.0/17.7	29.7/15.0	16.0/8.0
UHD 4K	3840	2160	8.294			
QXGA	2560	2048	5.243			
WQHD	2560	1440	3.686			
QXGA	2048	1536	3.146			
Full HD	1920	1080	2.074			
UXGA	1600	1200	1.920			
WXGA+	1440	900	1.296			
SXGA	1280	1024	1.311			
HD 720	1280	720	0.922			
XGA	1024	768	0.786			
SVGA	800	600	0.480			
VGA	640	480	0.307			
HVGA	480	320	0.154			
QVGA	320	240	0.077			
HQVGA	240	160	0.038			
QQVGA	160	120	0.019			
Max. x half	4024	1518	6.108			
Max. x min.	4024	8	0.032			
Min. x max.	8	3036	0.024			
Min. x min.	8	8	64 P			

<sup>1</sup> Mono8 or Bayer...8<sup>(2)</sup> at SensorBitDepth = 10-Bit / Mono10 or Bayer...10 at SensorBitDepth = 10-Bit

<sup>2</sup> The three dots... represent the colors of a Bayer pixel format, such as in BayerRG8.

Table 82: Alvim 1800 U-1240m/c ROI frame rates

## Alvium 1800 U-1242m/c

Feature	Specification	
	1800 U-1242m (monochrome)	1800 U-1242c (color)
Sensor model	Sony IMX545	
Resolution	4128 (H) × 3008 (V); 12.4 MP	
Sensor type	CMOS	
Shutter type	Global shutter (GS)	
Sensor size	Type 1/1.1; 11.3 mm × 8.2 mm; 14.0 mm diagonal	
Pixel size	2.74 μm × 2.74 μm	
CRA	0 deg	
Sensor bit depth (ADC)	12-bit	
Monochrome pixel formats	Mono8 (default), Mono10, Mono10p, Mono12, Mono12p	Mono8, Mono10, Mono10p, Mono12, Mono12p
YUV color pixel formats	Not applicable	YCbCr411_8_CbYYCrYY, YCbCr422_8_CbYCrY, YCbCr8_CbYCr
RGB color pixel formats	Not applicable	BGR8, RGB8 (default)
Raw color pixel formats	Not applicable	BayerRG8, BayerRG10, BayerRG10p, BayerRG12, BayerRG12p
Maximum frame rate	33 fps (at 450 MByte/s)	
Exposure time	12 μs to 10 s (450 MByte/s)	
Exposure modes	Timed, TriggerControlled, TriggerWidth	
Gain	0 dB to 48 dB; 0.1 dB increments	
Digital binning <sup>1</sup>	Horizontal: 1 to 8 columns; Vertical: 1 to 8 rows	
Sensor binning (H × V)	2 × 2 ( <i>Sum</i> )	Not applicable
Multiple ROI (H × V)	<i>Free   Tile   Horizontal</i> : 1 × 1 to 1 × 4   <i>Vertical</i> : 1 × 1 to 4 × 1	
Image buffer (RAM)	256 KByte	
Non-volatile memory (Flash)	1024 KByte	
GPIOs	4 programmable GPIOs As direct inputs (push-pull): 0 to 5.5 VDC As direct outputs (push-pull): 0 to 3.3 VDC at 12 mA	
Power requirements	Power over USB; External power	
Power consumption (typical, at 5 VDC)	USB power: 3.4 W External power: 3.6 W	

<sup>1</sup> Digital vertical binning can be used only when digital horizontal binning is used as well.

Table 83: Alvium 1800 U-1242m/c specifications (sheet 1 of 2)



Feature	Specification			
	<b>1800 U-1242m/c</b>			
Storage temperature	-20 °C to +85 °C ambient temperature			
<b>Operating temperature</b>	<b>Hardware option</b>	<b>Housing</b>	<b>Cooling area<sup>1</sup></b>	<b>Mainboard<sup>2</sup></b>
	Bare board <sup>3</sup>	Not applicable	-20 °C to +85 °C	-20 °C to +85 °C
	Open housing <sup>4</sup>	-20 °C to +65 °C		
	Closed housing	-20 °C to +65 °C	Not applicable	
Relative humidity	0% to 80% (non-condensing)			
Digital interface	Micro-B USB 3.1 Gen 1 interface			
Camera controls	GenICam (GenICam Access)			
<sup>1</sup> See <a href="#">Mounting the heat sink</a> on page 259. <sup>2</sup> Output by DeviceTemperature <sup>3</sup> Ensure that the sensor is operated in the temperature range specified by the manufacturer. For any questions, please visit <a href="http://www.alliedvision.com/en/support">www.alliedvision.com/en/support</a> . <sup>4</sup> Temperature values must be observed for the housing <b>and</b> for the cooling area.				

Table 83: Alvium 1800 U-1242m/c specifications (sheet 2 of 2)

### Absolute QE

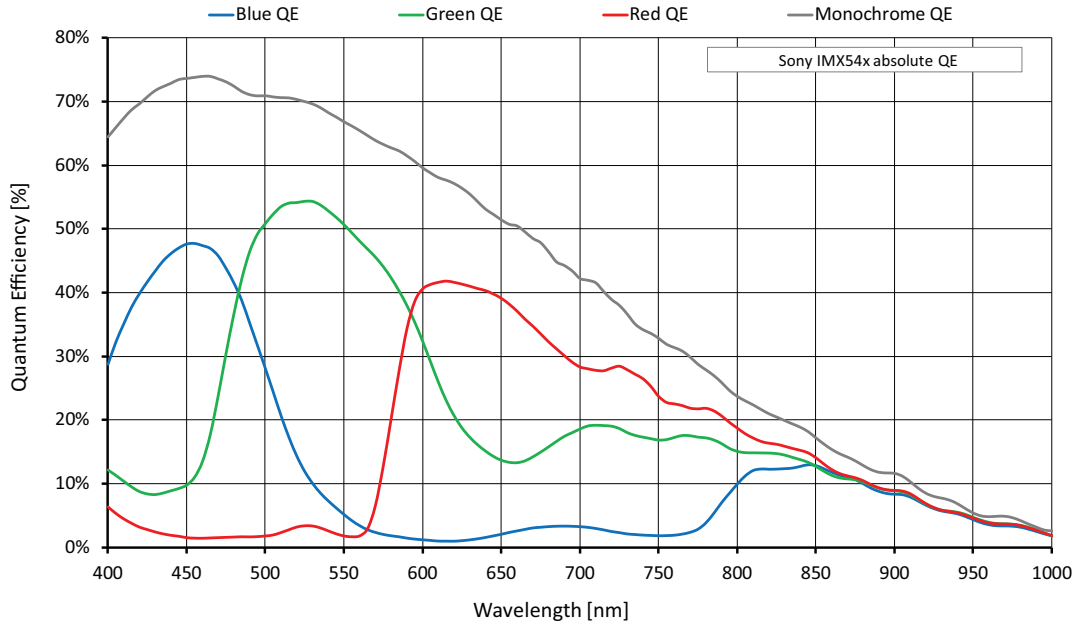

Figure 47: Alvium 1800 U-1242m/c (Sony IMX545) absolute QE

### Spectral response

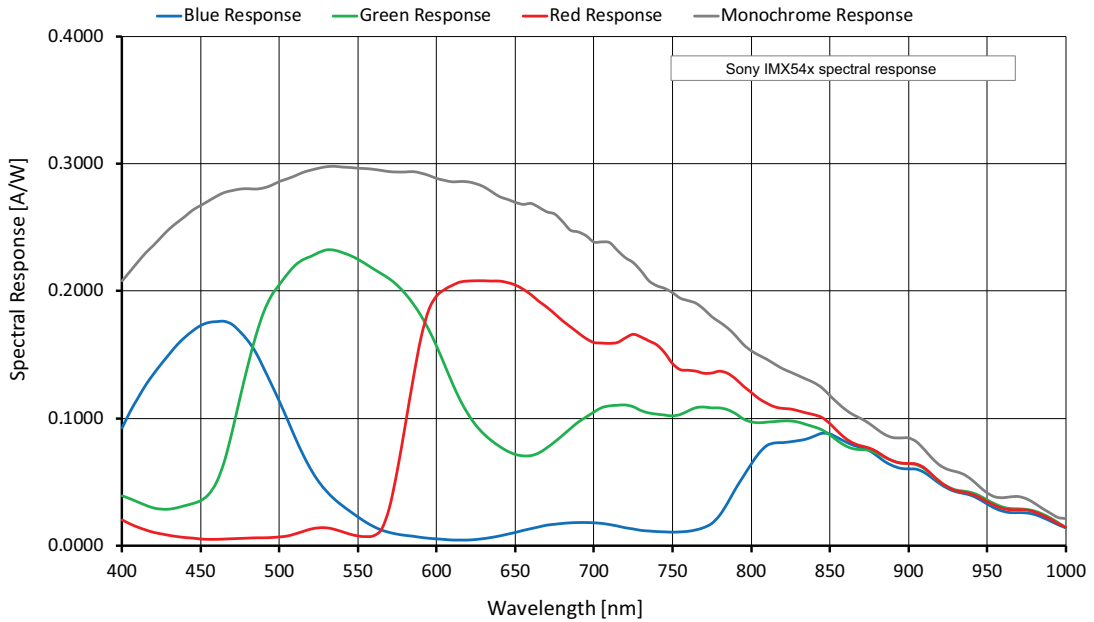

Figure 48: Alvium 1800 U-1242m/c (Sony IMX545) spectral response

## ROI frame rates

Values were measured as defined in [Specified values](#) on page 67.

To reach the maximum frame rate available for this setup, the bandwidth for image traffic is 450 MByte/s.

Image format	Width [pixels]	Height [pixels]	ROI area [MP]	Frame rate [fps] <sup>1</sup>		
				450 MByte/s	375 MByte/s	200 MByte/s
Full resolution	4128	3008	12.417	33.9/17.1	28.5/14.4	15.3/7.7
UHD 4K	3840	2160	8.294	49.7/25.0	41.7/21.1	22.5/11.3
QSXGA	2560	2048	5.243	59.0/39.4	59.0/33.2	35.4/17.8
WQHD	2560	1440	3.686	81.4/54.3	81.4/45.9	48.9/24.6
QXGA	2048	1536	3.146	77.1/64.2	77.1/54.1	57.5/29.0
Full HD	1920	1080	2.074	105.5/93.9	105.5/79.2	84.0/42.4
UXGA	1600	1200	1.92	96.5/96.5	96.5/86.3	92.0/46.4
WXGA+	1440	900	1.296	123.7/123.7	123.7/122.8	123.7/66.0
SXGA	1280	1024	1.311	111.2/111.2		111.2/66.7
HD 720	1280	720	0.922	149.9/149.9		149.9/90.1
XGA	1024	768	0.786	142.6/142.6		142.6/106.9
SVGA	800	600	0.48	175.0/175.0		175.0/167.0
VGA	640	480	0.307	209.2/209.2		
HVGA	480	320	0.154	281.7/281.7		
QVGA	320	240	0.077	340.4/340.4		
HQVGA	240	160	0.038	430.0/430.0		
QQVGA	160	120	0.019	495.2/495.2		
Max. × half	4128	1504	6.209	64.3/32.5	54.1/27.4	29.2/14.7
Max. × min.	4128	8	0.033	589.7/329.0	511.6/281.9	299.2/157.4
Min. × max.	8	3008	0.024	41.5/41.5		
Min. × min.	8	8	64 P	860.0/860.0		

<sup>1</sup> Mono8 or Bayer...8<sup>(2)</sup> at SensorBitDepth = 12-Bit / Mono12 or Bayer...12 at SensorBitDepth = 12-Bit

<sup>2</sup> The three dots... represent the colors of a Bayer pixel format, such as in BayerRG8.

Table 84: Alvium 1800 U-1242m/c ROI frame rates

## Alvium 1800 U-1620m/c

Feature	Specification	
	1800 U-1620m (monochrome)	1800 U-1620c (color)
Sensor model	Sony IMX542	
Resolution	5328 (H) × 3040 (V); 16.2 MP	
Sensor type	CMOS	
Shutter type	Global shutter (GS)	
Sensor size	Type 1.1; 14.6 mm × 8.3 mm; 16.8 mm diagonal	
Pixel size	2.74 μm × 2.74 μm	
CRA	0 deg	
Sensor bit depth (ADC)	12-bit	
Monochrome pixel formats	Mono8 (default), Mono10, Mono10p, Mono12, Mono12p	Mono8, Mono10, Mono10p, Mono12, Mono12p
YUV color pixel formats	Not applicable	YCbCr411_8_CbYYCrYY, YCbCr422_8_CbYCrY, YCbCr8_CbYCr
RGB color pixel formats	Not applicable	BGR8, RGB8 (default)
Raw color pixel formats	Not applicable	BayerRG8, BayerRG10, BayerRG10p, BayerRG12, BayerRG12p
Maximum frame rate	26 fps (at 450 MByte/s)	
Exposure time	15 μs to 10 s (450 MByte/s)	
Exposure modes	Timed, TriggerControlled, TriggerWidth	
Gain	0 dB to 48 dB; 0.1 dB increments	
Digital binning <sup>1</sup>	Horizontal: 1 to 8 columns; Vertical: 1 to 8 rows	
Sensor binning (H × V)	2 × 2 ( <i>Sum</i> )	Not applicable
Multiple ROI (H × V)	<i>Free   Tile   Horizontal</i> : 1 × 1 to 1 × 4   <i>Vertical</i> : 1 × 1 to 4 × 1	
Image buffer (RAM)	256 KByte	
Non-volatile memory (Flash)	1024 KByte	
GPIOs	4 programmable GPIOs As direct inputs (push-pull): 0 to 5.5 VDC As direct outputs (push-pull): 0 to 3.3 VDC at 12 mA	
Power requirements	Power over USB; External power	
Power consumption (typical, at 5 VDC)	USB power: 4.0 W External power: 4.2 W	

<sup>1</sup> Digital vertical binning can be used only when digital horizontal binning is used as well.

Table 85: Alvium 1800 U-1620m/c specifications (sheet 1 of 2)

Feature	Specification			
	<b>1800 U-1620m/c</b>			
Storage temperature	-20 °C to +85 °C ambient temperature			
<b>Operating temperature</b>	<b>Hardware option</b>	<b>Housing</b>	<b>Cooling area<sup>1</sup></b>	<b>Mainboard<sup>2</sup></b>
	Bare board <sup>3</sup>	Not applicable	-20 °C to +85 °C	-20 °C to +85 °C
	Open housing <sup>4</sup>	-20 °C to +65 °C		
	Closed housing	-20 °C to +65 °C	Not applicable	
Relative humidity	0% to 80% (non-condensing)			
Digital interface	Micro-B USB 3.1 Gen 1 interface			
Camera controls	GenICam (GenICam Access)			
<sup>1</sup> See <a href="#">Mounting the heat sink</a> on page 259. <sup>2</sup> Output by DeviceTemperature <sup>3</sup> Ensure that the sensor is operated in the temperature range specified by the manufacturer. For any questions, please visit <a href="http://www.alliedvision.com/en/support">www.alliedvision.com/en/support</a> . <sup>4</sup> Temperature values must be observed for the housing <b>and</b> for the cooling area.				

Table 85: Alvium 1800 U-1620m/c specifications (sheet 2 of 2)

### Absolute QE

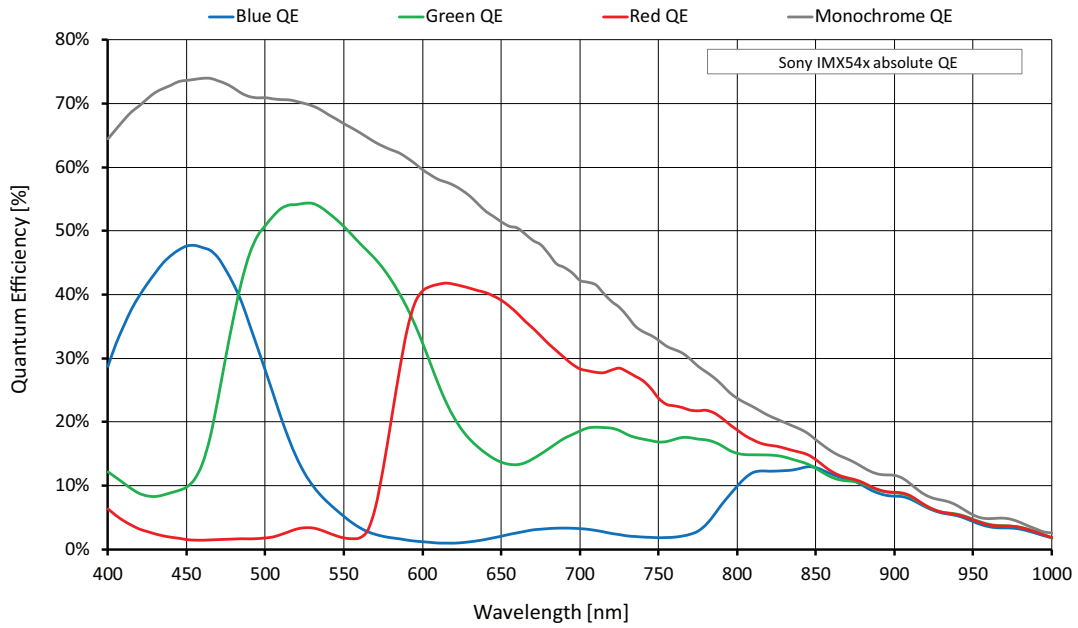

Figure 49: Alvium 1800 U-1620m/c (Sony IMX542) absolute QE

### Spectral response

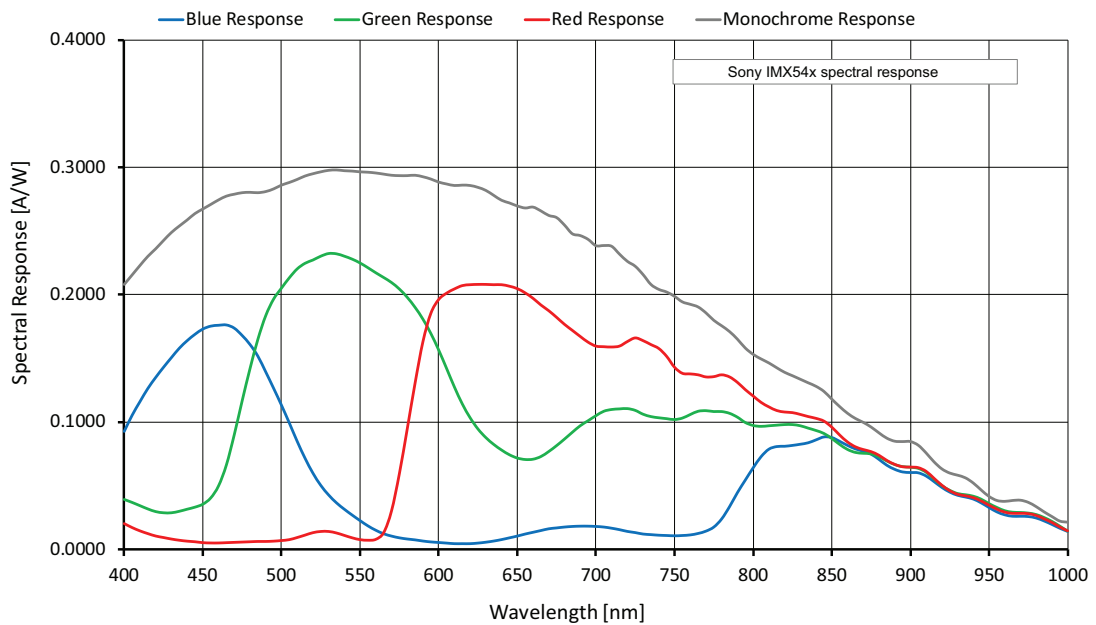

Figure 50: Alvium 1800 U-1620m/c (Sony IMX542) spectral response

## ROI frame rates

Values were measured as defined in [Specified values](#) on page 67.

To reach the maximum frame rate available for this setup, the bandwidth for image traffic is 450 MByte/s.

Image format	Width [pixels]	Height [pixels]	ROI area [MP]	Frame rate [fps] <sup>1</sup>		
				450 MByte/s	375 MByte/s	200 MByte/s
Full resolution	5328	3040	16.197	26.2/13.2	22.0/11.1	11.8/5.9
UHD 4K	3840	2160	8.294	44.6/25.3	42.1/21.3	22.7/11.4
QSXGA	2560	2048	5.243	47.1/39.7	47.1/33.5	35.7/18.0
WQHD	2560	1440	3.686	65.3/55.0	65.3/46.5	49.6/25.0
QXGA	2048	1536	3.146	61.7/61.7	61.7/54.8	58.2/29.4
Full HD	1920	1080	2.074	84.9/84.9	84.9/80.5	84.9/43.1
UXGA	1600	1200	1.92	77.5/77.5		77.5/47.1
WXGA+	1440	900	1.296	99.7/99.7		99.7/67.2
SXGA	1280	1024	1.311	89.4/89.4		89.4/67.8
HD 720	1280	720	0.922	121.5/121.5		121.5/92.2
XGA	1024	768	0.786	115.2/115.2		115.2/109.3
SVGA	800	600	0.48	142.2/142.2		
VGA	640	480	0.307	171.0/171.0		
HVGA	480	320	0.154	232.8/232.8		
QVGA	320	240	0.077	284.1/284.1		
HQVGA	240	160	0.038	364.4/364.4		
QQVGA	160	120	0.019	424.4/424.4		
Max. × half	5328	1520	8.099	49.9/25.2	42.1/21.3	22.7/11.4
Max. × min.	5328	8	0.043	513.0/290.3	447.8/249.3	264.1/140.1
Min. × max.	8	3040	0.024	32.6/32.6		
Min. × min.	8	8	64 P	787.2/787.2		

<sup>1</sup> Mono8 or Bayer...8<sup>(2)</sup> at SensorBitDepth = 12-Bit / Mono12 or Bayer...12 at SensorBitDepth = 12-Bit

<sup>2</sup> The three dots... represent the colors of a Bayer pixel format, such as in BayerRG8.

Table 86: Alvium 1800 U-1620m/c ROI frame rates

## Alvium 1800 U-2040m/c

Feature	Specification	
	1800 U-2040m (monochrome)	1800 U-2040c (color)
Sensor model	Sony IMX541	
Resolution	4512 (H) × 4512 (V); 20.4 MP	
Sensor type	CMOS	
Shutter type	Global shutter (GS)	
Sensor size	Type 1.1; 12.4 mm × 12.4 mm; 17.5 mm diagonal	
Pixel size	2.74 μm × 2.74 μm	
CRA	0 deg	
Sensor bit depth (ADC)	12-bit	
Monochrome pixel formats	Mono8 (default), Mono10, Mono10p, Mono12, Mono12p	Mono8, Mono10, Mono10p, Mono12, Mono12p
YUV color pixel formats	Not applicable	YCbCr411_8_CbYYCrYY, YCbCr422_8_CbYCrY, YCbCr8_CbYCr
RGB color pixel formats	Not applicable	BGR8, RGB8 (default)
Raw color pixel formats	Not applicable	BayerRG8, BayerRG10, BayerRG10p, BayerRG12, BayerRG12p
Maximum frame rate	21 fps (at 450 MByte/s)	
Exposure time	13 μs to 10 s (450 MByte/s)	
Exposure modes	Timed, TriggerControlled, TriggerWidth	
Gain	0 dB to 48 dB; 0.1 dB increments	
Digital binning <sup>1</sup>	Horizontal: 1 to 8 columns; Vertical: 1 to 8 rows	
Sensor binning (H × V)	2 × 2 ( <i>Sum</i> )	Not applicable
Multiple ROI (H × V)	<i>Free   Tile   Horizontal</i> : 1 × 1 to 1 × 4   <i>Vertical</i> : 1 × 1 to 4 × 1	
Image buffer (RAM)	256 KByte	
Non-volatile memory (Flash)	1024 KByte	
GPIOs	4 programmable GPIOs As direct inputs (push-pull): 0 to 5.5 VDC As direct outputs (push-pull): 0 to 3.3 VDC at 12 mA	
Power requirements	Power over USB; External power	
Power consumption (typical, at 5 VDC)	USB power: 3.9 W External power: 4.1 W	

<sup>1</sup> Digital vertical binning can be used only when digital horizontal binning is used as well.

Table 87: Alvium 1800 U-2040m/c specifications (sheet 1 of 2)



Feature	Specification			
	<b>1800 U-2040m/c</b>			
Storage temperature	-20 °C to +85 °C ambient temperature			
<b>Operating temperature</b>	<b>Hardware option</b>	<b>Housing</b>	<b>Cooling area<sup>1</sup></b>	<b>Mainboard<sup>2</sup></b>
	Bare board <sup>3</sup>	Not applicable	-20 °C to +85 °C	-20 °C to +85 °C
	Open housing <sup>4</sup>	-20 °C to +65 °C		
	Closed housing	-20 °C to +65 °C	Not applicable	
Relative humidity	0% to 80% (non-condensing)			
Digital interface	Micro-B USB 3.1 Gen 1 interface			
Camera controls	GenICam (GenICam Access)			

<sup>1</sup> See [Mounting the heat sink](#) on page 259.

<sup>2</sup> Output by DeviceTemperature

<sup>3</sup> Ensure that the sensor is operated in the temperature range specified by the manufacturer. For any questions, please visit [www.alliedvision.com/en/support](http://www.alliedvision.com/en/support).

<sup>4</sup> Temperature values must be observed for the housing **and** for the cooling area.

Table 87: Alvium 1800 U-2040m/c specifications (sheet 2 of 2)

## Absolute QE

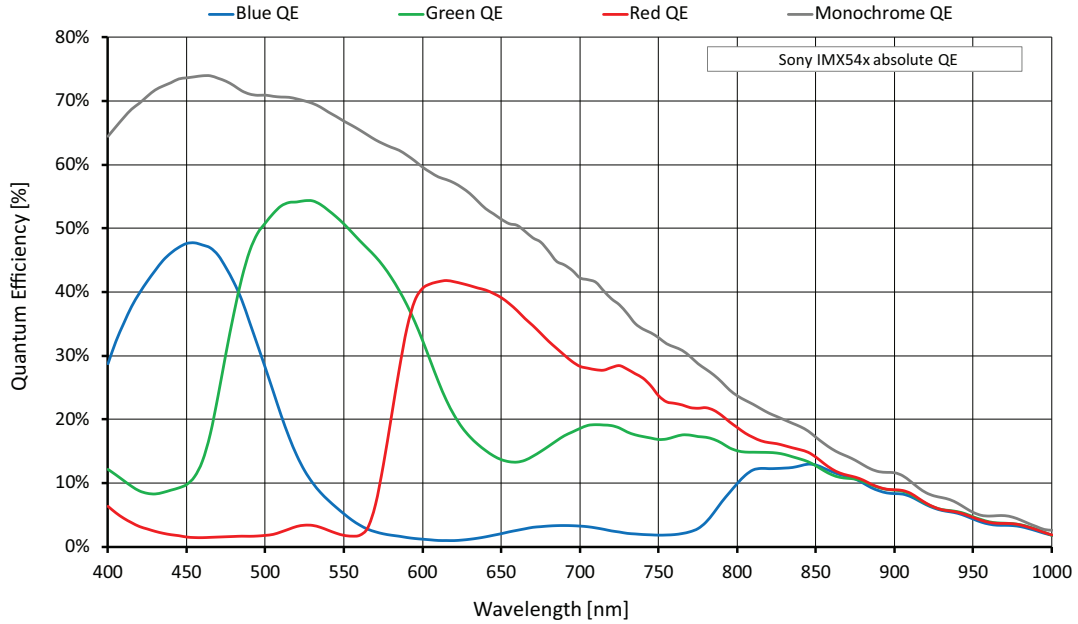

Figure 51: Alvium 1800 U-2040m/c (Sony IMX541) absolute QE

## Spectral response

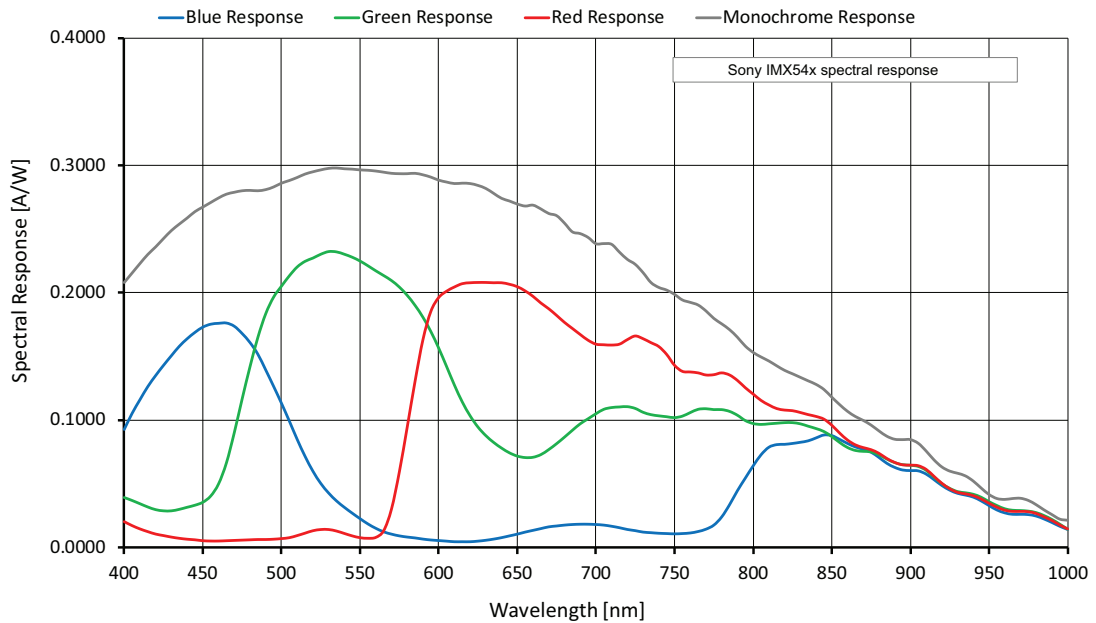

Figure 52: Alvium 1800 U-2040m/c (Sony IMX541) spectral response

## ROI frame rates

Values were measured as defined in [Specified values](#) on page 67.

To reach the maximum frame rate available for this setup, the bandwidth for image traffic is 450 MByte/s.

Image format	Width [pixels]	Height [pixels]	ROI area [MP]	Frame rate [fps] <sup>1</sup>		
				450 MByte/s	375 MByte/s	200 MByte/s
Full resolution	4512	4512	20.358	21.1/10.6	17.8/8.9	9.5/4.8
HXGA	4096	3072	12.583	33.6/16.9	28.4/14.3	15.2/7.6
UHD 4K	3840	2160	8.294	50.1/25.2	42.1/21.3	22.6/11.4
QSXGA	2560	2048	5.243	55.0/39.7	55.0/33.5	35.7/18.0
WQHD	2560	1440	3.686	76.0/55.0	76.0/46.4	49.5/24.9
QXGA	2048	1536	3.146	71.9/64.8	71.9/54.7	58.1/29.4
Full HD	1920	1080	2.074	98.9/95.3	98.9/80.4	85.3/43.0
UXGA	1600	1200	1.92	90.2/90.2	90.2/87.4	90.2/47.1
WXGA+	1440	900	1.296	116.1/116.1		116.1/67.1
SXGA	1280	1024	1.311	104.2/104.2		104.2/67.7
HD 720	1280	720	0.922	141.3/141.3		141.3/92.0
XGA	1024	768	0.786	134.2/134.2		134.2/109.0
SVGA	800	600	0.48	165.6/165.6		
VGA	640	480	0.307	198.9/198.9		
HVGA	480	320	0.154	270.3/270.3		
QVGA	320	240	0.077	329.3/329.3		
HQVGA	240	160	0.038	421.5/421.5		
QQVGA	160	120	0.019	490.0/490.0		
Max. × half	4512	2256	10.179	40.9/20.6	34.4/17.4	18.5/9.3
Max. × min.	4512	8	0.036	598.4/338.1	521.2/290.4	307.7/163.1
Min. × max.	8	4512	0.036	26.0/26.0		
Min. × min.	8	8	64 P	899.5/899.5		

<sup>1</sup> Mono8 or Bayer...8<sup>(2)</sup> at **SensorBitDepth** = 12-Bit / Mono12 or Bayer...12 at **SensorBitDepth** = 12-Bit

<sup>2</sup> The three dots... represent the colors of a Bayer pixel format, such as in Bayer**RG8**.

Table 88: Alvium 1800 U-2040m/c ROI frame rates

## Alvium 1800 U-2050m/c

Feature	Specification	
	1800 U-2050m (monochrome)	1800 U-2050c (color)
Sensor model	Sony IMX183	
Resolution	5496 (H) × 3672 (V); 20.2 MP	
Sensor type	CMOS	
Shutter type	Rolling shutter (RS) or Global reset shutter (GRS)	
Sensor size	Type 1; 13.1 mm × 8.8 mm; 15.9 mm diagonal	
Pixel size	2.4 μm × 2.4 μm	
CRA	3 deg	
Sensor bit depth (ADC)	10-bit	
Monochrome pixel formats	Mono8 (default), Mono10, Mono10p, Mono12, Mono12p	Mono8, Mono10, Mono10p, Mono12, Mono12p
YUV color pixel formats	Not applicable	YCbCr411_8_CbYYCrYY, YCbCr422_8_CbYCrY, YCbCr8_CbYCr
RGB color pixel formats	Not applicable	BGR8, RGB8 (default)
Raw color pixel formats	Not applicable	BayerRG8, BayerRG10, BayerRG10p, BayerRG12, BayerRG12p
Maximum frame rate	21 fps <sup>1</sup> (at 450 MByte/s)	
Exposure time	15 μs to 10 s (450 MByte/s)	
Exposure modes	Timed	
Gain	0 dB to 27 dB; 0.1 dB increments	
Digital binning <sup>2</sup>	Horizontal: 1 to 8 columns; Vertical: 1 to 8 rows	
Image buffer (RAM)	256 KByte	
Non-volatile memory (Flash)	1024 KByte	
GPIOs	4 programmable GPIOs As direct inputs (push-pull): 0 to 5.5 VDC As direct outputs (push-pull): 0 to 3.3 VDC at 12 mA	
Power requirements	Power over USB; External power	
Power consumption (typical, at 5 VDC)	USB power: 3.2 W External power: 3.4 W	

<sup>1</sup> In triggered mode: ~21 fps

<sup>2</sup> Digital vertical binning can be used only when digital horizontal binning is used as well.

Table 89: Alvium 1800 U-2050m/c specifications (sheet 1 of 2)

Feature	Specification			
	<b>1800 U-2050m/c</b>			
Storage temperature	-20 °C to +85 °C ambient temperature			
<b>Operating temperature</b>	<b>Hardware option</b>	<b>Housing</b>	<b>Cooling area<sup>2</sup></b>	<b>Mainboard<sup>3</sup></b>
	Bare board <sup>4</sup>	Not applicable	-20 °C to +85 °C	-20 °C to +88 °C
	Open housing <sup>5</sup>	-20 °C to +65 °C		
	Closed housing	-20 °C to +65 °C	Not applicable	
Relative humidity	0% to 80% (non-condensing)			
Digital interface	Micro-B USB 3.1 Gen 1 interface			
Camera controls	GenICam (GenICam Access)			

<sup>2</sup> See [Mounting the heat sink](#) on page 259.

<sup>3</sup> Output by DeviceTemperature

<sup>4</sup> Ensure that the sensor is operated in the temperature range specified by the manufacturer. For any questions, please visit [www.alliedvision.com/en/support](http://www.alliedvision.com/en/support).

<sup>5</sup> Temperature values must be observed for the housing **and** for the cooling area.

Table 89: Alvium 1800 U-2050m/c specifications (sheet 2 of 2)

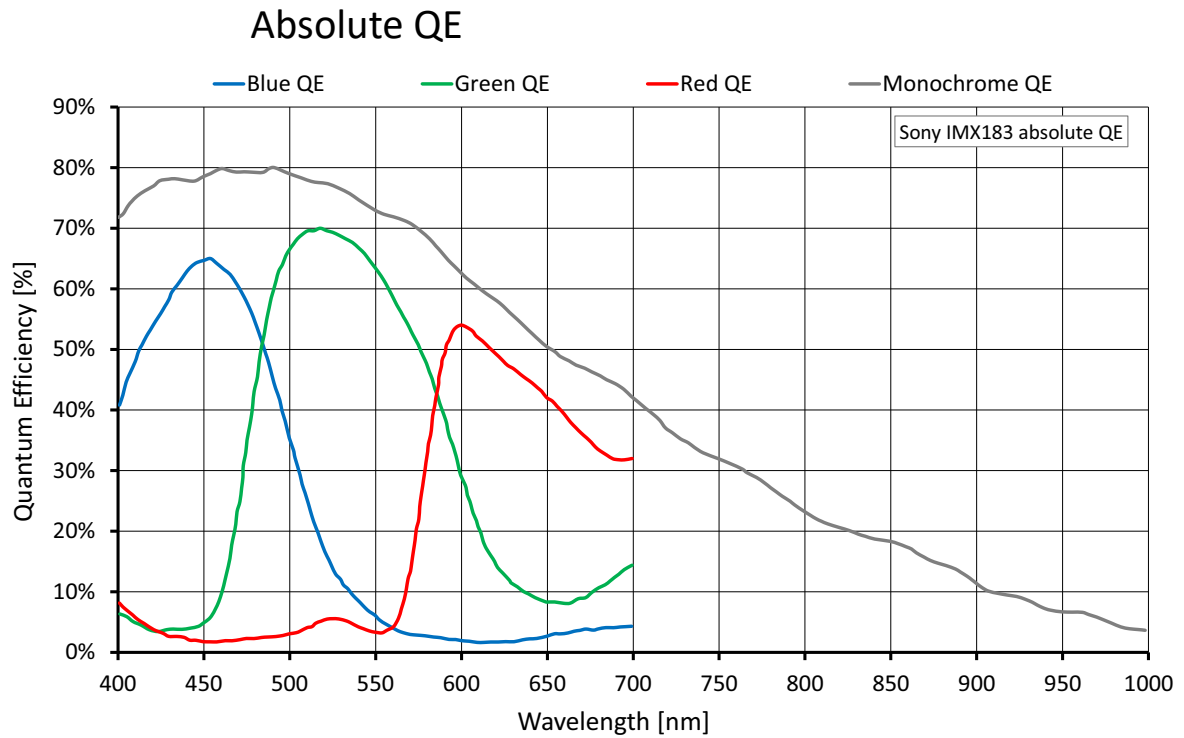

Figure 53: Alvium 1800 U-2050m/c (Sony IMX183) absolute QE

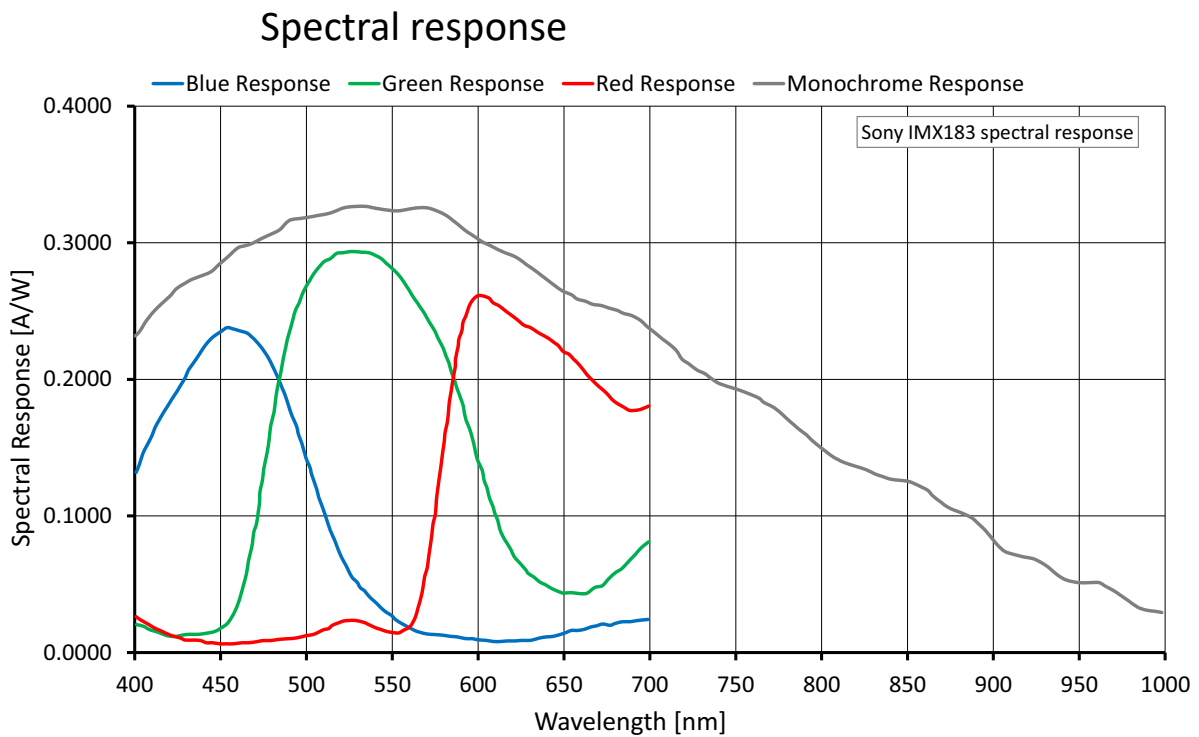

Figure 54: Alvium 1800 U-2050m/c (Sony IMX183) spectral response

## ROI frame rates

Values were measured for rolling shutter (RS) mode as defined in [Specified values](#) on page 67.

To reach the maximum frame rate available for this setup, the bandwidth for image traffic is 450 MByte/s.

Shutter mode	User mode	Available frame rates
Rolling shutter (RS)	Freerun	Values in <a href="#">Table 91</a> below are reached.
Rolling shutter (RS)	Triggered	>99% of the values for in <a href="#">Table 91</a> below are reached.
Global reset shutter (GRS)	Freerun	>99% of the values for in <a href="#">Table 91</a> below are reached.
Global reset shutter (GRS)	Triggered	

Table 90: Frame rate behavior for different configurations

Image format	Width [pixels]	Height [pixels]	ROI area [MP]	Frame rate [fps] <sup>1</sup>		
				450 MByte/s	375 MByte/s	200 MByte/s
Full resolution	5496	3672	20.181	21.4/10.7	18.1/9.1	9.7/4.9
HXGA	4096	3072	12.583	25.4/12.8	21.5/10.8	11.5/5.8
UHD 4K	3840	2160	8.294	35.6/18.0	30.1/15.2	16.2/8.1
QSXGA	2560	2048	5.243	37.4/18.9	31.7/16.0	17.0/8.6
WQHD	2560	1440	3.686	41.2/20.9	34.9/17.6	18.8/9.5
QXGA	2048	1536	3.146			
Full HD	1920	1080	2.074			
UXGA	1600	1200	1.92			
WXGA+	1440	900	1.296			
SXGA	1280	1024	1.311			
HD 720	1280	720	0.922			
XGA	1024	768	0.786			
SVGA	800	600	0.48			
VGA	640	480	0.307			
HVGA	480	320	0.154			
QVGA	320	240	0.077			
HQVGA	240	160	0.038			
QQVGA	160	120	0.019			
Max. × half	5496	1836	10.091			
Max. × min.	5496	8	0.044			
Min. × max.	8	3672	0.029			
Min. × min.	8	8	64 P	41.2/20.9	34.9/17.6	17.7/9.5

<sup>1</sup> Mono8 or Bayer...8<sup>(2)</sup> at **SensorBitDepth** = 10-Bit / Mono10 or Bayer...10 at **SensorBitDepth** = 10-Bit

<sup>2</sup> The three dots... represent the colors of a Bayer pixel format, such as in BayerRG8.

Table 91: Alvium 1800 U-2050m/c ROI frame rates

## Alvium 1800 U-2460m/c

Feature	Specification	
	1800 U-2460m (monochrome)	1800 U-2460c (color)
Sensor model	Sony IMX540	
Resolution	5328 (H) × 4608 (V); 24.6 MP	
Sensor type	CMOS	
Shutter type	Global shutter (GS)	
Sensor size	Type 1.2; 14.6 mm × 12.6 mm; 19.3 mm diagonal	
Pixel size	2.74 μm × 2.74 μm	
CRA	0 deg	
Sensor bit depth (ADC)	12-bit	
Monochrome pixel formats	Mono8 (default), Mono10, Mono10p, Mono12, Mono12p	Mono8, Mono10, Mono10p, Mono12, Mono12p
YUV color pixel formats	Not applicable	YCbCr411_8_CbYYCrYY, YCbCr422_8_CbYCrY, YCbCr8_CbYCr
RGB color pixel formats	Not applicable	BGR8, RGB8 (default)
Raw color pixel formats	Not applicable	BayerRG8, BayerRG10, BayerRG10p, BayerRG12, BayerRG12p
Maximum frame rate	17 fps (at 450 MByte/s)	
Exposure time	15 μs to 10 s (450 MByte/s)	
Exposure modes	Timed, TriggerControlled, TriggerWidth	
Gain	0 dB to 48 dB; 0.1 dB increments	
Digital binning <sup>1</sup>	Horizontal: 1 to 8 columns; Vertical: 1 to 8 rows	
Sensor binning (H × V)	2 × 2 ( <i>Sum</i> )	Not applicable
Multiple ROI (H × V)	<i>Free   Tile   Horizontal</i> : 1 × 1 to 1 × 4   <i>Vertical</i> : 1 × 1 to 4 × 1	
Image buffer (RAM)	256 KByte	
Non-volatile memory (Flash)	1024 KByte	
GPIOs	4 programmable GPIOs As direct inputs (push-pull): 0 to 5.5 VDC As direct outputs (push-pull): 0 to 3.3 VDC at 12 mA	
Power requirements	Power over USB; External power	
Power consumption (typical, at 5 VDC)	USB power: 4.0 W External power: 4.2 W	

<sup>1</sup> Digital vertical binning can be used only when digital horizontal binning is used as well.

Table 92: Alvium 1800 U-2460m/c specifications (sheet 1 of 2)



Feature	Specification			
	<b>1800 U-2460m/c</b>			
Storage temperature	-20 °C to +85 °C ambient temperature			
<b>Operating temperature</b>	<b>Hardware option</b>	<b>Housing</b>	<b>Cooling area<sup>2</sup></b>	<b>Mainboard<sup>3</sup></b>
	Bare board <sup>4</sup>	Not applicable	-20 °C to +85 °C	-20 °C to +85 °C
	Open housing <sup>5</sup>	-20 °C to +65 °C		
	Closed housing	-20 °C to +65 °C	Not applicable	
Relative humidity	0% to 80% (non-condensing)			
Digital interface	Micro-B USB 3.1 Gen 1 interface			
Camera controls	GenICam (GenICam Access)			
<sup>2</sup> See <a href="#">Mounting the heat sink</a> on page 259. <sup>3</sup> Output by DeviceTemperature <sup>4</sup> Ensure that the sensor is operated in the temperature range specified by the manufacturer. For any questions, please visit <a href="http://www.alliedvision.com/en/support">www.alliedvision.com/en/support</a> . <sup>5</sup> Temperature values must be observed for the housing <b>and</b> for the cooling area.				

*Table 92: Alvium 1800 U-2460m/c specifications (sheet 2 of 2)*

### Absolute QE

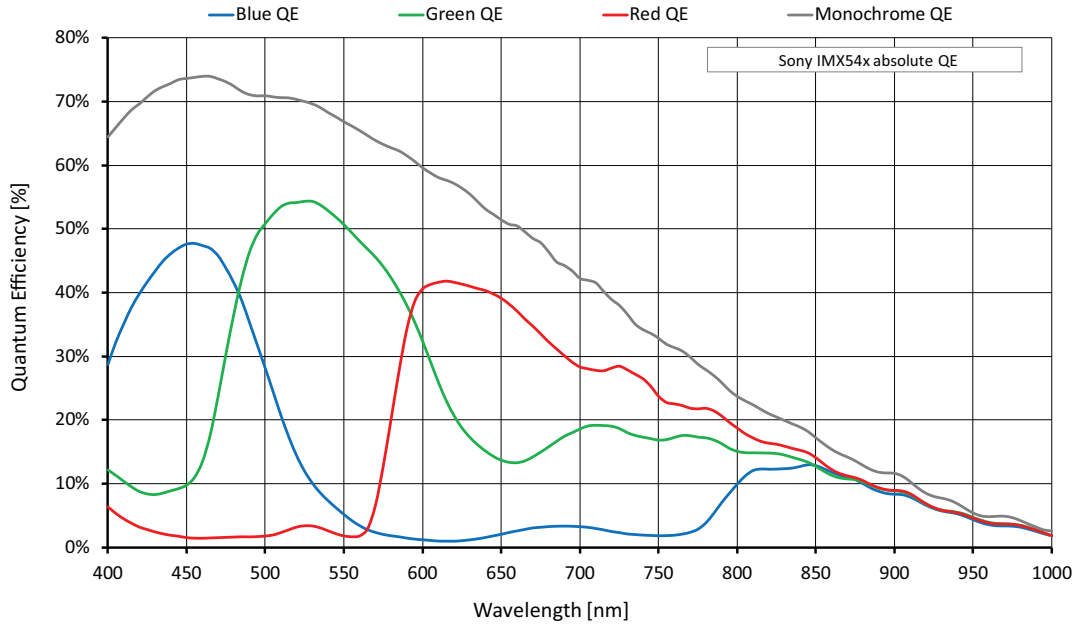

Figure 55: Alvium 1800 U-2460m/c (Sony IMX540) absolute QE

### Spectral response

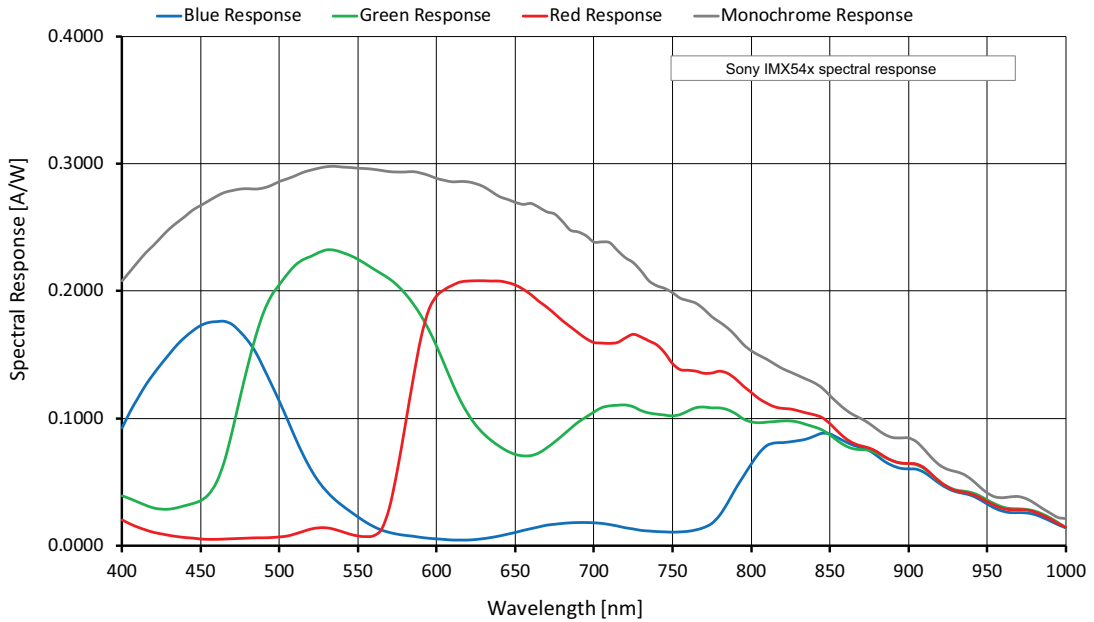

Figure 56: Alvium 1800 U-2460m/c (Sony IMX540) spectral response

## ROI frame rates

Values were measured as defined in [Specified values](#) on page 67.

To reach the maximum frame rate available for this setup, the bandwidth for image traffic is 450 MByte/s.

Image format	Width [pixels]	Height [pixels]	ROI area [MP]	Frame rate [fps] <sup>1</sup>		
				450 MByte/s	375 MByte/s	200 MByte/s
Full resolution	5328	4608	24.551	17.6/8.8	14.8/7.4	7.9/4.0
HSXGA	5120	4096	20.972	20.4/10.3	17.2/8.7	9.2/4.6
HXGA	4096	3072	12.583	32.0/16.9	28.4/14.3	15.2/7.6
UHD 4K	3840	2160	8.294	44.6/25.3	42.1/21.3	22.7/11.4
QSXGA	2560	2048	5.243	47.1/39.7	47.1/33.5	35.7/18.0
WQHD	2560	1440	3.686	65.3/55.0	65.3/46.5	49.6/25.0
QXGA	2048	1536	3.146	61.7/61.7	61.7/54.8	58.2/29.4
Full HD	1920	1080	2.074	84.9/84.9	84.9/80.5	84.9/43.1
UXGA	1600	1200	1.92	77.5/77.5		77.5/47.1
WXGA+	1440	900	1.296	99.7/99.7		99.7/67.2
SXGA	1280	1024	1.311	89.4/89.4		89.4/67.8
HD 720	1280	720	0.922	121.5/121.5		121.5/92.2
XGA	1024	768	0.786	115.2/115.2		115.2/109.3
SVGA	800	600	0.48	142.2/142.2		142.2/142.2
VGA	640	480	0.307	171.0/171.0		171.0/171.0
HVGA	480	320	0.154	232.8/232.8		
QVGA	320	240	0.077	284.1/284.1		
HQVGA	240	160	0.038	364.4/364.4		
QQVGA	160	120	0.019	424.4/424.4		
Max. × half	5328	2304	12.276	34.0/17.1	28.7/14.4	15.4/7.7
Max. × min.	5328	8	0.043	513.0/290.3	447.8/249.3	264.1/140.1
Min. × max.	8	4608	0.037	21.8/21.8	21.8/21.8	21.8/21.8
Min. × min.	8	8	64 P	787.2/787.2	787.2/787.2	787.2/787.2

<sup>1</sup> Mono8 or Bayer...8<sup>(2)</sup> at **SensorBitDepth** = 12-Bit /  
 Mono12 or Bayer...12 at **SensorBitDepth** = 12-Bit

<sup>2</sup> The three dots... represent the colors of a Bayer pixel format, such as in Bayer**RG8**.

Table 93: Alvium 1800 U-2460m/c ROI frame rates

## White balance default

Alvium color cameras are balanced for neutral color reproduction with an illumination of 5000 °K (warm daylight). [Table 94](#) shows default values for the red and blue channel by model.

For different illuminations, use auto white balance or adapt the color channel values manually.



### Feature description

See the Alvium Features Reference at [www.alliedvision.com/en/support/technical-documentation/alvium-usb-documentation](http://www.alliedvision.com/en/support/technical-documentation/alvium-usb-documentation).

Alvium model	Sensor model	Red channel value	Blue channel value
1800 U-040c	Sony IMX287	2.360	2.030
1800 U-050c	ON Semiconductor PYTHON 480	1.930	1.500
1800 U-052c	Sony IMX426	2.290	2.000
1800 U-120c	ON Semiconductor AR0135CS	1.760	1.650
1800 U-131c	e2v EV76C560	Tbd	Tbd
1800 U-158c	Sony IMX273	2.355	2.100
1800 U-192c	e2v EV76C570	Tbd	Tbd
1800 U-203c	Sony IMX422	2.290	2.000
1800 U-234c	Sony IMX249	2.580	1.810
1800 U-235c	Sony IMX174	2.580	1.810
1800 U-240c	Sony IMX392	2.355	2.100
1800 U-291c	Sony IMX421	2.290	2.000
1800 U-319c	Sony IMX265	2.355	2.100
1800 U-500c	ON Semiconductor AR0521SR	2.120	1.520
1800 U-501c NIR	ON Semiconductor AR0522	1.500	1.770
1800 U-507c	Sony IMX264	2.355	2.100
1800 U-507c Pol	Sony IMX264MYR	Not applicable	
1800 U-508c	Sony IMX250	2.355	2.100
1800 U-508c Pol	Sony IMX250MYR	Not applicable	
1800 U-510c	Sony IMX548	2.870	2.000
1800 U-511c	Sony IMX547	2.870	2.000
1800 U-811c	Sony IMX546	2.870	2.000
1800 U-895c	Sony IMX267	2.355	2.100
1800 U-1236c	Sony IMX304	2.355	2.100
1800 U-1240c	Sony IMX226	2.620	1.810
1800 U-1242c	Sony IMX545	2.870	2.000
1800 U-1620c	Sony IMX542	2.870	2.000
1800 U-2040c	Sony IMX541	2.870	2.000
1800 U-2050c	Sony IMX183	2.660	1.830
1800 U-2460c	Sony IMX540	2.870	2.000

Table 94: Alvium default values for color channels

**Excluded models**

White balance default does not apply to monochrome and Pol models.

## Standard Alvium: Dimensions and mass

### Bare board

Feature	USB 180° (standard orientation)	USB 90°
Dimensions (L × W × H)	[Model specific] × 26 mm × 26 mm	[Model specific] × 30 mm × 26 mm
Mass	15 g	

Table 95: Standard Alvium - bare board dimensions and mass

### Open housing 180° (standard orientation)

Open housing	C-Mount	CS-Mount	S-Mount
Flange focal distance, optical	17.526 mm	12.526 mm	12.63 mm
Thread	1"-32tpi UNS-2B	1"-32tpi UNS-2B	M12 × 0.5 mm
Maximum protrusion <sup>1</sup>	13.6 mm	8.6 mm	11.0 mm
Body dimensions (L × W × H) in [mm]	30 × 29 × 29	25 × 29 × 29	25 × 29 × 29
Mass	45 g		

<sup>1</sup> For details, see [Maximum protrusion for front mounts](#).

Table 96: Standard Alvium - open housing 180° dimensions and mass

### Open housing 90°

USB 90° open housing	C-Mount	CS-Mount	S-Mount
Flange focal distance, optical	17.526 mm	12.526 mm	12.63 mm
Thread	1"-32tpi UNS-2B	1"-32tpi UNS-2B	M12 × 0.5 mm
Maximum protrusion <sup>1</sup>	13.6 mm	8.6 mm	11.0 mm
Body dimensions (L × W × H) in [mm]	30 × 32 × 29	25 × 32 × 29	25 × 32 × 29
Mass	50 g		

<sup>1</sup> For details, see [Maximum protrusion for front mounts](#).

Table 97: Standard Alvium - open housing 90° dimensions and mass

### Closed housing 180°

Closed housing	C-Mount	CS-Mount	S-Mount
Flange focal distance, optical	17.526 mm	12.526 mm	12.63 mm
Thread	1"-32tpi UNS-2B	1"-32tpi UNS-2B	M12 × 0.5 mm
Maximum protrusion <sup>1</sup>	13.6 mm	8.6 mm	11.0 mm
Body dimensions (L × W × H) in [mm]	38 × 29 × 29	33 × 29 × 29	33 × 29 × 29
Mass <sup>2</sup>	60 g		
Mass <sup>3</sup>	65 g		

<sup>1</sup> For details, see [Maximum protrusion for front mounts](#).

<sup>2</sup> Alvium 1800 U-040, -050, -120, -131, -192, -234, -235, -319, -500, -501, -507, -507 Pol

<sup>3</sup> Alvium 1800 U-030, -052, -130, -158, -203,-240, -291, -320 VSWIR, -508, -508 Pol, -510, -511, -520 VSWIR, -811, 812, -895, -1236, -1240,-1242, -1620, -2040, -2050, -2460

Table 98: Standard Alvium - closed housing 180° dimensions and mass

### Closed housing 90°

USB 90° Closed housing	C-Mount	CS-Mount	S-Mount
Flange focal distance, optical	17.526 mm	12.526 mm	12.63 mm
Thread	1"-32tpi UNS-2B	1"-32tpi UNS-2B	M12 × 0.5 mm
Maximum protrusion <sup>1</sup>	13.6 mm	8.6 mm	11.0 mm
Body dimensions (L × W × H) in [mm]	38 × 32 × 29	33 × 32 × 29	33 × 32 × 29
Mass <sup>2</sup>	65 g		
Mass <sup>3</sup>	70 g		

<sup>1</sup> For details, see [Maximum protrusion for front mounts](#).

<sup>2</sup> Alvium 1800 U-040, -050, -120, -131, -192, -234, -235, -319, -500, -501, -507, -507 Pol

<sup>3</sup> Alvium 1800 U-030, -052, -130, -158, -203,-240, -291, -320 VSWIR, -508, -508 Pol, -510, -511, -520 VSWIR, -811, 812, -895, -1236, -1240,-1242, -1620, -2040, -2050, -2460

Table 99: Standard Alvium - closed housing 90° dimensions and mass

## Standard Alvium: Technical drawings

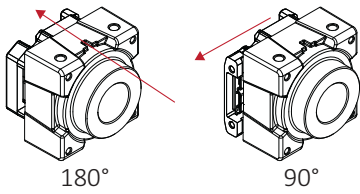



### USB interface connector position

- **180°**: The connector is at the camera backside. In the naming for camera hardware options, this option is **not mentioned**.
- **90°**: The connector is at the camera left side, as seen from the lens mount. In the naming for camera hardware options, this option is named **90°**.

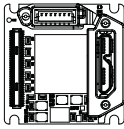
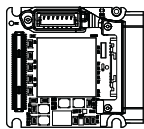
Standard Alvium USB cameras are available as shown in the following table:

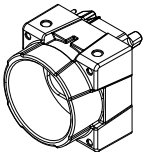
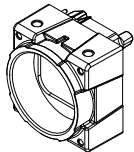
Bare Board	
180°	90°
	
page 208	page 208

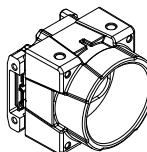
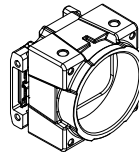
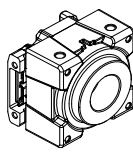
Open Housing					
180°			90°		
C-Mount	CS-Mount	S-Mount	C-Mount	CS-Mount	S-Mount
					
page 210	page 211	page 212	page 213	page 214	page 215

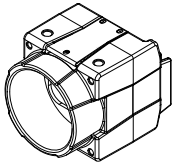
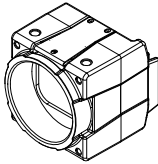
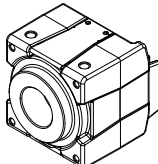
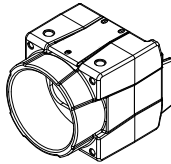
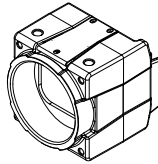
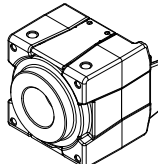
Closed Housing					
180°			90°		
C-Mount	CS-Mount	S-Mount	C-Mount	CS-Mount	S-Mount
					
page 216	page 217	page 218	page 219	page 220	page 221

## Bare Board 180° (standard Alvium)

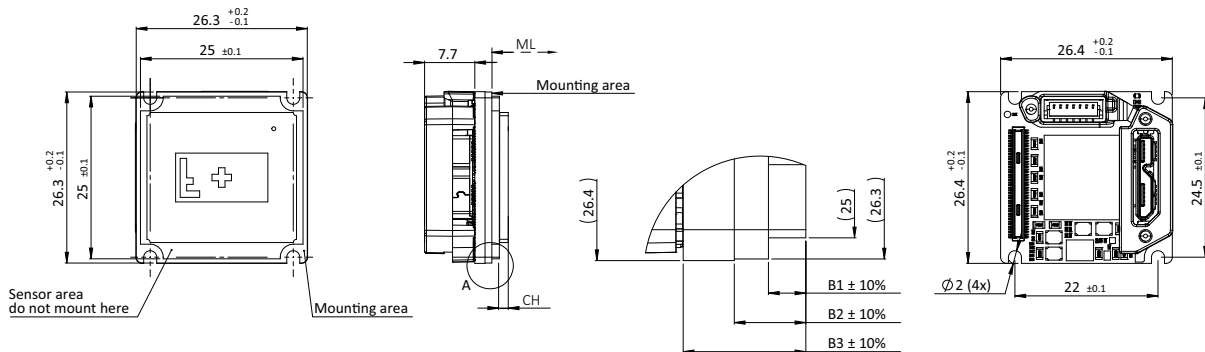

Figure 57: Bare Board 180° (standard Alvium) dimensions

## Bare Board 90° (standard Alvium)

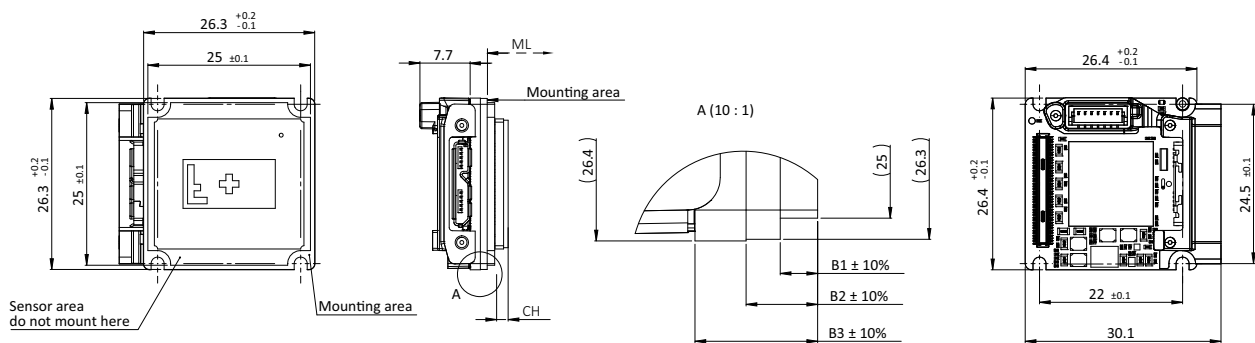

Figure 58: Bare Board 90° (standard Alvium) dimensions

## Values in Bare Board drawings

Dimensions that are common between different models are shown in [Figure 57](#) for **Bare Board Standard** and in [Figure 58](#) for **Bare Board 90°**.

Model specific dimensions are listed in [Table 100](#). **Mechanical length** (ML) defines the mechanical distance from the mounting area to the lens mount front flange, without optical filter. **Components height** (CH) relates to the electronic components with maximum height, in some cases the sensor.



### Mechanical length for S-Mount and CS-Mount

Mechanical length for other mounts is:

- CS-Mount: [C-Mount value] – 5 mm
- S-Mount: depending on your design.



Camera model	ML: Mechanical length* for C-Mount	CH: Components height, incl. the sensor	B1: Board thickness	B2: Board thickness	B3: Board thickness
Alvium 1800 U-030 VSWIR	19.613 mm	2.87 mm	1.25 mm	2.20 mm	3.75 mm
Alvium 1800 U-040m/c	19.879 mm	2.27 mm	1.20 mm	2.20 mm	3.75 mm
Alvium 1800 U-050m/c	19.604 mm	1.40 mm	1.75 mm	3.00 mm	4.55 mm
Alvium 1800 U-052m/c	19.713 mm	2.87 mm	1.10 mm	2.20 mm	3.75 mm
Alvium 1800 U-120m/c	19.689 mm	1.44 mm	1.25 mm	2.40 mm	3.95 mm
Alvium 1800 U-130 VSWIR	19.613 mm	2.87 mm	1.25 mm	2.20 mm	3.75 mm
Alvium 1800 U-131m/c	19.845 mm	2.59 mm	1.00 mm	2.00 mm	3.55 mm
Alvium 1800 U-158m/c	19.879 mm	2.27 mm	1.20 mm	2.20 mm	3.75 mm
Alvium 1800 U-192m/c	19.845 mm	2.59 mm	1.00 mm	2.00 mm	3.55 mm
Alvium 1800 U-203m/c	19.713 mm	2.87 mm	1.10 mm	2.20 mm	3.75 mm
Alvium 1800 U-234m/c	19.713 mm	2.87 mm	1.10 mm	2.20 mm	3.75 mm
Alvium 1800 U-235m/c	19.713 mm	2.87 mm	1.10 mm	2.20 mm	3.75 mm
Alvium 1800 U-240m/c	19.929 mm	2.27 mm	1.25 mm	2.20 mm	3.75 mm
Alvium 1800 U-291m/c	19.713 mm	2.87 mm	1.10 mm	2.20 mm	3.75 mm
Alvium 1800 U-319m/c	19.929 mm	2.27 mm	1.25 mm	2.20 mm	3.75 mm
Alvium 1800 U-320 VSWIR	19.713 mm	2.83 mm	1.10 mm	2.20 mm	3.75 mm
Alvium 1800 U-500m/c	19.739 mm	1.67 mm	1.30 mm	2.40 mm	3.95 mm
Alvium 1800 U-501m/c NIR	19.739 mm	1.67 mm	1.30 mm	2.40 mm	3.95 mm
Alvium 1800 U-507m/c	19.929 mm	2.27 mm	1.25 mm	2.20 mm	3.75 mm
Alvium 1800 U-507m/c Pol	19.929 mm	2.27 mm	1.25 mm	2.20 mm	3.75 mm
Alvium 1800 U-508m/c	19.929 mm	2.27 mm	1.25 mm	2.20 mm	3.75 mm
Alvium 1800 U-508m/c Pol	19.929 mm	2.27 mm	1.25 mm	2.20 mm	3.75 mm
Alvium 1800 U-510m/c	19.713mm	2.20 mm	1.10 mm	2.20 mm	3.75 mm
Alvium 1800 U-511m/c	19.613 mm	2.88 mm	1.00 mm	2.20 mm	3.75 mm
Alvium 1800 U-530 VSWIR	19.713 mm	2.83 mm	1.10 mm	2.20 mm	3.75 mm
Alvium 1800 U-811m/c	19.613 mm	2.88 mm	1.00 mm	2.20 mm	3.75 mm
Alvium 1800 U-812 UV	19.610 mm	2.88 mm	1.00 mm	2.20 mm	3.75 mm
Alvium 1800 U-895m/c	19.829 mm	2.27 mm	1.15 mm	2.20 mm	3.75 mm
Alvium 1800 U-1236m/c	19.829 mm	2.27 mm	1.15 mm	2.20 mm	3.75 mm
Alvium 1800 U-1240m/c	19.763 mm	2.20 mm	1.15 mm	2.20 mm	3.75 mm
Alvium 1800 U-1242m/c	19.613 mm	2.88 mm	1.00 mm	2.20 mm	3.75 mm
Alvium 1800 U-1620m/c	19.613 mm	2.88 mm	1.00 mm	2.20 mm	3.75 mm
Alvium 1800 U-2040m/c	19.613 mm	2.88 mm	1.00 mm	2.20 mm	3.75 mm
Alvium 1800 U-2050m/c	19.663 mm	2.87 mm	1.05 mm	2.20 mm	3.75 mm
Alvium 1800 U-2460m/c	19.613 mm	2.88 mm	1.00 mm	2.20 mm	3.75 mm
* Theoretical values					

*Table 100: Bare Board and Bare Board 90° (standard Alvium and Alvium Flex) model specific dimensions and nominal values*

## Open Housing C-Mount 180° (standard Alvium)

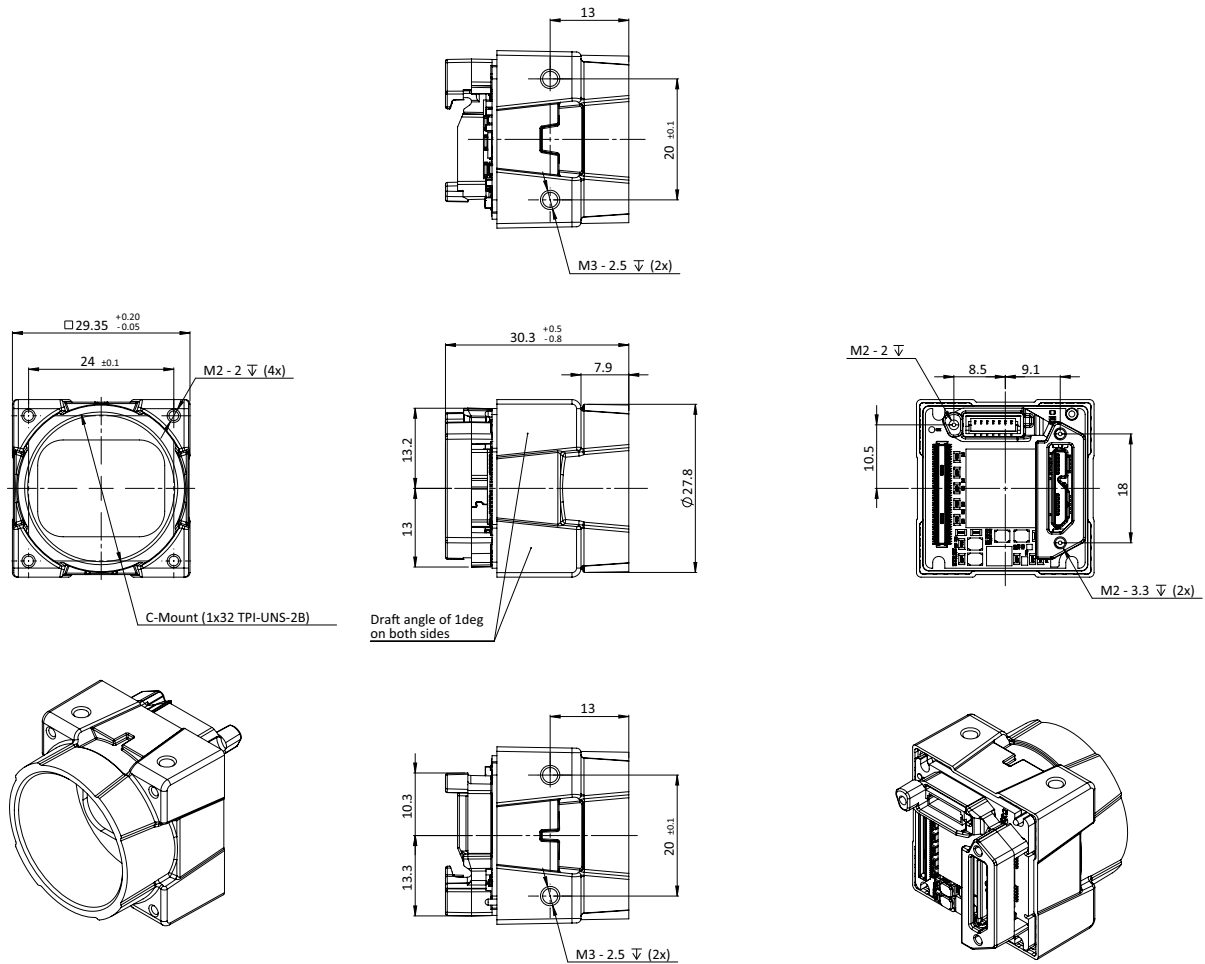

Figure 59: Open Housing C-Mount 180° (standard Alvium) dimensions

## Open Housing CS-Mount 180° (standard Alvium)

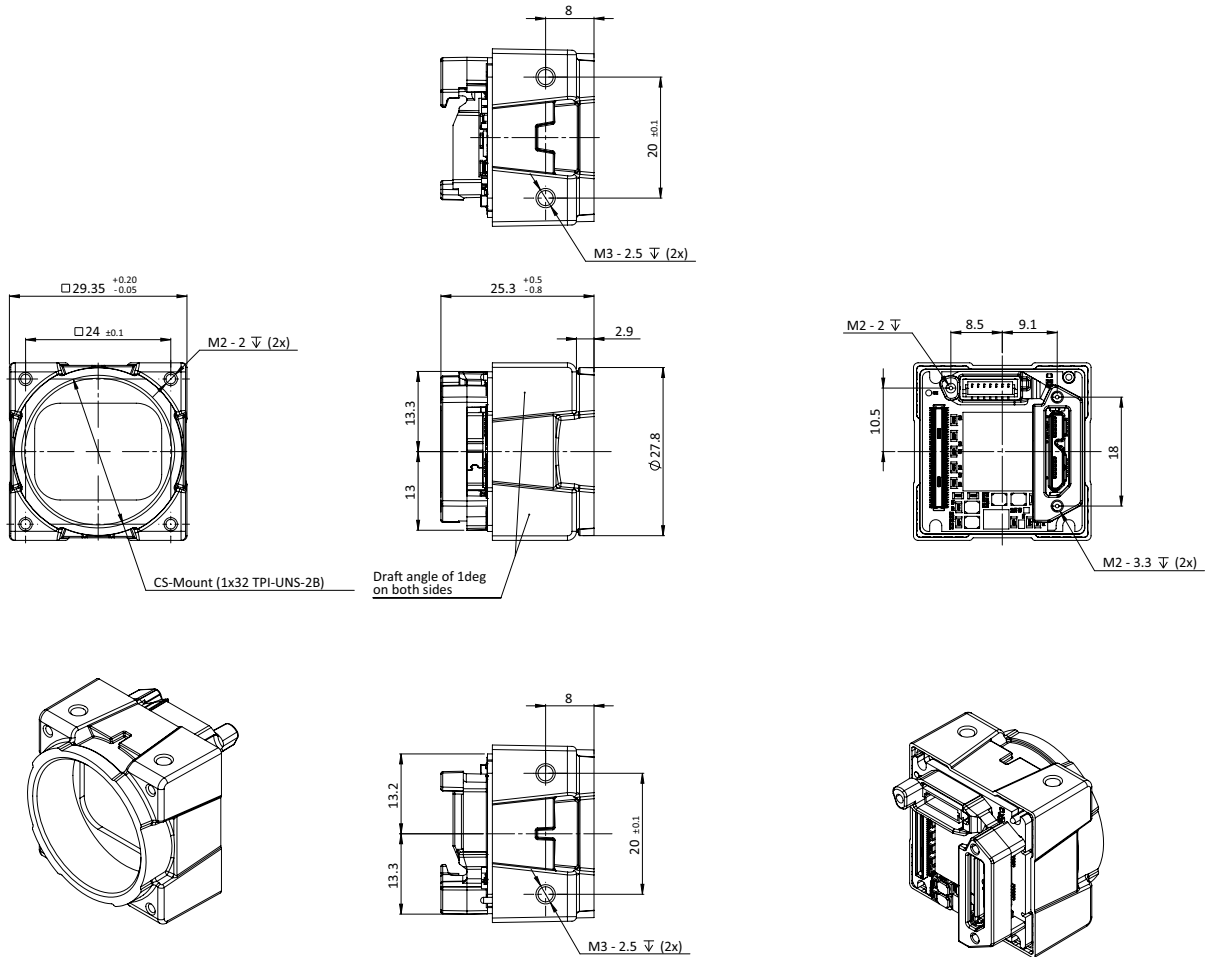

Figure 60: Open Housing CS-Mount 180° (standard Alvium) dimensions

## Open Housing S-Mount 180° (standard Alvium)

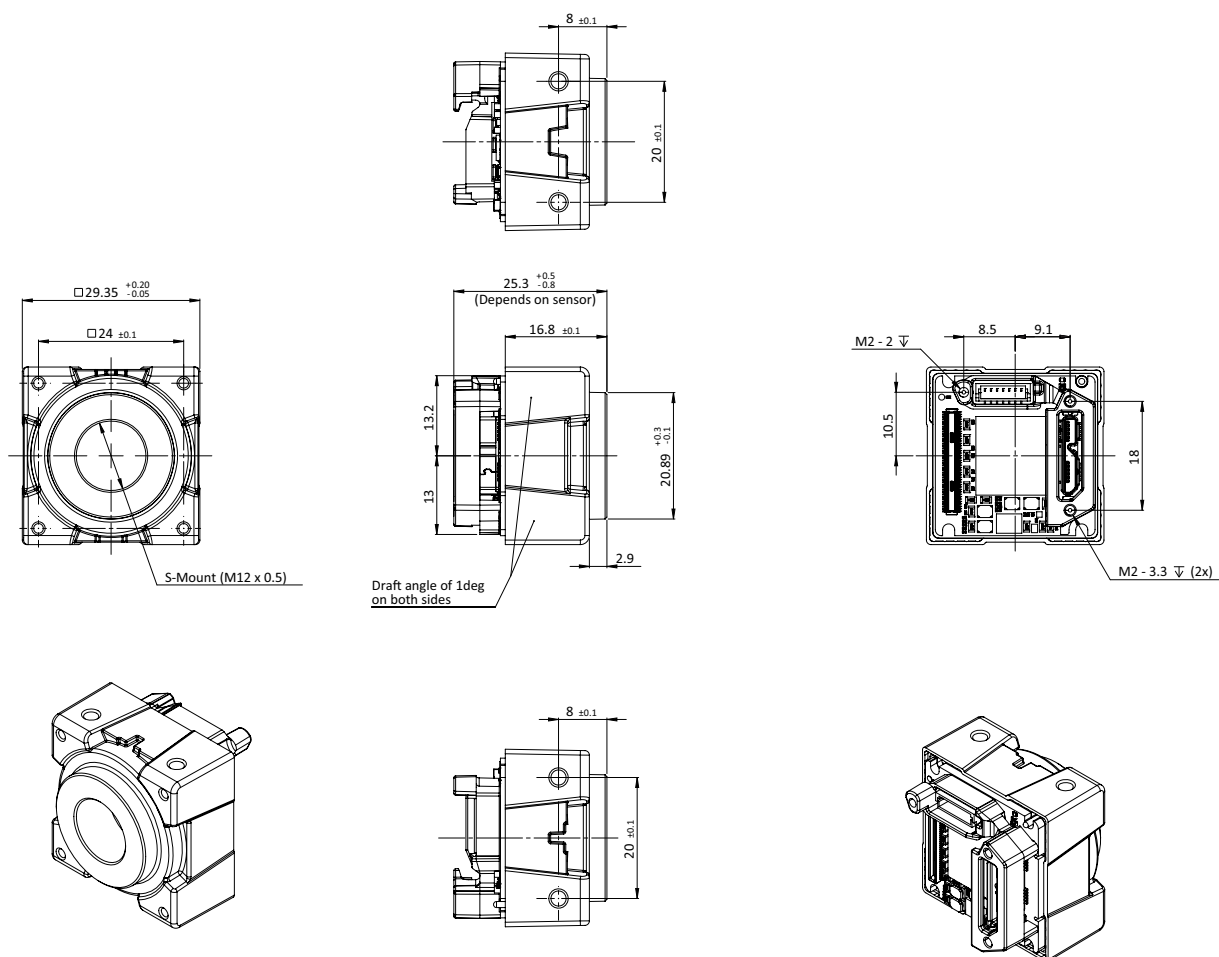

Figure 61: Open Housing S-Mount 180° (standard Alvium) dimensions

## Open Housing C-Mount 90° (standard Alvium)

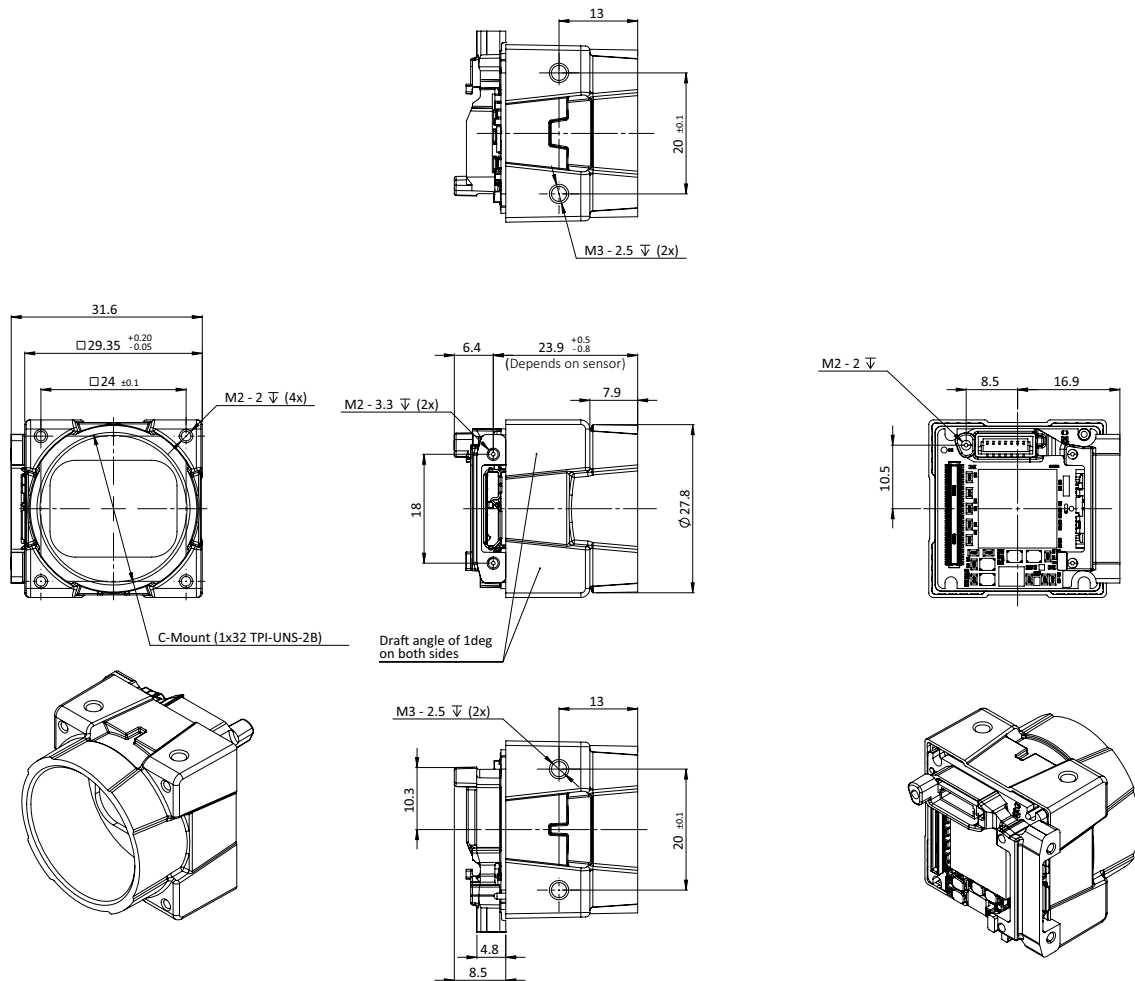

Figure 62: Open Housing C-Mount 90° (standard Alvium) dimensions

## Open Housing CS-Mount 90° (standard Alvium)

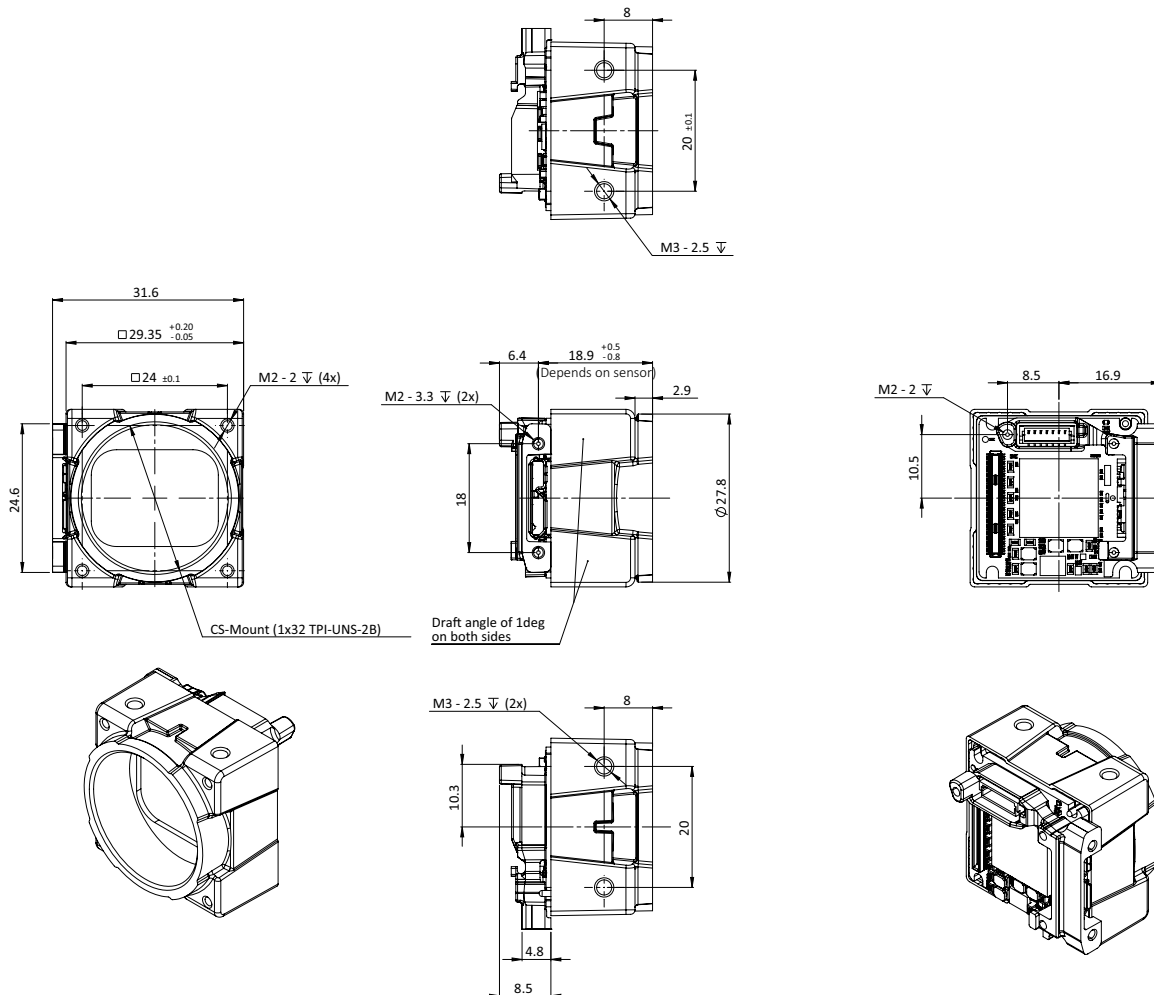

Figure 63: Open Housing CS-Mount 90° (standard Alvium) dimensions

## Open Housing S-Mount 90° (standard Alvium)

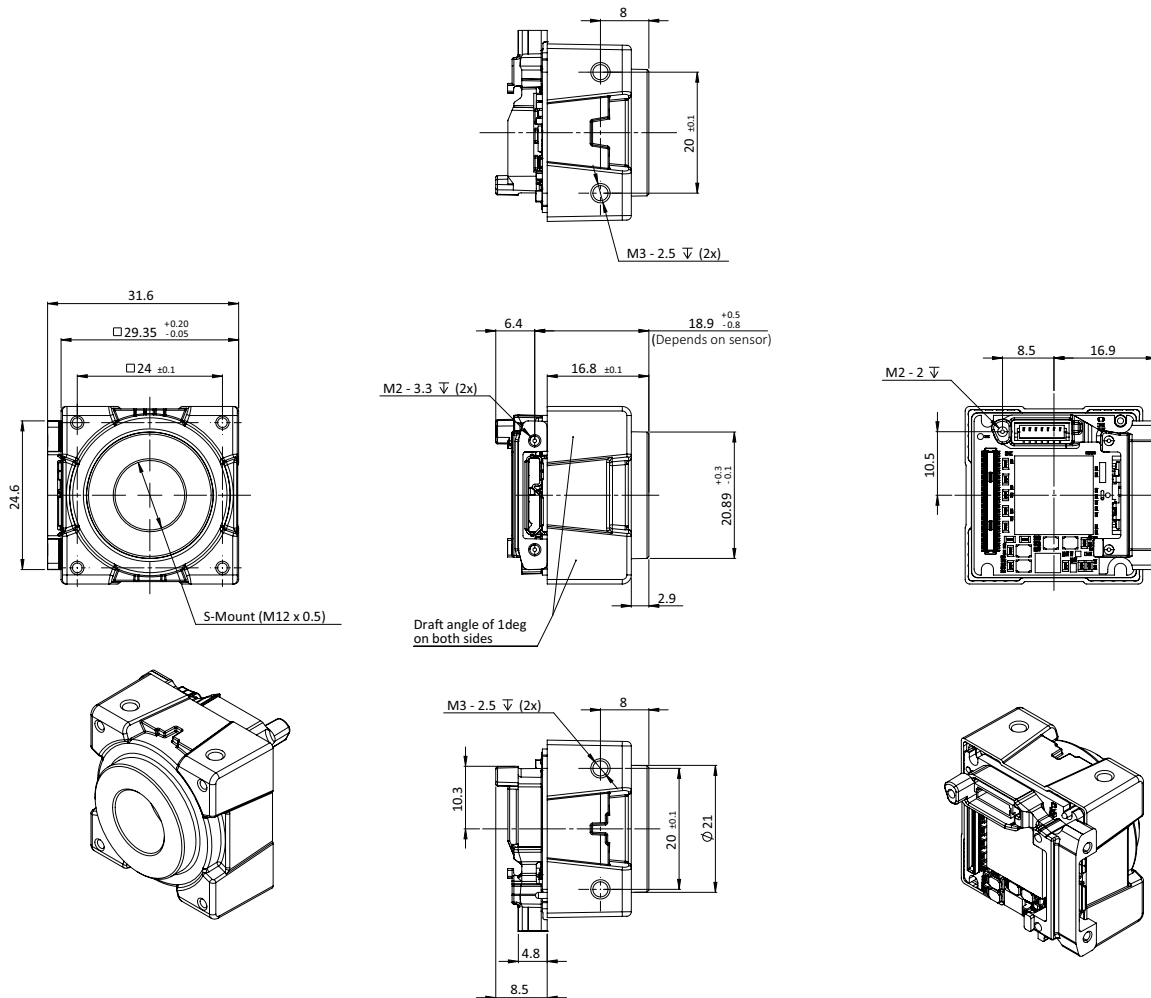

Figure 64: Open Housing S-Mount 90° (standard Alvium) dimensions

## Closed Housing C-Mount 180° (standard Alvium)

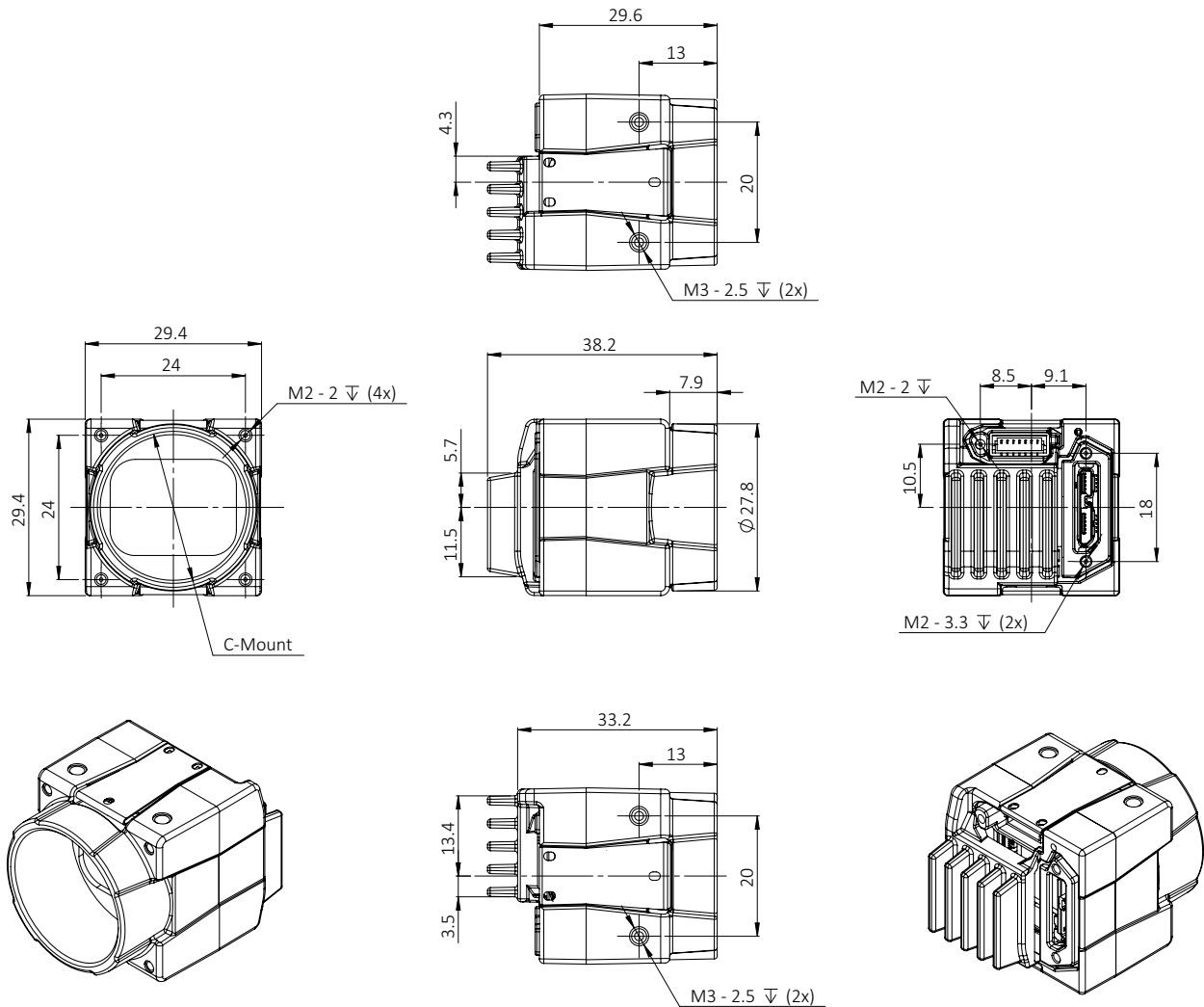

Figure 65: Closed Housing C-Mount 180° (standard Alvium) dimensions



## Closed Housing CS-Mount 180° (standard Alvium)

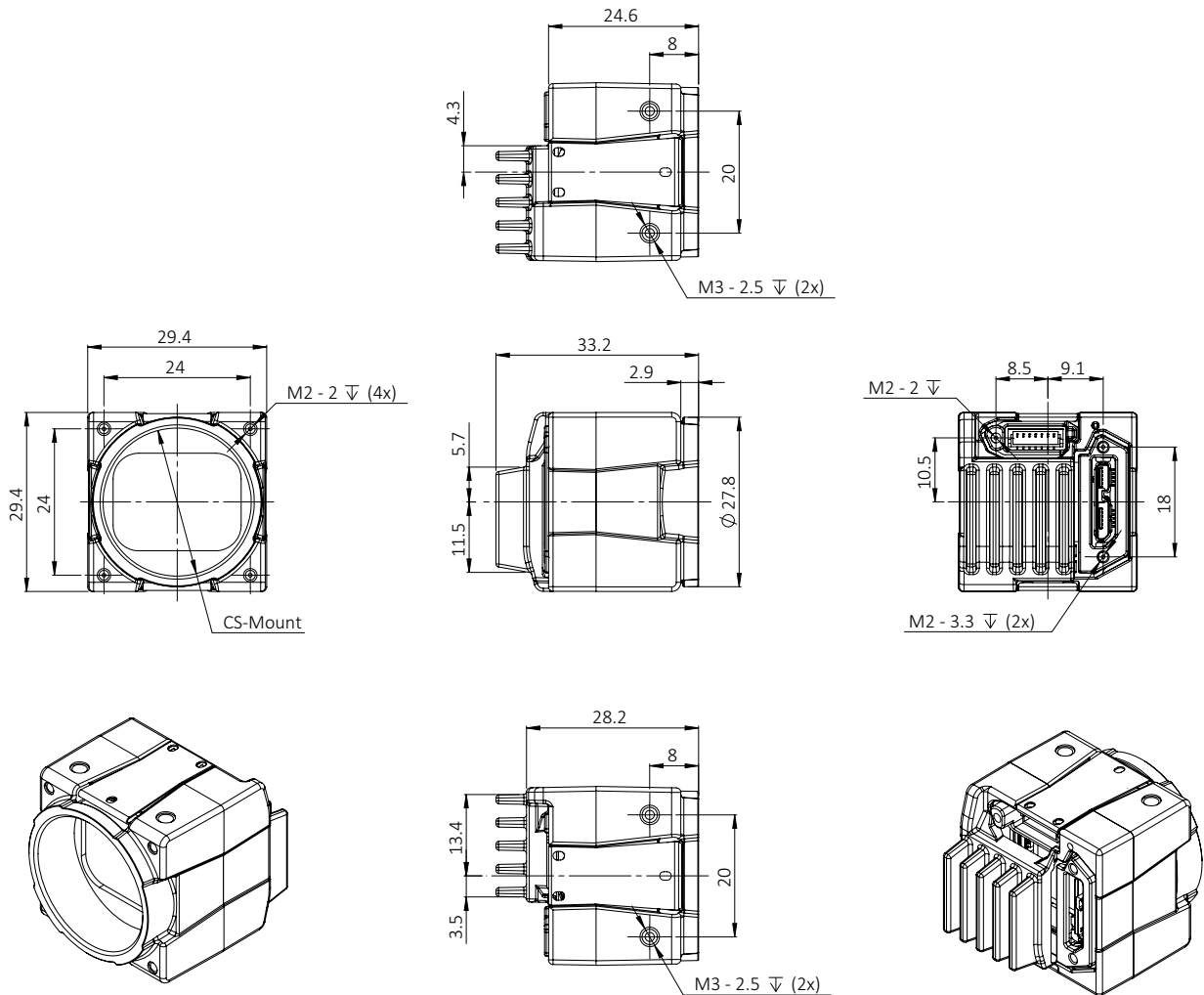

Figure 66: Closed Housing CS-Mount 180° (standard Alvium) dimensions

## Closed Housing S-Mount 180° (standard Alvium)

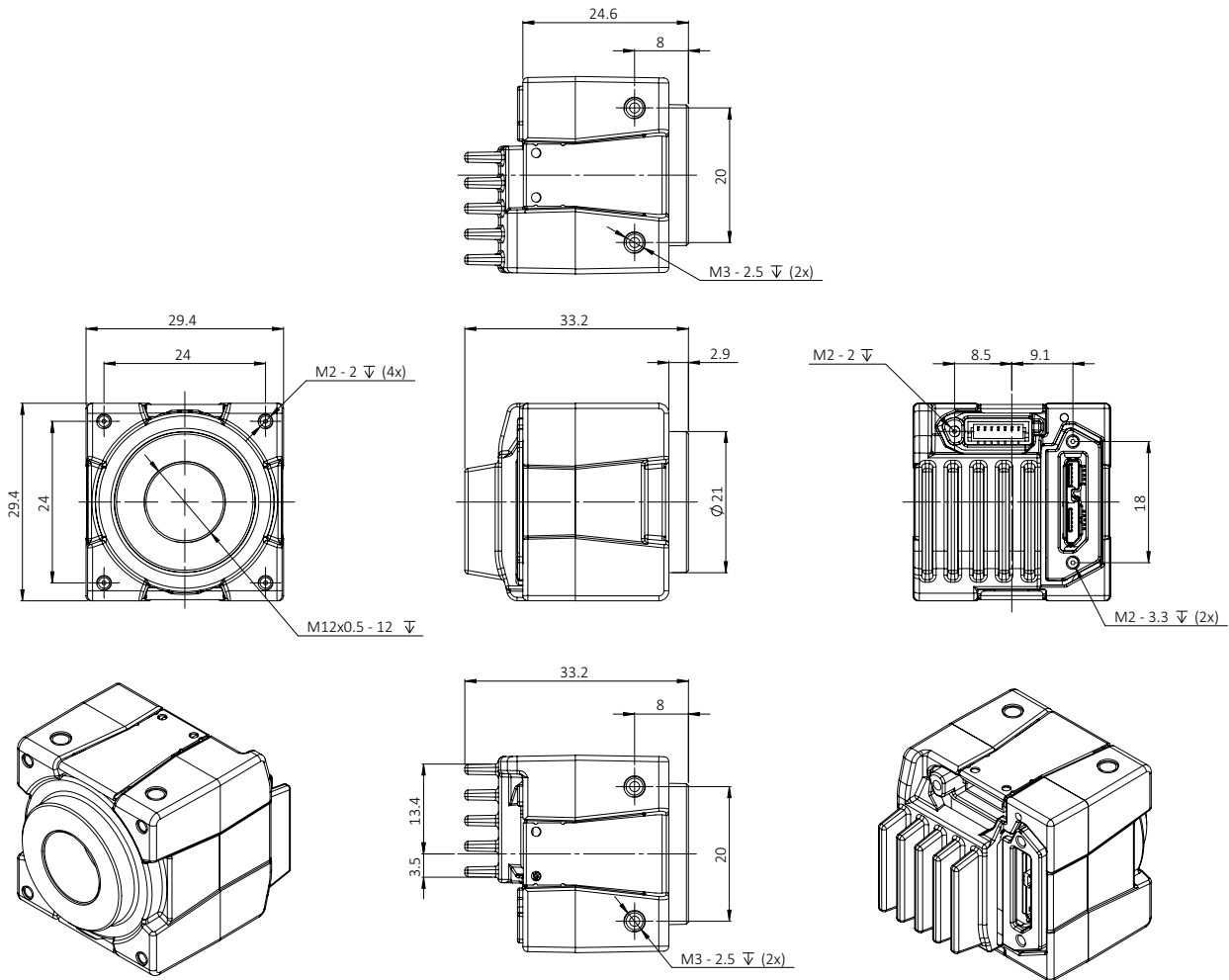

Figure 67: Closed Housing S-Mount 180° (standard Alvium) dimensions

## Closed Housing C-Mount 90° (standard Alvium)

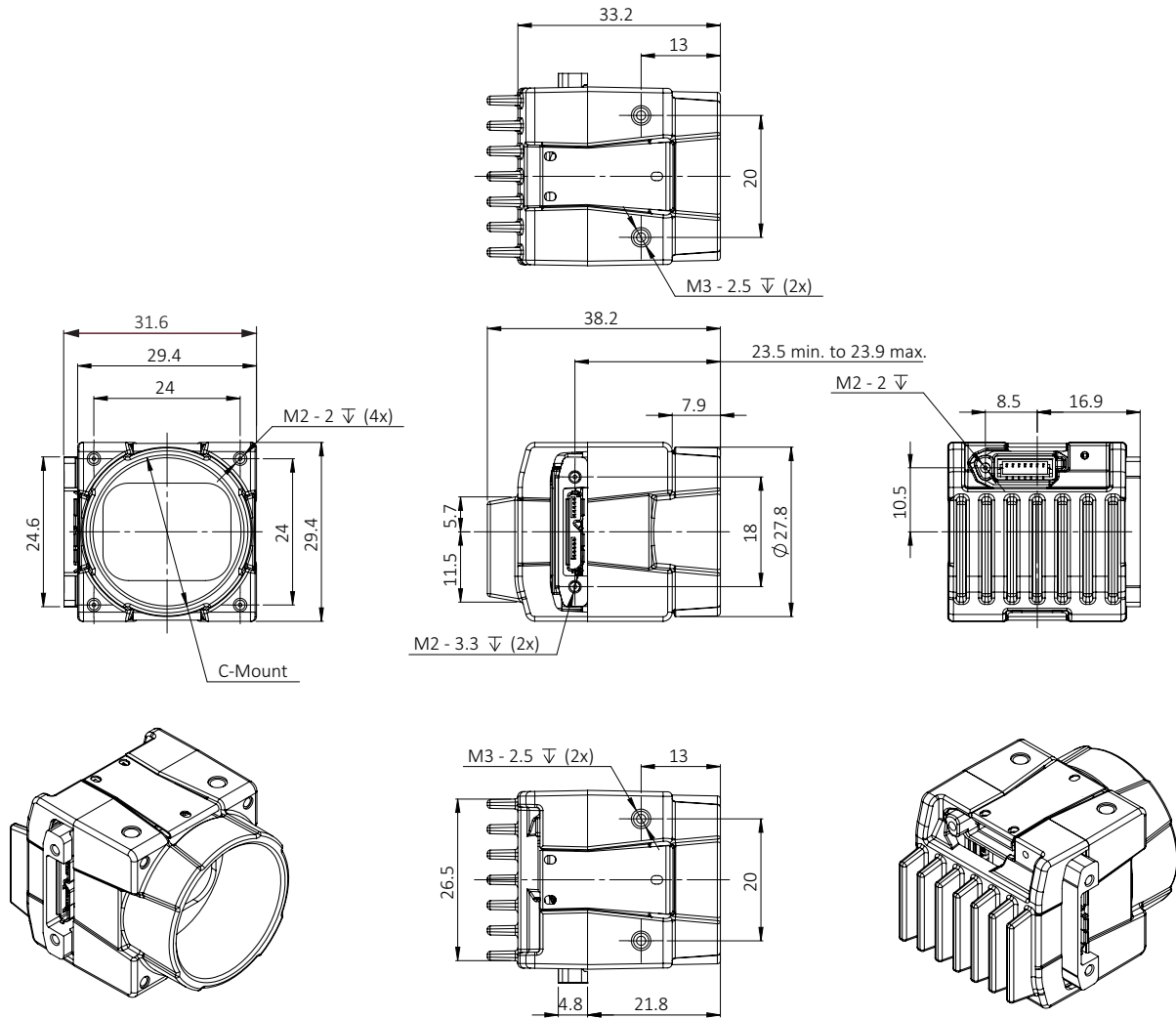

Figure 68: Closed Housing C-Mount 90° (standard Alvium) dimensions

## Closed Housing CS-Mount 90° (standard Alvium)

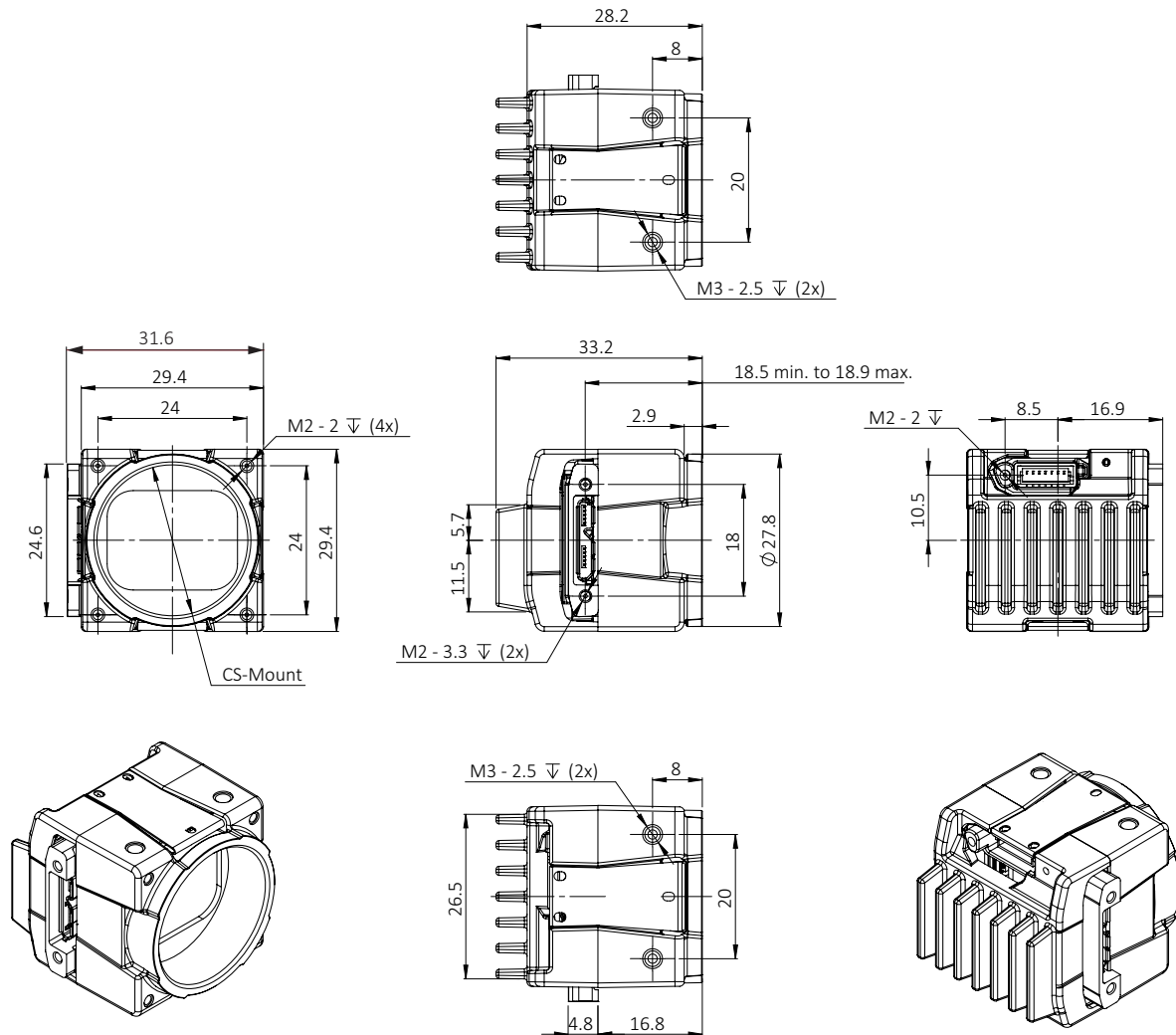

Figure 69: Closed Housing CS-Mount 90° (standard Alvium) dimensions

## Closed Housing S-Mount 90° (standard Alvium)

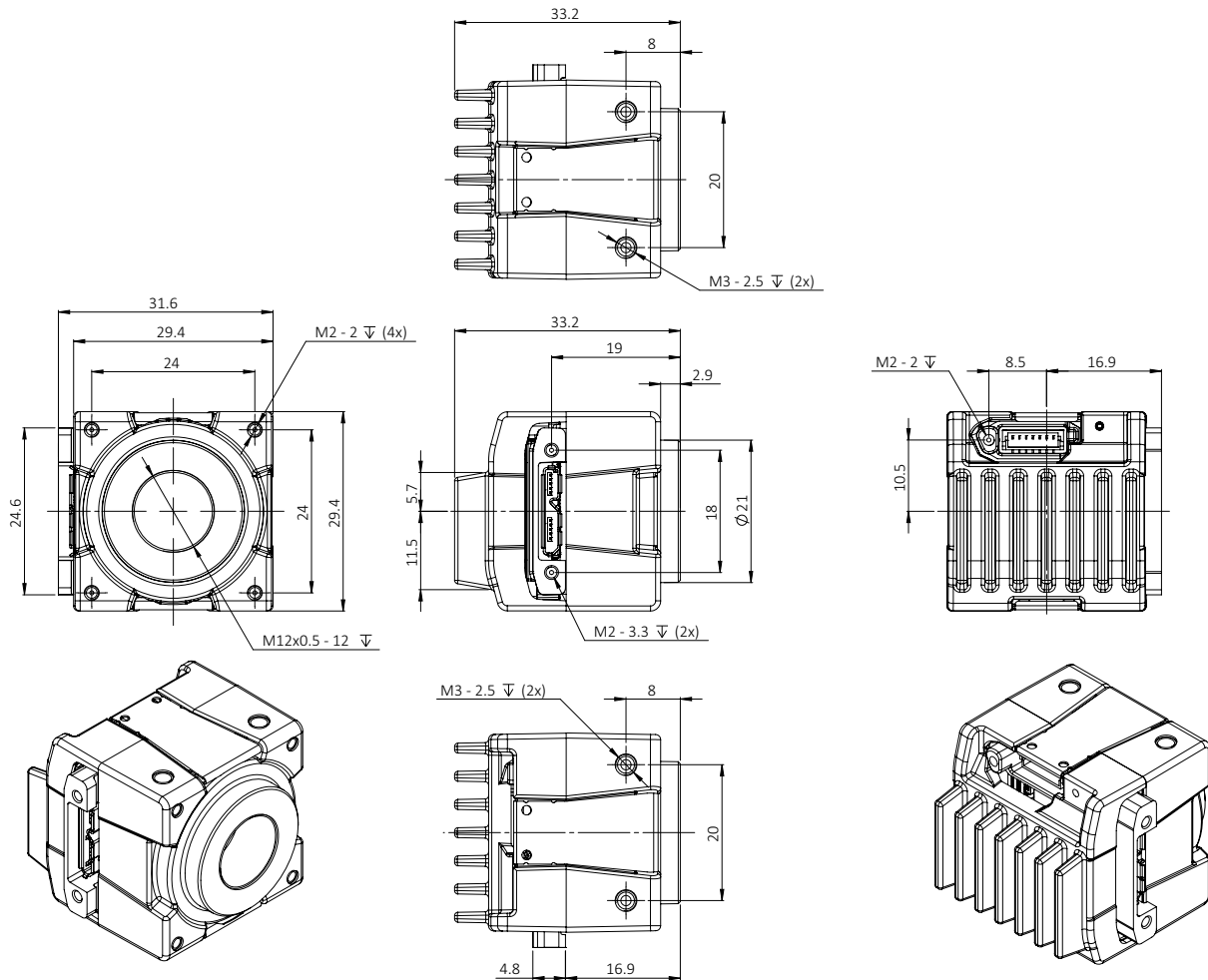

Figure 70: Closed Housing S-Mount 90° (standard Alvium) dimensions

# Alvium Flex: Dimensions and mass

## Bare board

Feature	Specification
Dimensions (L × W × H)	[Model specific] × 26 mm × 26 mm
Mass	10 g

Table 101: Alvium Flex - bare board dimensions and mass

## Open housing

Open housing	C-Mount	CS-Mount	S-Mount
Flange focal distance, optical	17.526 mm	12.526 mm	12.63 mm
Thread	1"-32tpi UNS-2B	1"-32tpi UNS-2B	M12 × 0.5 mm
Maximum protrusion <sup>1</sup>	13.6 mm	8.6 mm	11.0 mm
Body dimensions (L × W × H) in [mm]	25 × 29 × 29	20 × 29 × 29	20 × 29 × 29
Mass	40 g		

<sup>1</sup> For details, see [Maximum protrusion for front mounts](#).

Table 102: Alvium Flex - open housing dimensions and mass

# Alvium Flex: Technical drawings

Alvium USB Flex cameras are available with the following housing options:

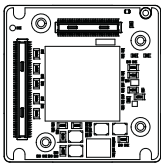
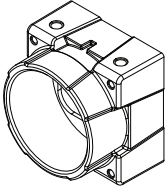
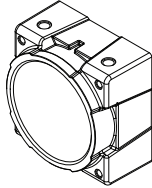
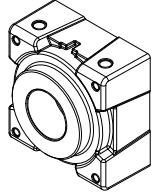
				
<b>Option</b>	Bare Board	Open Housing C-Mount	Open Housing CS-Mount	Open Housing S-Mount
<b>Page</b>	<a href="#">223</a>	<a href="#">224</a>	<a href="#">225</a>	<a href="#">226</a>

## Bare Board (Alvium Flex)

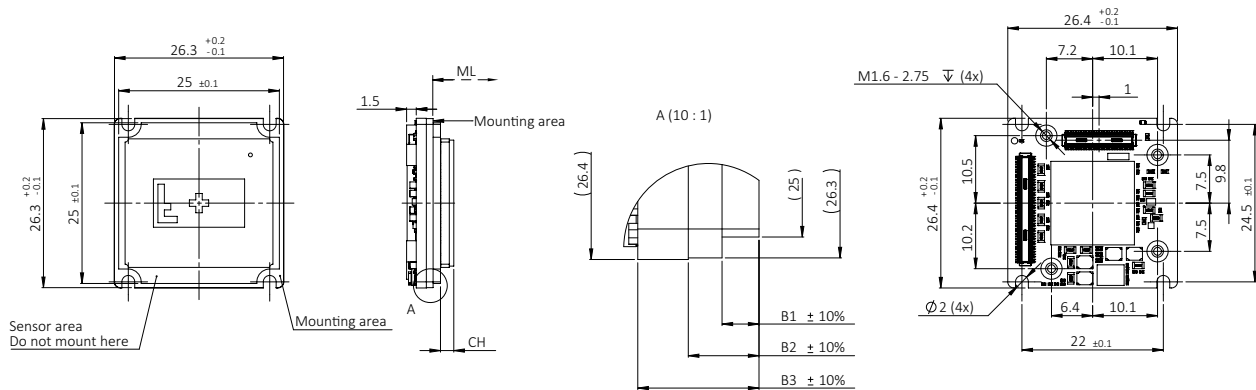

Figure 71: Bare Board (Alvium Flex) dimensions

Dimensions that are common between different models are shown in [Figure 71](#). Model specific dimensions are listed in [Table 100](#). **Mechanical length (ML)** defines the mechanical distance from the mounting area to the lens mount front flange, without optical filter. **Components height (CH)** relates to the electronic components with maximum height, in some cases the sensor.

## Open Housing C-Mount (Alvium Flex)

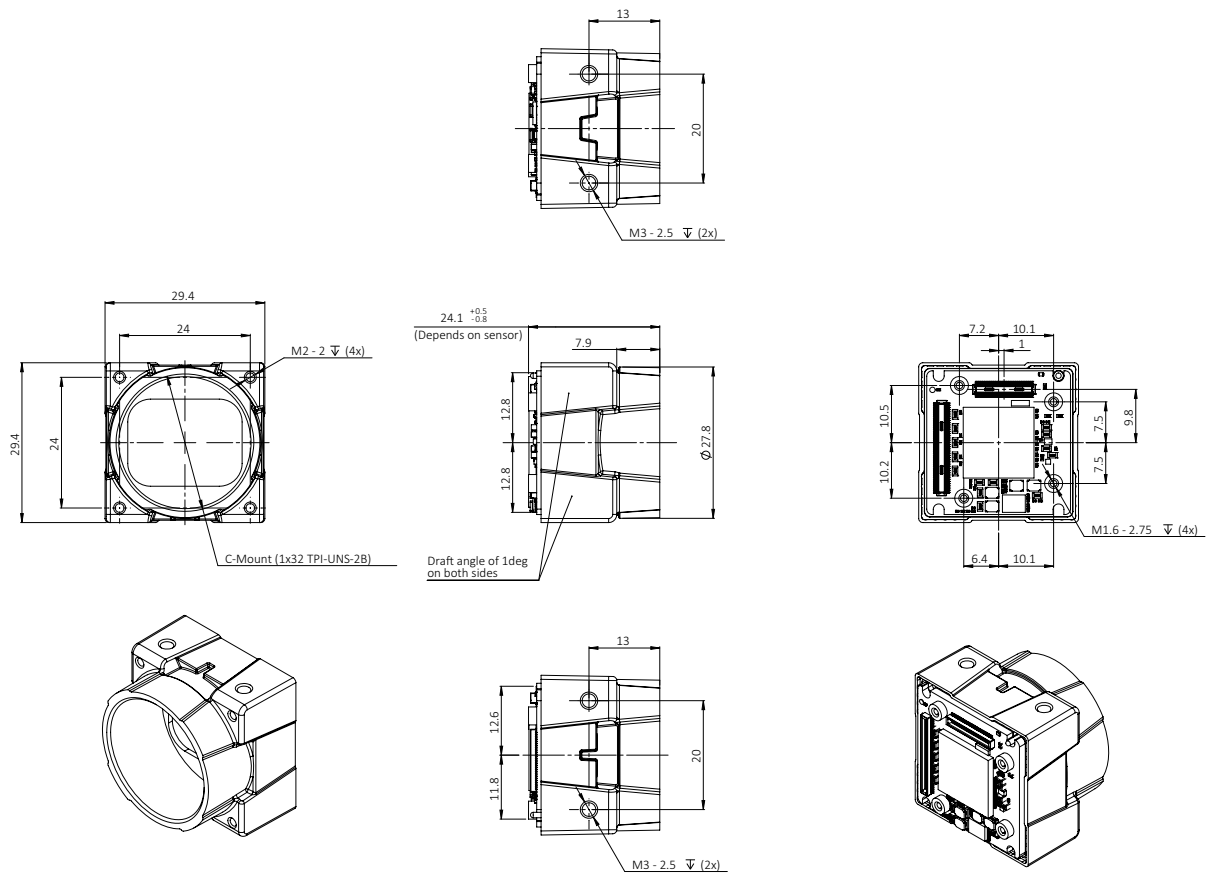

Figure 72: Open Housing C-Mount (Alvium Flex) dimensions



## Open Housing CS-Mount (Alvium Flex)

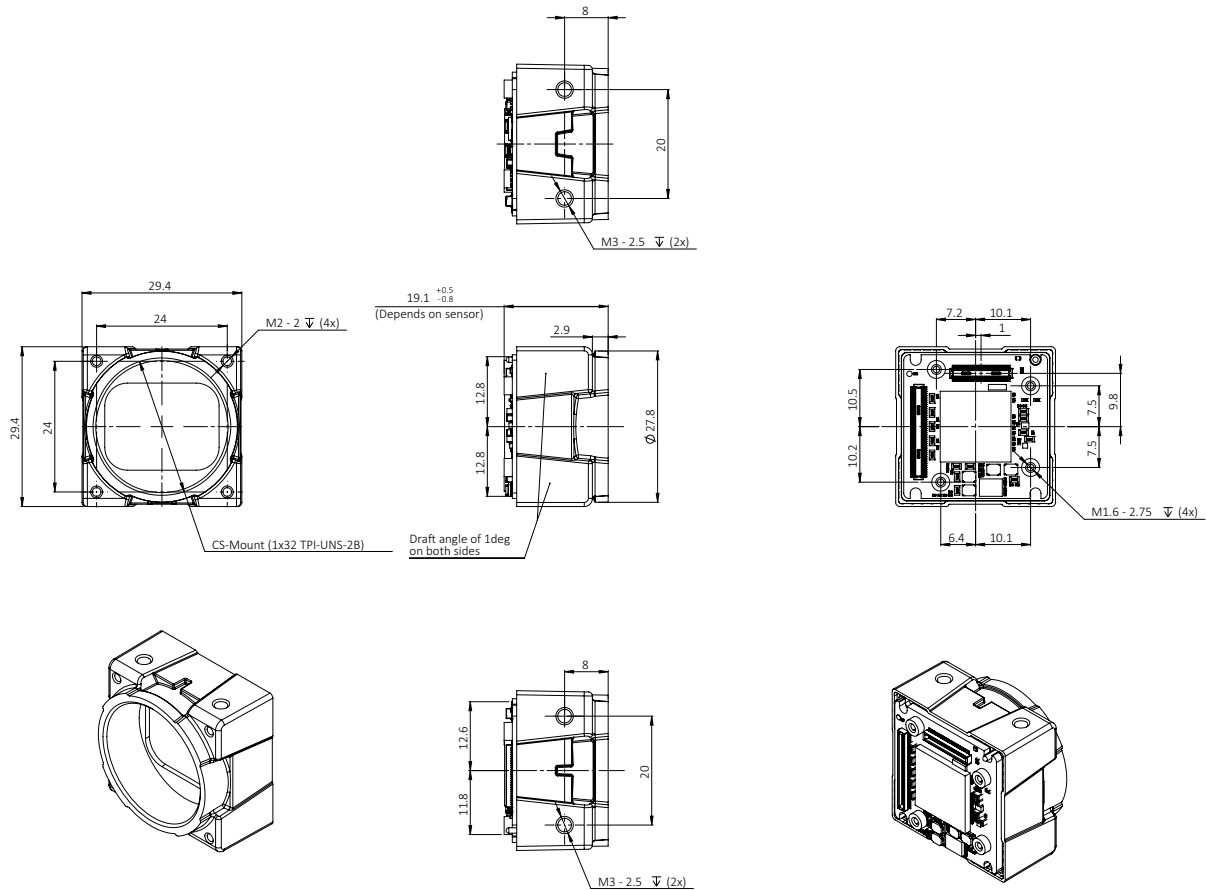

Figure 73: Open Housing CS-Mount (Alvium Flex) dimensions

## Open Housing S-Mount (Alvium Flex)

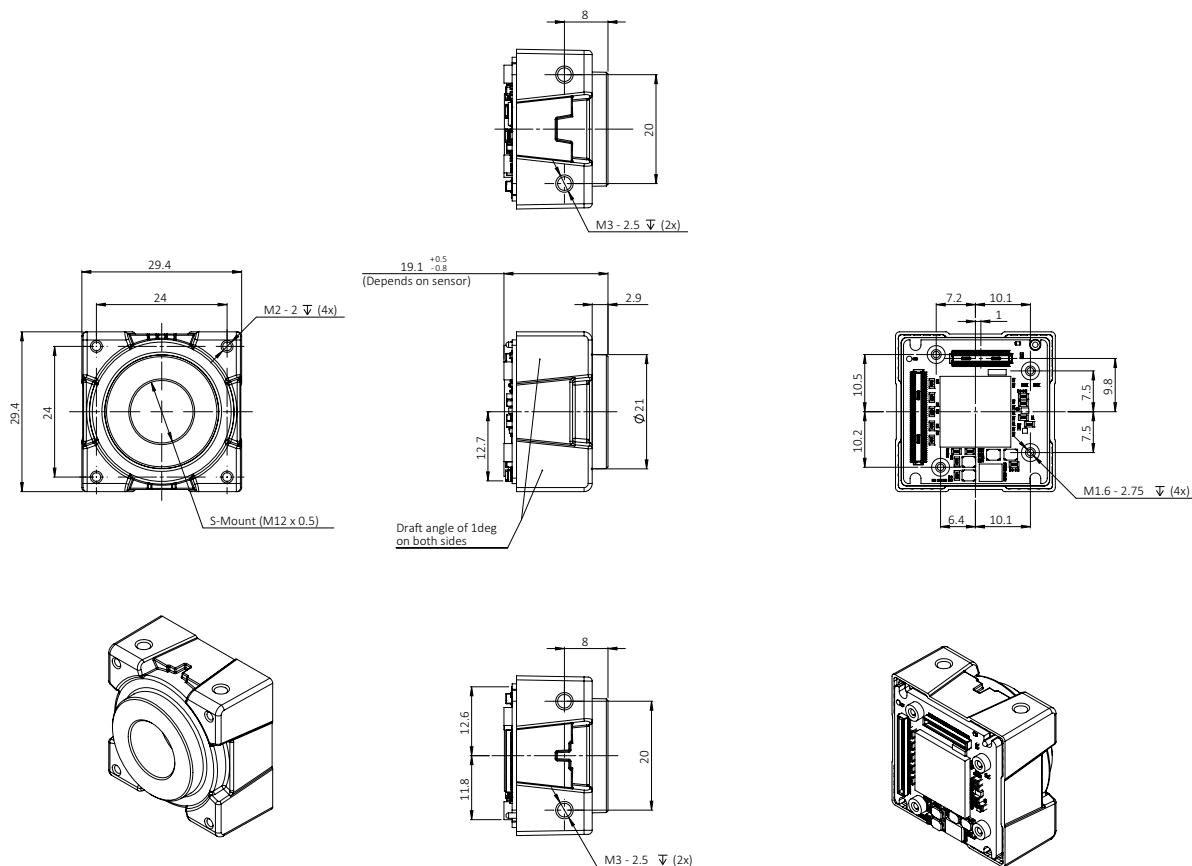

Figure 74: Open Housing S-Mount (Alvium Flex) dimensions

# Alvium Frame: Dimensions and mass

Frame cameras	Frame 180°	Frame 90°
Flange focal distance, optical	3.576 mm	
Front hole diameter	24.5 mm	
Maximum protrusion	1.5 mm	
Body dimensions (L × W × H)	16.3 mm × 29 mm × 29 mm	16.3 mm × 31.4 mm × 29 mm
Mass	20 g	25 g

Table 103: Housing dimensions and mass (Alvium Frame)

# Alvium Frame: Technical drawings

## Alvium Frame 180°

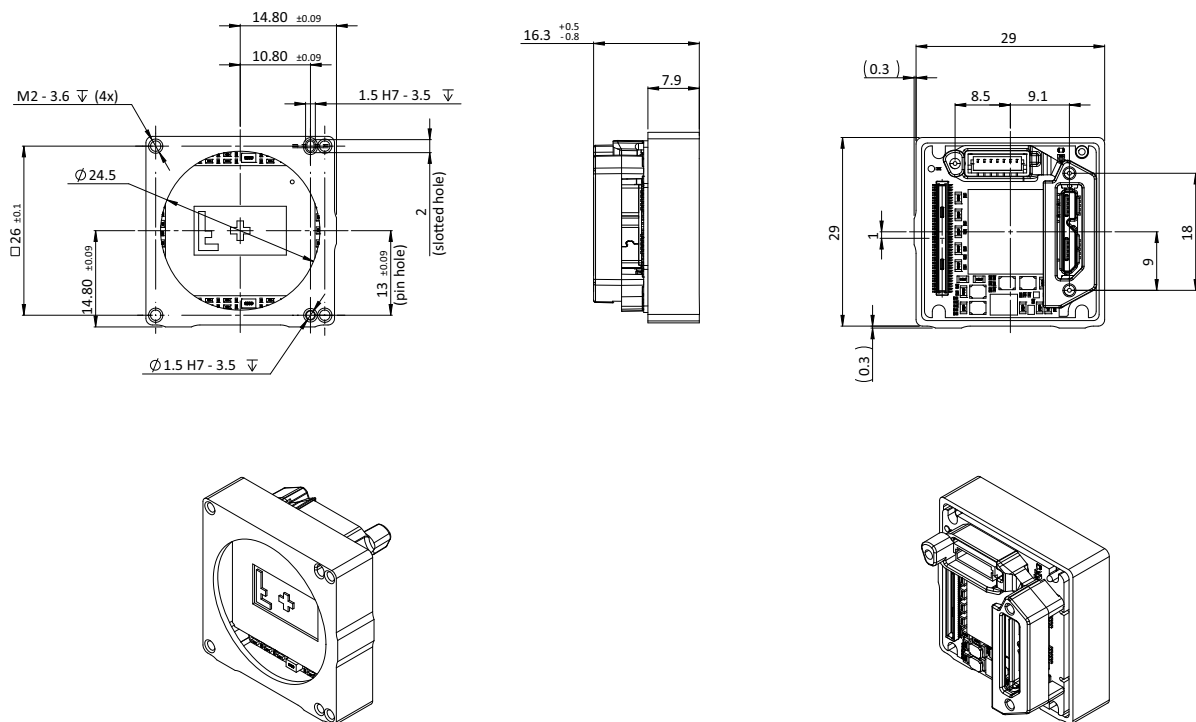

Figure 75: Alvium Frame 180° dimensions

## Alvium Frame 90°

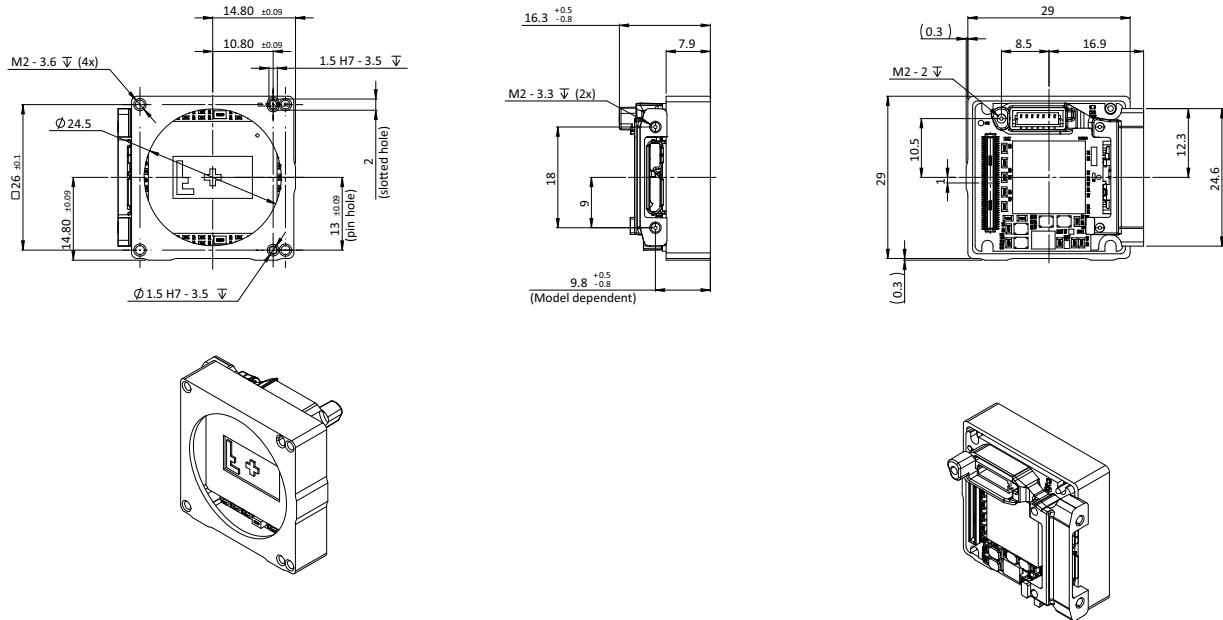

Figure 76: Alvium Frame 90° dimensions

## Alvium Frame Flex: Dimensions and mass

Frame cameras	Frame Flex
Flange focal distance, optical	3.576 mm
Front hole diameter	24.5 mm
Maximum protrusion <sup>1</sup>	1.5 mm
Body dimensions (L × W × H)	10.1 mm × 29 mm × 29 mm
Mass	15 g

Table 104: Housing dimensions and mass (Alvium Frame Flex)

# Alvium Frame Flex: Technical drawings

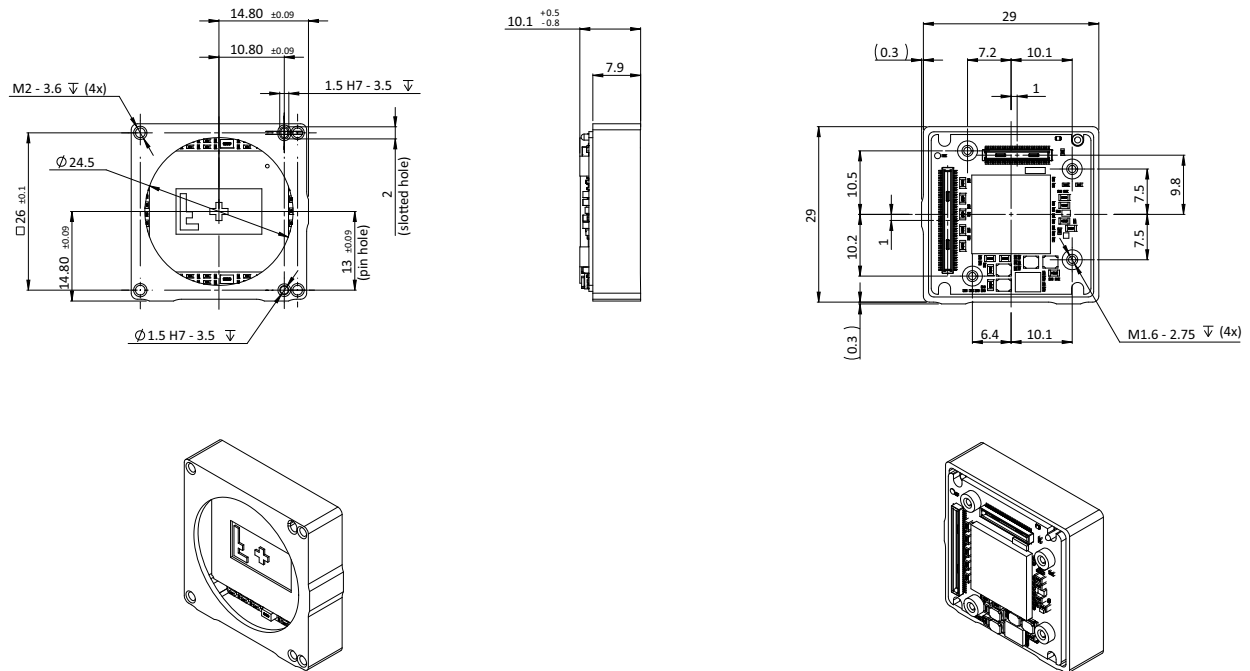

Figure 77: Alvium Frame Flex dimension

# Maximum protrusion for front mounts



## No need to readjust lens mounts

Alvium USB camera mounts are adjusted with high precision during manufacturing. Construction ensures permanent accuracy without need to readjust.

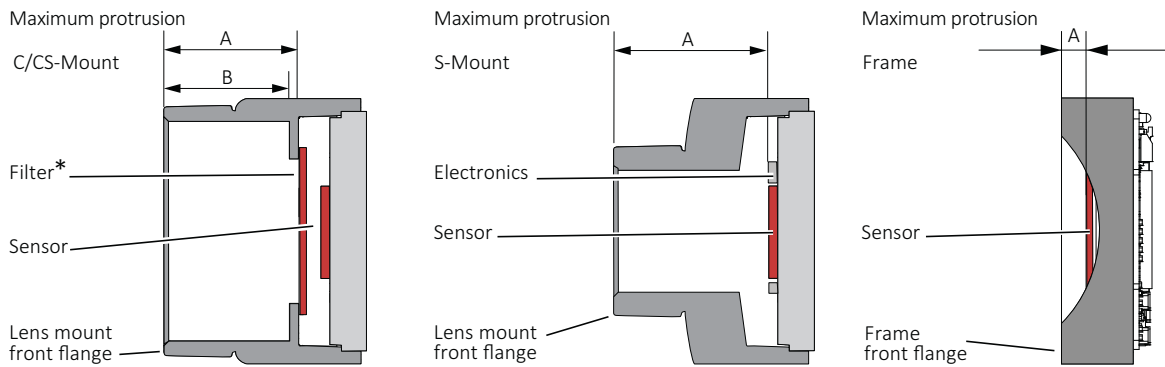

\*Only color models are equipped with an IR cut filter

Figure 78: Maximum protrusion CS-Mount and C-Mount, S-Mount, Frame

Figure 78 shows schematics for maximum protrusion of objects (typically lenses), Table 105 shows values for maximum protrusion.



### NOTICE

#### Damage to sensor, optics, or electronics by unsuitable lenses or objects

The sensor, filter, lens, or camera electronics can be damaged if an object (typically a lens) exceeding maximum protrusion is mounted to the camera.

- Use lenses with less than the allowed maximum protrusion, see [Table 105](#).
- Mount objects with less than the allowed maximum protrusion, see [Table 105](#).
- See [Mounting the lens](#) on page 265.
- For S-Mount lenses, see [Mounting and focusing S-Mount lenses](#) on page 266.

Mount	Maximum protrusion
C-Mount	13.6 mm
CS-Mount	8.6 mm
S-Mount	11.0 mm
Frame	1.5 mm

Table 105: Alvium USB cameras maximum protrusion

## IR cut filter

Table 106 shows which Alvium models are equipped with an IR cut filter. The filter is permanently installed and cannot be removed.

Color or monochrome model	C-Mount	CS-Mount	S-Mount	Bare Board	Frame
Color	Type Hoya C-5000 IR cut filter			No filter	
Monochrome and VSWIR	No filter				

Table 106: Optical filter availability

Cameras **without** IR cut filter have a higher sensitivity for low-light imaging. Moreover, spectral sensitivity is increased.

Cameras **with** IR cut filter are more accurate in reproduction of color, contrast, and sharpness, as the filter absorbs near-IR wavelengths. See Figure 79 for filter transmission.



### Spectral transmission values

The following curve shows typical transmission for type Hoya C-5000 IR cut filter. Values may vary slightly by filter lot.

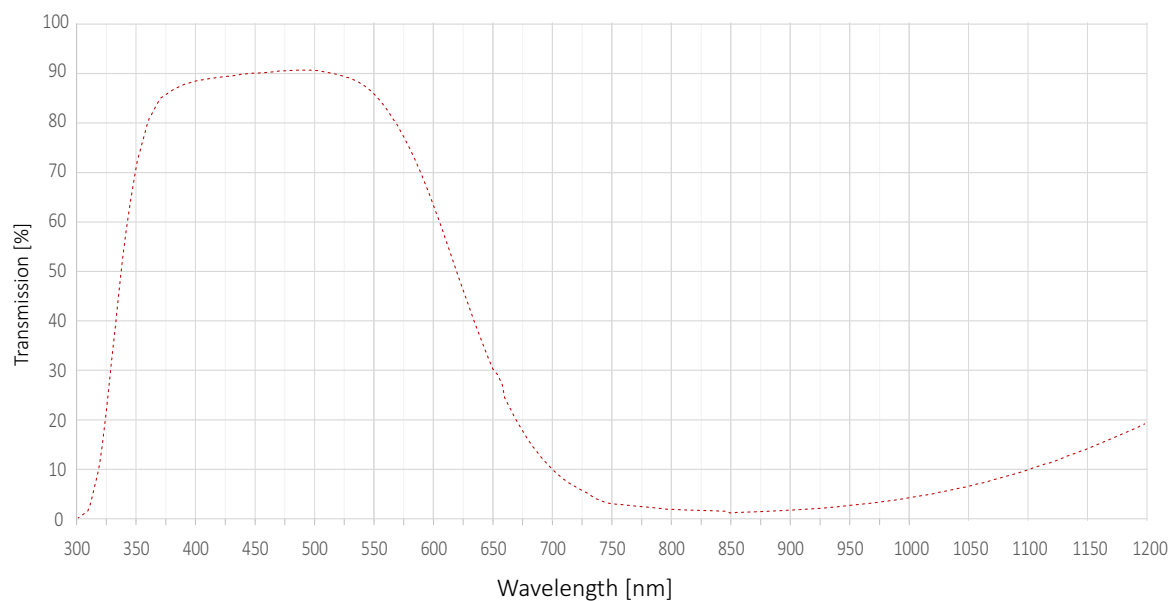

Figure 79: Type Hoya C-5000 IR cut filter spectral transmission (exemplary curve)



### S-Mount lenses with IR cut design

For improved image quality, we recommend using S-Mount lenses that are IR- optimized or that have IR cut coating. See the S-Mount Lenses User Guide at [www.alliedvision.com/fileadmin/content/documents/products/accessories/lenses/Allied\\_Vision/Data Sheet/S-Mount-Lenses\\_User-Guide.pdf](http://www.alliedvision.com/fileadmin/content/documents/products/accessories/lenses/Allied_Vision/Data_Sheet/S-Mount-Lenses_User-Guide.pdf).

# Sensor position accuracy



## Sensor alignment for bare board cameras

The sensors in Alvim bare board cameras are not aligned to a lens mount. You must align these cameras into housings individually, which can be difficult and expensive. As a possible solution, Alvim Frame cameras provide alignment areas and holes to fit into individual housings, see [Alvim Frame- use your own optical mount](#) on page 19.

## Housed standard and Flex cameras: Sensor shift and rotation

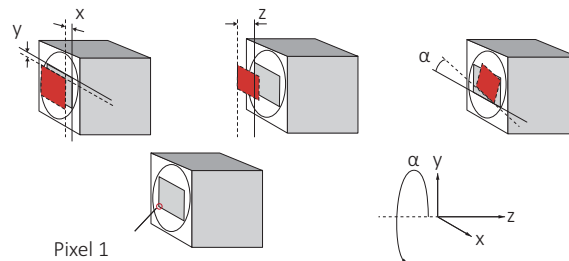

**Gray rectangle:** Reference sensor position    **Red rectangle:** Current position  
**Straight line:** Reference edge    **Dotted line:** Current reference edge

The orientation of the z-axis deviates from scientific conventions to define tolerances of the flange focal distance.

Figure 80: Sensor shift and rotation

The following table defines the manufacturing accuracy for sensor positioning with housed standard and Flex cameras.

Criteria	Subject	Properties
Alignment method		Optical alignment of the photosensitive sensor area into the camera front module (lens mount front flange)
Reference Points	Sensor	Center of the pixel area (photo sensitive cells)
	Camera	Center of the lens mount
Accuracy	x/y-axis <sup>1</sup>	±150 µm (sensor shift)
	z	0 to -100 µm (optical back focal length)
	α <sup>1</sup>	±0.5 deg (sensor rotation as the deviation from the parallel to the camera bottom)

<sup>1</sup> We cannot measure or guarantee these values for S-Mount hardware options that are manufactured on customer request for: Alvim 1800 U-052, -203, -234, -235, -291, -320 VSWIR, -507, -507 Pol, -508, -508 Pol, -511, -530 VSWIR, -811, -812 UV, -895, -1236, -1242, -1620, -2040, -2050, -2460.

Table 107: Alvim USB cameras, criteria of sensor position accuracy



**Values for Alvium Frame cameras**

For sensor shift and rotation with Alvium Frame cameras, see [Housed Alvium Frame: Sensor shift and rotation](#) on page 233. For sensor tilt, see [Housed Alvium USB cameras: Sensor tilt](#) on page 233.

## Housed Alvium Frame: Sensor shift and rotation

The following table defines the manufacturing accuracy for sensor positioning with housed Alvium Frame cameras. For sensor tilt, see [Housed Alvium USB cameras: Sensor tilt](#) on page 233.

Criteria	Subject	Properties
Alignment method		Optical alignment of the photosensitive sensor area into the camera front module (lens mount front flange)
Reference Points	Sensor	Center of the pixel area (photo sensitive cells)
	Camera	Center of the lens mount
Accuracy	x/y-axis	$\pm 90 \mu\text{m}$ (sensor shift)
	z	0 to $-50 \mu\text{m}$ (optical back focal length)
	$\alpha^1$	$\pm 0.5 \text{ deg}$ (sensor rotation as the deviation from the parallel to the camera bottom)

Table 108: Alvium USB Frame cameras, sensor shift and rotation

## Housed Alvium USB cameras: Sensor tilt

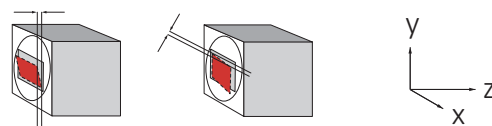

**Gray rectangle:** Reference sensor position    **Red rectangle:** Current position

Figure 81: Sensor tilt

The following table defines sensor tilt as the variance between highest and lowest pixel of a sensor along the z-axis, measured in micrometers for housed Alvium USB cameras.

Alvium model	Pixel size	Maximum tilt
Alvium 1800 U-030 VSWIR	$5 \mu\text{m} \times 5 \mu\text{m}$	$50 \mu\text{m}$
Alvium 1800 U-040m/c	$6.9 \mu\text{m} \times 6.9 \mu\text{m}$	$95 \mu\text{m}$

Table 109: Sensor tilt (sheet 1 of 2)

Alvium 1800 U-050m/c	4.8 $\mu\text{m}$ $\times$ 4.8 $\mu\text{m}$	47 $\mu\text{m}$
Alvium 1800 U-052m/c	9.0 $\mu\text{m}$ $\times$ 9.0 $\mu\text{m}$	36 $\mu\text{m}$
Alvium 1800 U-120m/c	3.75 $\mu\text{m}$ $\times$ 3.75 $\mu\text{m}$	29 $\mu\text{m}$
Alvium 1800 U-130 VSWIR	5 $\mu\text{m}$ $\times$ 5 $\mu\text{m}$	50 $\mu\text{m}$
Alvium 1800 U-131m/c	5.3 $\mu\text{m}$ $\times$ 5.3 $\mu\text{m}$	57 $\mu\text{m}$
Alvium 1800 U-158m/c	3.45 $\mu\text{m}$ $\times$ 3.45 $\mu\text{m}$	24 $\mu\text{m}$
Alvium 1800 U-192m/c	4.5 $\mu\text{m}$ $\times$ 4.5 $\mu\text{m}$	41 $\mu\text{m}$
Alvium 1800 U-203m/c	4.5 $\mu\text{m}$ $\times$ 4.5 $\mu\text{m}$	41 $\mu\text{m}$
Alvium 1800 U-234m/c	5.86 $\mu\text{m}$ $\times$ 5.86 $\mu\text{m}$	69 $\mu\text{m}$
Alvium 1800 U-235m/c	5.86 $\mu\text{m}$ $\times$ 5.86 $\mu\text{m}$	69 $\mu\text{m}$
Alvium 1800 U-240m/c	3.45 $\mu\text{m}$ $\times$ 3.45 $\mu\text{m}$	24 $\mu\text{m}$
Alvium 1800 U-291m/c	4.5 $\mu\text{m}$ $\times$ 4.5 $\mu\text{m}$	18 $\mu\text{m}$
Alvium 1800 U-319m/c	3.45 $\mu\text{m}$ $\times$ 3.45 $\mu\text{m}$	24 $\mu\text{m}$
Alvium 1800 U-320 VSWIR	3.45 $\mu\text{m}$ $\times$ 3.45 $\mu\text{m}$	24 $\mu\text{m}$
Alvium 1800 U-500m/c	2.2 $\mu\text{m}$ $\times$ 2.2 $\mu\text{m}$	15 $\mu\text{m}$
Alvium 1800 U-501m/c NIR	2.2 $\mu\text{m}$ $\times$ 2.2 $\mu\text{m}$	15 $\mu\text{m}$
Alvium 1800 U-507m/c	3.45 $\mu\text{m}$ $\times$ 3.45 $\mu\text{m}$	24 $\mu\text{m}$
Alvium 1800 U-507m/c Pol	3.45 $\mu\text{m}$ $\times$ 3.45 $\mu\text{m}$	24 $\mu\text{m}$
Alvium 1800 U-508m/c	3.45 $\mu\text{m}$ $\times$ 3.45 $\mu\text{m}$	24 $\mu\text{m}$
Alvium 1800 U-508m/c Pol	3.45 $\mu\text{m}$ $\times$ 3.45 $\mu\text{m}$	24 $\mu\text{m}$
Alvium 1800 U-510m/c	2.74 $\mu\text{m}$ $\times$ 2.74 $\mu\text{m}$	18 $\mu\text{m}$
Alvium 1800 U-511m/c	2.74 $\mu\text{m}$ $\times$ 2.74 $\mu\text{m}$	18 $\mu\text{m}$
Alvium 1800 U-530 VSWIR	3.45 $\mu\text{m}$ $\times$ 3.45 $\mu\text{m}$	24 $\mu\text{m}$
Alvium 1800 U-811m/c	2.74 $\mu\text{m}$ $\times$ 2.74 $\mu\text{m}$	18 $\mu\text{m}$
Alvium 1800 U-812 UV	2.74 $\mu\text{m}$ $\times$ 2.74 $\mu\text{m}$	15 $\mu\text{m}$
Alvium 1800 U-895m/c	3.45 $\mu\text{m}$ $\times$ 3.45 $\mu\text{m}$	24 $\mu\text{m}$
Alvium 1800 U-1236m/c	3.45 $\mu\text{m}$ $\times$ 3.45 $\mu\text{m}$	24 $\mu\text{m}$
Alvium 1800 U-1240m/c	1.85 $\mu\text{m}$ $\times$ 1.85 $\mu\text{m}$	12 $\mu\text{m}$
Alvium 1800 U-1242m/c	2.74 $\mu\text{m}$ $\times$ 2.74 $\mu\text{m}$	18 $\mu\text{m}$
Alvium 1800 U-1620m/c	2.74 $\mu\text{m}$ $\times$ 2.74 $\mu\text{m}$	18 $\mu\text{m}$
Alvium 1800 U-2040m/c	2.74 $\mu\text{m}$ $\times$ 2.74 $\mu\text{m}$	18 $\mu\text{m}$
Alvium 1800 U-2050m/c	2.4 $\mu\text{m}$ $\times$ 2.4 $\mu\text{m}$	12 $\mu\text{m}$
Alvium 1800 U-2460m/c	2.74 $\mu\text{m}$ $\times$ 2.74 $\mu\text{m}$	18 $\mu\text{m}$

Table 109: Sensor tilt (sheet 2 of 2)

# User sets

## Supported features

UserSet features enable to store individual settings on Alvium USB cameras. These user sets can be loaded by default, without needing to set values by software after every restart of the camera. Or they can be used to switch between different settings, for example, to adjust from daylight to artificial light.

User sets on Alvium USB cameras support all features except for:

- Selectors
- Command features
- Read-only features
- Features that do not apply to the corresponding interface, such as CSI-2 related features on a USB camera
- Features in the LUTControl1 category.

## Trigger features and UserSetDefault

Trigger features are reset to default values when the default user set is loaded.

- Column **UserSetLoad** displays how user values are affected when the command for **UserSetLoad** is executed.
- Column **DeviceReset** displays how user values are affected when the command for **DeviceReset** is executed.

Feature	Default value	UserSetDefault	DeviceReset
TriggerActivation	<i>RisingEdge</i>	Default value	Default value
TriggerMode	<i>Off</i>	Default value	Default value
TriggerSelector	<i>AcquisitionStart</i>	User value	Default value
TriggerSoftware	[Command]	Not applicable	Not applicable
TriggerSource	<i>Software</i>	Default value	Default value

Table 110: Trigger features being reset

## Camera feature availability

Alvium 1800 U cameras support a number of standard and extended features. The following tables compare the availability of selected features by model.



### Feature description and firmware downloads

Alvium Features Reference: [www.alliedvision.com/en/support/technical-documentation/alvium-usb-documentation](http://www.alliedvision.com/en/support/technical-documentation/alvium-usb-documentation)

Firmware downloads: [www.alliedvision.com/en/support/firmware-downloads](http://www.alliedvision.com/en/support/firmware-downloads)

Image control	Monochrome models	Color models	Supported models
Adaptive noise correction	✓	✓	All, <b>except</b> for: 1800 U-507 Pol, -508 Pol
Auto exposure	✓	✓	All
Auto gain	✓	✓	All
Auto white balance	-	✓	All, <b>except</b> for: 1800 U-507 Pol, -508 Pol
Color transformation (including hue, saturation)	-	✓	
Contrast	✓	✓	
Custom convolution	✓	✓	
De-Bayering up to 5x5	-	✓	
<b>Digital</b> binning	✓	✓	
DPC (defect pixel correction)	✓	✓	
FPNC (fixed pattern noise correction)	✓	✓	All, <b>except</b> for: 1800 U-030 VSWIR, -052, -130 VSWIR, -203, -234, -235, -291, -320 VSWIR, -507 Pol, -508 Pol, -530 VSWIR, -895, -2050
Gamma	✓	✓	All
Lens shading correction	✓	✓	All
Look up table (LUT)	✓	✓	All, <b>except</b> for: 1800 U-507 Pol, -508 Pol

Table 111: Image control features by Alvium 1800 U model (sheet 1 of 2)

Image control	Monochrome models	Color models	Supported models
<b>Multiple</b> ROI (regions of interest)	✓	✓	All, <b>except</b> for: 1800 U-050, -120, -131, -192, -500, -501 NIR, -1240, -2050
Reverse X/Y	✓	✓	All
<b>Sensor</b> binning	✓	-	1800 U-158m, -203m, -240m, -291m, -500m, -501m NIR, -508m, -510m, -511m, -811m, -812 UV, -1242m, -1620m, -2040m, -2460m
Sharpness/Blur	✓	✓	All, <b>except</b> for: 1800 U-507 Pol, -508 Pol
<b>Single</b> ROI (region of interest)	✓	✓	All

Table 111: Image control features by Alvium 1800 U model (sheet 2 of 2)

Camera control	Monochrome models	Color models	Supported models
Acquisition frame rate	✓	✓	All
Bandwidth control (DeviceLinkThroughputLimit)	✓	✓	All
Counters and timers	✓	✓	All
Firmware update in the field	✓	✓	All
Image chunk data	✓	✓	All, <b>except</b> for: 1800 U-050
I/O and trigger control	✓	✓	All
Sensor ADC readout modes (SensorBitDepth)	✓	✓	1800 U-030 VSWIR, -040, -052, -130 VSWIR, -158, -203, -234, -235, -240, -291, -320 VSWIR, -508, -508 Pol, -530 VSWIR

Table 112: Camera control features by Alvium 1800 U model (sheet 1 of 2)

Camera control	Monochrome models	Color models	Supported models
Sequencer	✓	✓	All, <b>except</b> for: 1800 U-120, -500, -501 NIR, 1240, 2050
Serial I/Os	✓	✓	All
Temperature monitoring (mainboard)	✓	✓	All
U3 power saving mode	✓	✓	All
User sets	✓	✓	All

*Table 112: Camera control features by Alvium 1800 U model (sheet 2 of 2)*

# Lenses: Focal length vs. field of view



This chapter includes:

About this chapter .....	240
Optical vignetting with certain lenses .....	240
About S-Mount lenses .....	241
Focal length vs. field of view .....	241

## About this chapter

This section presents tables that list selected fields of view (FOV) depending on sensor size, distance, and focal length of the lens.

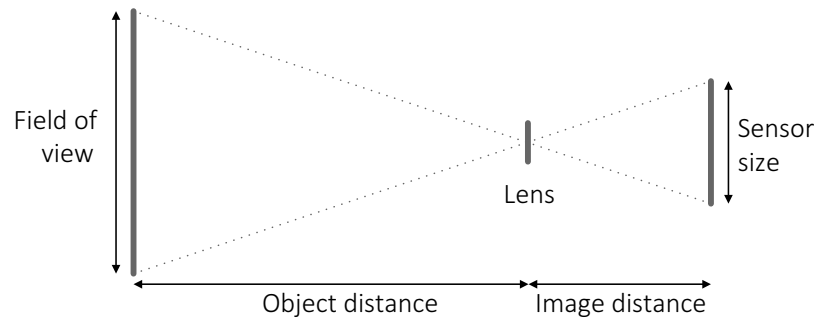

Figure 82: Parameters used in tables for focal length versus FOV



### Allied Vision S-Mount lenses

For technical data of Allied Vision S-Mount lenses with dedicated operating instructions, see the S-Mount Lenses User Guide at

[www.alliedvision.com/fileadmin/content/documents/products/accessories/lenses/Allied\\_Vision/Data\\_sheet/S-Mount-Lenses\\_User-Guide.pdf](http://www.alliedvision.com/fileadmin/content/documents/products/accessories/lenses/Allied_Vision/Data_sheet/S-Mount-Lenses_User-Guide.pdf).

## Parameters in tables

The distance to the object is measured from the first principal the plane of the lens to the object. For some lenses, manufacturers do not define the principal plane position. Production spread causes tolerances for all values, including actual focal lengths. Calculations apply for image reproduction without distortion. Therefore, values do not apply for fisheye lenses.

Please ask your Allied Vision Sales representative in case you need more information.

## Optical vignetting with certain lenses

Lenses with short focal lengths may show optical vignetting at the edges of the image. Microlenses on the sensor pixels can increase the effect.

For demanding applications, we suggest testing camera and lens to find a suitable setup. If you have questions, please contact your Allied Vision Sales representative.



## About S-Mount lenses

Alvium S-Mount models have no filter. For typical applications, we recommend using S-Mount lenses with an integrated IR cut filter for a better image quality.

Read [Mounting and focusing S-Mount lenses](#) on page 266 to avoid damage when using S-Mount lenses.

## Focal length vs. field of view

### Alvium 1800 U-030 VSWIR

Values for 1800 U-030 VSWIR cameras with Type 1/4 (4.1 mm diagonal) sensors:

Focal length [mm]	Field of view (H × V [mm])	
	Object distance = 500 mm	Object distance = 1000 mm
4	407 × 322	817 × 647
5	775 × 773	1557 × 1553
6	644 × 642	1296 × 1293
8	481 × 480	970 × 968
12	318 × 317	644 × 642
16	237 × 236	481 × 480
25	149 × 148	305 × 304
35	104 × 104	216 × 215
50	70 × 70	149 × 148

Table 113: Focal length versus field of view for Alvium 1800 U-030 VSWIR

## Alvium 1800 U-040m/c

Values for 1800 U-040m/c cameras with Type 1/2.9 (6.3 mm diagonal) sensors:

Focal length [mm]	Field of view (H × V [mm])	
	Object distance = 500 mm	Object distance = 1000 mm
2.8	892 × 667	1789 × 1337
3.6	693 × 518	1390 × 1039
4.8	518 × 387	1041 × 778
6	414 × 309	832 × 622
8	309 × 231	623 × 465
12	204 × 153	414 × 309
16	152 × 114	309 × 231
25	95 × 71	196 × 146

Table 114: Focal length versus field of view for Alvium 1800 U-040m/c

## Alvium 1800 U-050m/c

Values for 1800 U-050m/c cameras with Type 1/3.6 (4.9 mm diagonal) sensors:

Focal length [mm]	Field of view (H × V [mm])	
	Object distance = 500 mm	Object distance = 1000 mm
2.8	689 × 517	1381 × 1036
3.6	535 × 401	1073 × 805
4.8	400 × 300	804 × 603
6	319 × 239	643 × 482
8	239 × 179	481 × 361
12	158 × 118	319 × 239
16	117 × 88	239 × 179
25	74 × 55	151 × 113

Table 115: Focal length versus field of view for Alvium 1800 U-050m/c

## Alvium 1800 U-052m/c

Values for 1800 U-052m/c cameras with Type 1/1.7 (9.2 mm diagonal) sensors:

Focal length [mm]	Field of view (H × V [mm])	
	Object distance = 500 mm	Object distance = 1000 mm
5	671 × 560	1348 × 1125
6	558 × 466	1122 × 937
8	417 × 348	840 × 701
12	275 × 230	558 × 466
16	205 × 171	417 × 348
25	129 × 107	264 × 221
35	90 × 75	187 × 156
50	61 × 51	129 × 107

Table 116: Focal length versus field of view for Alvium 1800 U-052m/c

## Alvium 1800 U-120m/c

Values for 1800 U-120m/c cameras with Type 1/3 (6.0 mm diagonal) sensors:

Focal length [mm]	Field of view (H × V [mm])	
	Object distance = 500 mm	Object distance = 1000 mm
2.8	852 × 639	1709 × 1282
3.6	662 × 496	1329 × 996
4.8	495 × 371	995 × 746
6	395 × 296	795 × 596
8	295 × 221	595 × 446
12	195 × 146	395 × 296
16	145 × 109	295 × 221
25	91 × 68	187 × 140

Table 117: Focal length versus field of view for Alvium 1800 U-120m/c

## Alvium 1800 U-130 VSWIR

Values for 1800 U-130 VSWIR cameras with Type 1/2 (8.2 mm diagonal) sensors:

Focal length [mm]	Field of view (H × V [mm])	
	Object distance = 500 mm	Object distance = 1000 mm
5	671 × 560	1348 × 1125
6	558 × 466	1122 × 937
8	417 × 348	840 × 701
12	275 × 230	558 × 466
16	205 × 171	417 × 348
25	129 × 107	264 × 221
35	90 × 75	187 × 156
50	61 × 51	129 × 107

Table 118: Focal length versus field of view for Alvium 1800 U-130 VSWIR

## Alvium 1800 U-131m/c

Values for 1800 U-131m/c cameras with Type 1/1.8 (8.7 mm diagonal) sensors:

Focal length [mm]	Field of view (H × V in [mm])	
	Object distance = 500 mm	Object distance = 1000 mm
4.8	700 × 560	1407 × 1125
6	559 × 447	1124 × 899
8	417 × 334	841 × 673
12	276 × 221	559 × 447
16	205 × 164	417 × 334
25	129 × 103	265 × 212
35	90 × 72	187 × 150
50	61 × 49	129 × 103

Table 119: Focal length versus field of view for Alvium 1800 U-131m/c

## Alvium 1800 U-158m/c

Values for 1800 U-158m/c cameras with Type 1/2.9 (6.3 mm diagonal) sensors:

Focal length [mm]	Field of view (H × V [mm])	
	Object distance = 500 mm	Object distance = 1000 mm
2.8	892 × 667	1789 × 1337
3.6	693 × 518	1390 × 1039
4.8	518 × 387	1041 × 778
6	414 × 309	832 × 622
8	309 × 231	623 × 465
12	204 × 153	414 × 309
16	152 × 114	309 × 231
25	95 × 71	196 × 146

Table 120: Focal length versus field of view for Alvium 1800 U-158m/c

## Alvium 1800 U-192m/c

Values for 1800 U-192m/c cameras with Type 1/1.8 (9.0 mm diagonal) sensors:

Focal length [mm]	Field of view (H × V in [mm])	
	Object distance = 500 mm	Object distance = 1000 mm
4.8	743 × 557	1493 × 1120
6	593 × 445	1193 × 895
8	443 × 332	893 × 670
12	293 × 220	593 × 445
16	218 × 163	443 × 332
25	137 × 103	281 × 211
35	96 × 72	199 × 149
50	65 × 49	137 × 103

Table 121: Focal length versus field of view for Alvium 1800 U-192m/c

## Alvium 1800 U-203m/c

Values for 1800 U-203m/c cameras with Type 1/1.7 (9.2 mm diagonal) sensors:

Focal length [mm]	Field of view (H × V [mm])	
	Object distance = 500 mm	Object distance = 1000 mm
5	727 × 556	1461 × 1118
6	605 × 462	1217 × 930
8	452 × 345	911 × 696
12	299 × 228	605 × 462
16	222 × 170	452 × 345
25	140 × 107	286 × 219
35	98 × 75	202 × 155
50	66 × 51	140 × 107

Table 122: Focal length versus field of view for Alvium 1800 U-203m/c

## Alvium 1800 U-234m/c, -235m/c

Values for 1800 U-234m/c and -235m/c cameras with Type 1/1.2 (13.4 mm diagonal) sensors:

Focal length [mm]	Field of view (H × V in [mm])	
	Object distance = 500 mm	Object distance = 1000 mm
8	698 × 438 mm	1407 × 884 mm
12	461 × 290 mm	933 × 586 mm
16	343 × 215 mm	697 × 438 mm
25	215 × 135 mm	442 × 278 mm
35	150 × 94 mm	312 × 196 mm
50	102 × 64 mm	215 × 135 mm

Table 123: Focal length versus field of view for Alvium 1800 U-234m/c and 1800 U-235m/c

## Alvium 1800 U-240m/c

Values for 1800 U-240m/c cameras with Type 1/2.3 (7.9 mm diagonal) sensors:

Focal length [mm]	Field of view (H × V in [mm])	
	Object distance = 500 mm	Object distance = 1000 mm
4.8	691 × 433	1389 × 871
6	552 × 346	1110 × 696
8	412 × 258	831 × 521
12	272 × 171	552 × 346
16	203 × 127	412 × 258
25	127 × 80	261 × 164
35	89 × 56	185 × 116
50	60 × 38	127 × 80

Table 124: Focal length versus field of view for Alvium 1800 U-240m/c

## Alvium 1800 U-291m/c

Values for 1800 U-291m/c cameras with Type 2/3 (10.8 mm diagonal) sensors:

Focal length [mm]	Field of view (H × V in [mm])	
	Object distance = 500 mm	Object distance = 1000 mm
6	644 × 642	1296 × 1293
8	481 × 480	970 × 968
12	318 × 317	644 × 642
16	237 × 236	481 × 480
25	149 × 148	305 × 304
35	104 × 104	216 × 215
50	70 × 70	149 × 148

Table 125: Focal length versus field of view for Alvium 1800 U-291m/c

## Alvium 1800 U-319m/c

Values for 1800 U-319m/c cameras with Type 1/1.8 (8.9 mm diagonal) sensors:

Focal length [mm]	Field of view (H × V in [mm])	
	Object distance = 500 mm	Object distance = 1000 mm
4.8	735 × 550	1476 × 1104
6	586 × 439	1180 × 882
8	438 × 328	883 × 661
12	290 × 217	586 × 439
16	215 × 161	438 × 328
25	135 × 101	278 × 208
35	95 × 71	196 × 147
50	64 × 48	135 × 101

Table 126: Focal length versus field of view for Alvium 1800 U-319m/c

## Alvium 1800 U-320 VSWIR

Values for 1800 U-320VSWIR cameras with Type 1/1.8 (8.9 mm diagonal) sensors:

Focal length [mm]	Field of view (H × V in [mm])	
	Object distance = 500 mm	Object distance = 1000 mm
6	591 × 439	1189 × 882
8	441 × 328	890 × 661
12	292 × 217	591 × 439
16	217 × 161	441 × 328
25	136 × 101	280 × 208
35	95 × 71	198 × 147
50	65 × 48	136 × 101
75	41 × 30	89 × 66

Table 127: Focal length versus field of view for Alvium 1800 U-320 VSWIR



## Alvium 1800 U-500m/c, -501m/c NIR

Values for 1800 U-500m/c and -501m/c NIR cameras with Type 1/2.5 (7.1 mm diagonal) sensors:

Focal length [mm]	Field of view (H × V in [mm])	
	Object distance = 500 mm	Object distance = 1000 mm
2.8	1013 × 759	2031 × 1523
3.6	786 × 590	1578 × 1184
4.8	588 × 441	1182 × 887
6	469 × 352	945 × 709
8	351 × 263	707 × 530
12	232 × 174	469 × 352
16	172 × 129	351 × 263
25	108 × 81	222 × 167

Table 128: Focal length versus field of view for Alvium 1800 U-500m/c, -501m/c NIR

## Alvium 1800 U-507m/c, -507m/c Pol, -508m/c, -508m/c Pol

Values for 1800 U-507m/c, -507m/c Pol, -508m/c, and -508m/c Pol cameras Type 2/3 (11.1 mm diagonal) sensors:

Focal length [mm]	Field of view (H × V in [mm])	
	Object distance = 500 mm	Object distance = 1000 mm
6	700 × 584	1408 × 1175
8	523 × 436	1054 × 880
12	346 × 288	700 × 584
16	257 × 215	523 × 436
25	162 × 135	332 × 277
35	113 × 94	234 × 196
50	77 × 64	162 × 135

Table 129: Focal length versus field of view for Alvium 1800 U-507m/c, -507m/c Pol, -508m/c, -508m/c Pol

## Alvium 1800 U-510m/c, -511m/c

Values for 1800 U-510m/c and -511m/c cameras with Type 1/1.8 (8.8 mm diagonal) sensors:

Focal length [mm]	Field of view (H × V in [mm])	
	Object distance = 500 mm	Object distance = 1000 mm
5	671 × 560	1348 × 1125
6	558 × 466	1122 × 937
8	417 × 348	840 × 701
12	275 × 230	558 × 466
16	205 × 171	417 × 348
25	129 × 107	264 × 221
35	90 × 75	187 × 156
50	61 × 51	129 × 107

Table 130: Focal length versus field of view for Alvium 1800 U-510 m/c, -511m/c

## Alvium 1800 U-530 VSWIR

Values for 1800 U-530 VSWIR cameras with Type 1/1.4 (11.4 mm diagonal) sensors:

Focal length [mm]	Field of view (H × V in [mm])	
	Object distance = 500 mm	Object distance = 1000 mm
6	736 × 584	1481 × 1175
8	550 × 436	1109 × 880
12	364 × 288	736 × 584
16	271 × 215	550 × 436
25	170 × 135	349 × 277
35	119 × 94	247 × 196
50	80 × 64	170 × 135
75	51 × 40	110 × 87

Table 131: Focal length versus field of view for Alvium 1800 U-530 VSWIR

## Alvium 1800 U-811m/c, -812 UV

Values for 1800 U-811m/c and -812 UV cameras with Type 2/3 (11.0 mm diagonal) sensors:

Focal length [mm]	Field of view (H × V in [mm])	
	Object distance = 500 mm	Object distance = 1000 mm
5	773 × 773	1553 × 1553
6	642 × 642	1293 × 1293
8	480 × 480	968 × 968
12	317 × 317	642 × 642
16	236 × 236	480 × 480
25	148 × 148	304 × 304
35	104 × 104	215 × 215
50	70 × 70	148 × 148

Table 132: Focal length versus field of view for Alvium 1800 U-811m/c, -812 UV

## Alvium 1800 U-895m/c

Values for 1800 U-895m/c cameras with Type 1 (16.0 mm diagonal) sensors:

Focal length [mm]	Field of view (H × V in [mm])	
	Object distance = 500 mm	Object distance = 1000 mm
12	577 × 305	1168 × 618
16	429 × 227	873 × 462
25	270 × 143	553 × 293
35	189 × 100	391 × 286
50	128 × 68	270 × 143
100	57 × 30	128 × 68
135	38 × 20	91 × 48

Table 133: Focal length versus field of view for Alvium 1800 U-895m/c

## Alvium 1800 U-1236m/c

Values for 1800 U-1236m/c cameras with Type 1.1 (17.6 mm diagonal) sensors:

Focal length [mm]	Field of view (H × V in [mm])	
	Object distance = 500 mm	Object distance = 1000 mm
8	872 × 638	1759 × 1287
12	577 × 422	1168 × 854
16	429 × 314	872 × 638
25	270 × 197	553 × 405
35	188 × 138	391 × 286
50	128 × 93	270 × 197
75	80 × 59	175 × 128

Table 134: Focal length versus field of view for Alvium 1800 U-1236m/c

## Alvium 1800 U-1240m/c

Values for 1800 U-1240m/c cameras with Type 1/1.7 (9.33 mm diagonal) sensors:

Focal length [mm]	Field of view (H × V in [mm])	
	Object distance = 500 mm	Object distance = 1000 mm
4.8	763 × 578	1534 × 1161
6	609 × 461	1226 × 928
8	455 × 344	918 × 694
12	301 × 228	609 × 461
16	224 × 169	455 × 344
25	141 × 106	289 × 218
35	98 × 74	204 × 154
50	67 × 50	141 × 106

Table 135: Focal length versus field of view for Alvium 1800 U-1240m/c

## Alvium 1800 U-1242m/c

Values for 1800 U-1242m/c cameras with Type 1/1.1 (14.0 mm diagonal) sensors:

Focal length [mm]	Field of view (H × V in [mm])	
	Object distance = 500 mm	Object distance = 1000 mm
6	931 × 679	1874 × 1365
8	696 × 507	1403 × 1022
12	460 × 335	931 × 679
16	342 × 249	696 × 507
25	215 × 157	441 × 321
35	150 × 109	312 × 227
50	102 × 74	215 × 157
75	64 × 47	139 × 102

Table 136: Focal length versus field of view for Alvium 1800 U-1242m/c

## Alvium 1800 U-1620m/c

Values for 1800 U-1620m/c cameras with Type 1.1 (16.8mm diagonal) sensors:

Focal length [mm]	Field of view (H × V in [mm])	
	Object distance = 500 mm	Object distance = 1000 mm
5	1445 × 825	2905 × 1658
6	1202 × 686	2419 × 1380
8	898 × 512	1810 × 1033
12	594 × 339	1202 × 686
16	442 × 252	898 × 512
25	277 × 158	569 × 325
35	194 × 111	403 × 230
50	131 × 75	277 × 158
75	83 × 47	180 × 103

Table 137: Focal length versus field of view for Alvium 1800 U-1620m/c

## Alvium 1800 U-2040m/c

Values for 1800 U-2040m/c cameras with Type 1.1 (17.5 mm diagonal) sensors:

Focal length [mm]	Field of view (H × V in [mm])	
	Object distance = 500 mm	Object distance = 1000 mm
6	1018 × 1018	2048 × 2048
8	760 × 760	1533 × 1533
12	503 × 503	1018 × 1018
16	374 × 374	760 × 760
25	235 × 235	482 × 482
35	164 × 164	341 × 341
50	111 × 111	235 × 235
75	70 × 70	152 × 152
85	60 × 60	133 × 133

Table 138: Focal length versus field of view for Alvium 1800 U-2040m/c

## Alvium 1800 U-2050m/c

Values for 1800 U-2050m/c cameras with Type 1 (15.9 mm diagonal) sensors:

Focal length [mm]	Field of view (H × V in [mm])	
	Object distance = 500 mm	Object distance = 1000 mm
8	811 × 542	1636 × 1093
12	536 × 358	1086 × 726
16	399 × 267	811 × 542
25	251 × 167	514 × 344
35	175 × 117	364 × 243
50	119 × 79	251 × 167
75	75 × 50	163 × 109
85	64 × 43	142 × 95
100	53 × 35	119 × 79

Table 139: Focal length versus field of view for Alvium 1800 U-2050m/c

## Alvium 1800 U-2460m/c

Values for 1800 U-2460m/c cameras with Type 1.2 (19.3 mm diagonal) sensors:

Focal length [mm]	Field of view (H × V in [mm])	
	Object distance = 500 mm	Object distance = 1000 mm
8	898 × 776	1810 × 1566
12	594 × 513	1202 × 1040
16	442 × 382	898 × 776
25	277 × 240	569 × 492
35	194 × 168	403 × 348
50	131 × 114	277 × 240
75	83 × 72	180 × 156

Table 140: Focal length versus field of view for Alvium 1800 U-2460m/c

# Installing the camera



This chapter includes:

Touching hot cameras .....	257
Sensor damage by ESD.....	257
Bare board cameras .....	257
Mounting the heat sink.....	259
Mounting the camera .....	260
Mounting the lens.....	265
Software and driver installation on the host .....	269



## Touching hot cameras



### CAUTION

#### Risk of burns

A camera in operation can reach temperature levels which could cause burns.

- Wear protective gloves when you touch a camera that is heated up.
- Ensure proper cooling of the camera.

## Sensor damage by ESD



### NOTICE

#### Possible damage to the sensor

In Alvium USB cameras without a closed housing, sensors can be damaged by ESD. In the output image, this may become visible as bubbles or blobs, for example. For details, see the note in [Possible damage to image sensors due to electrostatic charge](#) on page 60.

- Provide ESD protection measures in accordance with technical standards.
- Follow the instructions in [ESD](#) on page 56.

## Bare board cameras

If you intend to design an application using bare board cameras, please consider:

- Alvium bare board cameras are not aligned. You must align these cameras into housings individually, which is extremely difficult and expensive. As a possible solution, Alvium Frame cameras provide alignment areas and holes to fit into individual housings, see [Alvium Frame- use your own optical mount](#) on page 19.
- Aligning the sensor to the lens is extremely difficult and expensive. Therefore, we recommend you to do evaluation with housed cameras first.
- Bare board cameras are specialized components. We cannot give all data needed for any application in advance.
- Please let us partner with you for bare board camera applications to ensure a successful design.

## Serial numbers of Alvium® chips and bare board cameras

Bare board cameras do not have enough space for a label with all the required information. Therefore, they are shipped with a 25 mm × 25 mm sandwich label on the blister pack. In [Figure 83](#), this label shows, for example:

- Product code: 14767 for a 1800 U-240c Bare Board 90 °Camera
- Alvium® chip SN (serial number): 183603543
- Camera SN (serial number): R7QW5 as digits and 2D code.

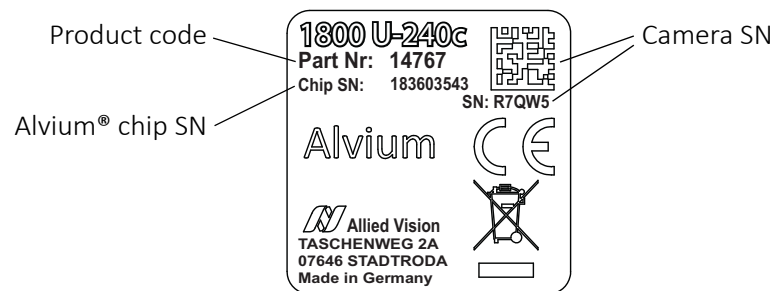
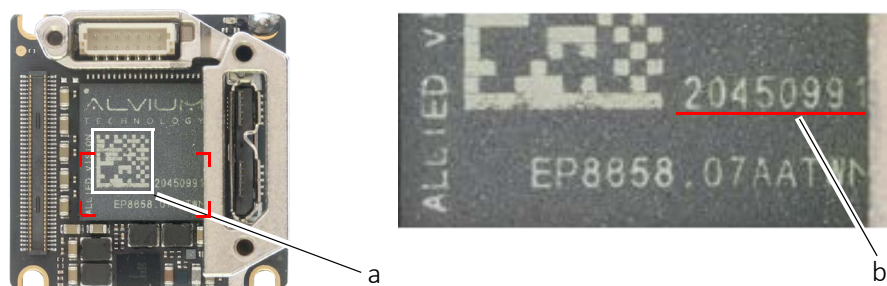

*Figure 83: Sandwich label on blister packs shipped for bare board cameras*

Before operating the camera, we recommend you to pull the sandwich label off the blister pack and stick it close to the camera.

If the label is lost, please read out with your smart phone the serial number of the Alvium® chip from the 2D code (a) shown in [Figure 84](#). With this number, we can look up the serial number of the camera in our database.

If your smart phone cannot read the 2D code: In [Figure 84](#), for example, the serial number (b) is 20450991.



*Figure 84: Alvium® chip imprint with detail view (right)*

## Mounting the heat sink

Keep the operating temperature in the specified range to enable best image quality and to protect the camera from damage. We recommend you to equip Alvium bare board and open housing cameras with heat sinks.



### Optimizing heat dissipation

For details, see the Optimum Heat Dissipation for Housed Alvium Cameras application note at [www.alliedvision.com/en/support/technical-documentation/alvium-usb-documentation](http://www.alliedvision.com/en/support/technical-documentation/alvium-usb-documentation).



#### NOTICE

##### Damage to the camera by heat sinks mounted improperly

- Allow mechanical contact only at the cooling area.
- Avoid any mechanical stress to the sensor and electronics area.
- Avoid short circuits of the electronics components.



#### NOTICE

##### Damage to the sensor, filter, and lens by corrosive substances

Some conductive media for heat sinks contain corrosive substances that can damage optical surfaces of the sensor, filter, and lens.

- Cover the optical path of the camera when you apply heat sink compound or adhesive to prevent substances and fumes from damaging optical surfaces.
- Adhere to the instructions and safety notes provided by the manufacturer of the conductive media.



#### NOTICE

##### Damage to camera electronics

Heat sinks can cause short circuits if they are not electrically isolated.

Avoid electrical contact between electronic components by unsuitable heat sinks and thermal conductive media.

Connect components in the cooling area (blue area in [Figure 85](#)) to a heat sink, following the instructions of the manufacturer of the heat sink and the thermal conductive media. Cooling area for Alvium USB 90° models are the same as for standard models.

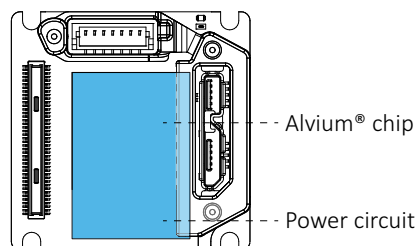

Figure 85: Cooling area for Alvium USB bare board cameras



### Heat sink compound

Because electronic parts vary in height, we have updated our recommendation:

- Use flexible heat sink compound to compensate for potential gaps between the electronic parts to be cooled and heat sinks.
- Consider 1 mm to cover for worst case scenarios.
- For details, see the Alvium STEP files at [www.alliedvision.com/en/support/alvium-step-file-downloads](http://www.alliedvision.com/en/support/alvium-step-file-downloads).

## Mounting the camera



### CAUTION

#### Injury by falling cameras or lenses

A falling camera or lens can cause injury.

- Ensure proper mounting of cameras and lenses, especially for dynamic applications.
- Mount cameras as described in the instructions.
- Always make sure the mounting threads are intact.
- Fasten screws with maximum torque, using the entire thread engagement. For less thread engagement, see [Adapting maximum torque values](#) on page 265.
- We recommend you to apply thread locking.
- Use a lens support for heavy lenses.

## Mounting bare board cameras



#### Heat dissipation and electromagnetic compatibility for bare board cameras

For heat dissipation, see the Optimum Heat Dissipation for Alvium Cameras application note.

For initial guidance on electromagnetic compatibility, see the Electromagnetic Compatibility for Open Housing Alvium Cameras application note.

See [www.alliedvision.com/en/support/technical-documentation/alvium-usb-documentation](http://www.alliedvision.com/en/support/technical-documentation/alvium-usb-documentation).

**NOTICE**
**Damage to the camera by improper mounting**

- Allow mechanical contact only at the mounting area.
- Avoid any mechanical stress to the sensor and the electronics area.
- Avoid short circuits of the electronics components.
- Give 2 mm minimum clearance above board components.
- Tighten screws at 0.1 Nm maximum torque.

**Sensor alignment for bare board cameras**

The sensors in Alviium bare board cameras are not aligned to a lens mount. You must align these cameras into housings individually, which can be difficult and expensive. As a possible solution, Alviium Frame cameras provide alignment areas and holes to fit into individual housings, see [Alviium Frame- use your own optical mount](#) on page 19.

Schematic drawings in [Figure 86](#) show Alviium USB bare board cameras. Only the mounting area (gray) can be used for mounting. The sensor and electronics area (red) must not be touched nor put at mechanical stress.

a = Mounting hole | b = Mounting hole and chassis ground

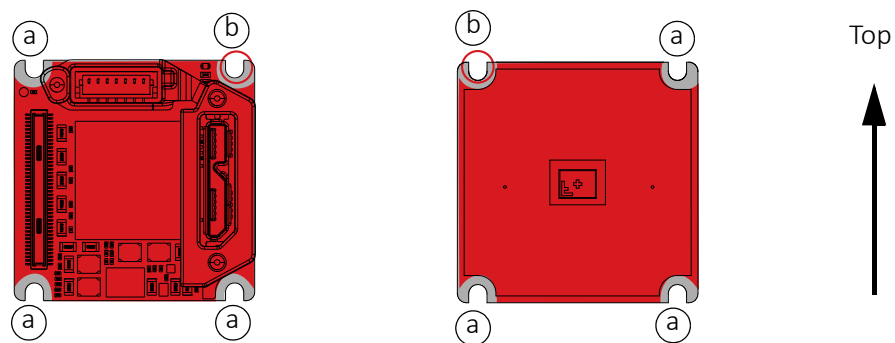

*Figure 86: Mounting area of Alviium USB bare board cameras connector side (left); sensor side (right)*

Mount the bare board with four M1.6 screws at 0.1 Nm maximum torque. Mounting areas for Alviium USB 90° models are the same as for standard models.

## Mounting housed standard cameras

### Bottom or top mounting

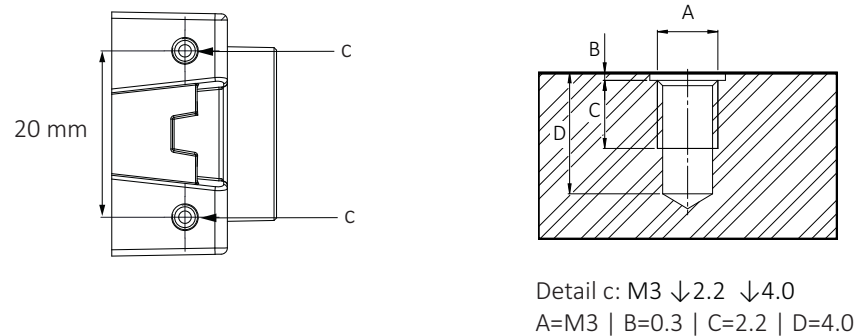

Figure 87: Top and bottom and mounting threads (c)

**The maximum torque value applies only if the entire thread engagement is used.** For other values, see [Adapting maximum torque values](#) on page 265.

1. Mount the camera to the base using suitable M3 screws at 0.51 Nm maximum torque for a thread engagement (C) of 2.2 mm between screws and mounting threads, see [Figure 87](#). For technical drawings, see [Standard Alviium: Dimensions and mass](#) on page 205.
2. Continue with [Mounting the lens](#) on page 265.

### Front mounting

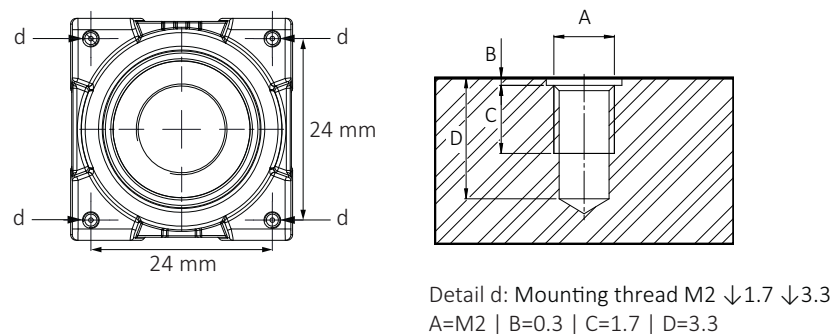

Figure 88: Camera front with mounting threads (d)

**The maximum torque value applies only if the entire thread engagement is used.** For other values, see [Adapting maximum torque values](#) on page 265.

1. Mount the camera to the base using suitable M2 screws at 0.17 Nm maximum torque for a thread engagement (C) of 1.7 mm between screws and mounting threads, see [Figure 88](#). For technical drawings, see [Standard Alviium: Dimensions and mass](#) on page 205.  
We recommend you to additionally use bottom and top mounting threads for a more solid connection.
2. Continue with [Mounting the lens](#) on page 265.

## Installing Alvium Frame cameras



### CAUTION

#### Risk of cuts by sharp edges of the circular front opening

- Avoid touching these edges with your fingers.
- Wear protective gloves for handling Alvium Frame cameras with an open circular front opening.



### NOTICE

#### Damage to the sensor

The sensor can be damaged if the sensor surface is exposed to dirt or mechanical stress.

- Ensure that lenses or objects, such as optical elements do not exceed the specified maximum protrusion.
- Keep your fingers and tools outside the area inside the frame flange.
- Provide the following conditions to keep dirt and droplets out of the optical system of camera:
  - Dust-free environment
  - Low relative humidity
  - No condensation.

## Aligning the sensor with your optical system

Alvium Frame cameras are manufactured so that the sensor is aligned with your optical system with optimal precision. You can select between alignment methods:

**A:** Using the lateral alignment areas (1) and the front alignment area (2).

**B:** Using the front area (2) and the two alignment holes (3).

**A** Alignment by using the lateral alignment areas (1) and the front area (2)

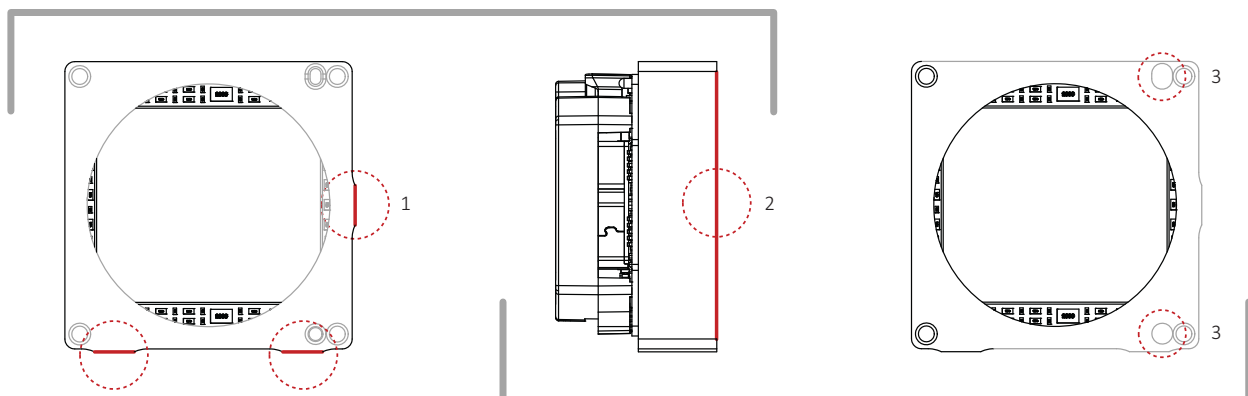

**B** Alignment by using the front area (2) and the alignment holes (3)

Figure 89: Alignment methods



### Dimensions and accuracy

For the dimensions and accuracy of the alignment areas and the alignment holes, see [Alvium Flex: Technical drawings](#) on page 222.

For the accuracy of the sensor position, see [Housed standard and Flex cameras: Sensor shift and rotation](#) on page 232 and [Housed Alvium USB cameras: Sensor tilt](#) on page 233.

When you design Alvium Frame cameras into your system, observe values for:

- Flange focal distance, optical: 3.576 mm
- Maximum protrusion of 1.5 mm into the frame measured from the front area (2).

## Mounting Alvium Frame

Especially for dynamic applications with high acceleration, mount the camera using all 4 mounting threads.

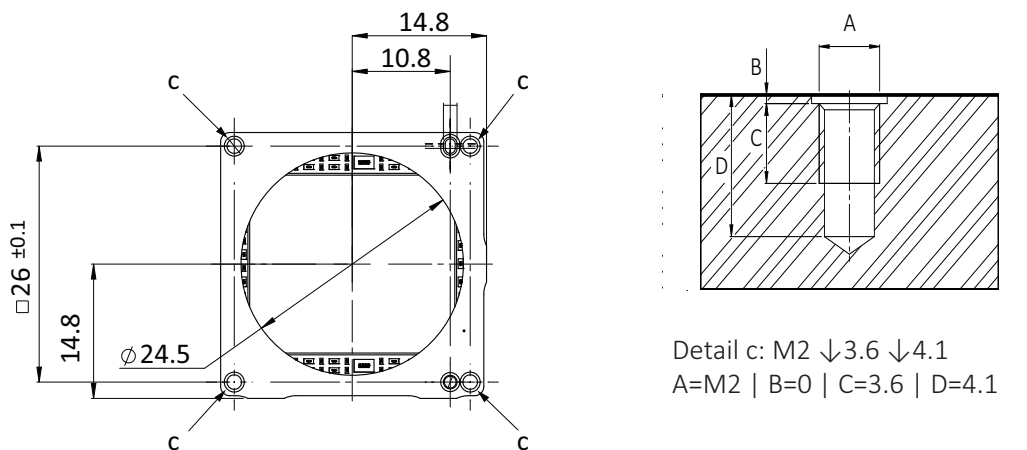

Figure 90: Mounting threads Alvium Frame

**The maximum torque value applies only if the entire thread engagement is used.** For other values, see [Adapting maximum torque values](#). For technical drawings, with further values and tolerances, and references for alignment, see [Alvium Frame: Technical drawings](#) on page 227.

As shown in [Figure 90](#), mount the camera to the base using suitable M2 screws for the 4 mounting threads: At 0.4 Nm maximum torque for a thread engagement (C) of 3.6 mm between screws and mounting threads.



## Adapting maximum torque values

This is a general example. Use the corresponding values for your camera. The total screw length composes of the mounting holes length and the height of your mounting base. For using less than the recommended length of thread engagement, calculate maximum torque as follows:

$$\frac{\text{Current length of thread engagement}}{\text{Length of thread engagement in table}} \times \text{Torque in table} = \text{Current torque}$$

Example for a length of thread engagement of **1.4 mm** instead of 1.7 mm:

$$1.4 \text{ mm} / 1.7 \text{ mm} \times 0.17 \text{ Nm} = \mathbf{0.14 \text{ Nm}}$$

Thread group	Thread position	Thread type	Total protrusion	Length of thread engagement	Maximum torque
d	Front mounting	M2	2 mm	1.7 mm	0.17 Nm
d	Front mounting	M2	2 mm	<b>1.4 mm</b>	<b>0.14 Nm</b>

Table 141: Adjusting maximum torque values

To ensure that the screws do not become loose over time, we recommend you to use means for securing screws, such as screw locking varnish.



### Tripod adapter

For more information, see [www.alliedvision.com/en/products/accessories](http://www.alliedvision.com/en/products/accessories).

## Mounting the lens

Observe the following notes before you mount lenses to Alvium USB cameras.



### CAUTION

#### Injury by falling cameras or lenses

A falling camera or lens can cause injury.

- Ensure proper mounting of cameras and lenses, especially for dynamic applications.
- Mount cameras as described in the instructions.
- Use a lens support for heavy lenses.



### CAUTION

#### Risk of cuts by sharp edges of lens mounts

The threads of the lens mount can have sharp edges.  
Be careful when mounting or unmounting lenses.



### NOTICE

#### Damage to sensor, optics, or electronics by unsuitable lenses

The sensor, filter, lens, or electronics can be damaged if a lens exceeding maximum protrusion is mounted to the camera.

- Use lenses only up to the specified maximum protrusion, see [Maximum protrusion for front mounts](#) on page 230.
- S-Mount lenses must be screwed into the camera at less than max. protrusion (11.0 mm), see [Mounting and focusing S-Mount lenses](#) on page 266.
- Avoid short S-Mount lenses falling into the camera.

## Mounting and focusing S-Mount lenses



#### Allied Vision S-Mount lenses

For technical data of Allied Vision S-Mount lenses with dedicated operating instructions, see the S-Mount Lenses User Guide at [www.alliedvision.com/fileadmin/content/documents/products/accessories/lenses/Allied\\_Vision/Data\\_sheet/S-Mount-Lenses\\_User-Guide.pdf](http://www.alliedvision.com/fileadmin/content/documents/products/accessories/lenses/Allied_Vision/Data_sheet/S-Mount-Lenses_User-Guide.pdf).

This section instructs how to use S-Mount lenses with your camera safely. S-Mount lenses are screwed into the mount to adjust focus. Vibration moves lenses out of position. Several techniques can be used to fasten S-Mount lenses in focus. We recommend using fixing nuts. See instructions in this section.



#### Drawings and fixing nuts

- Drawings in the instructions are schematic.
- Several manufacturers offer various types of S-Mount fixing nuts. The type shown in the instructions drawings is an example.
- We recommend using pinch nose pliers to tighten fixing nuts.

Figure 91 shows how fixing nuts lock S-Mount lenses.  
Follow the instructions to lock the lens in focus position.

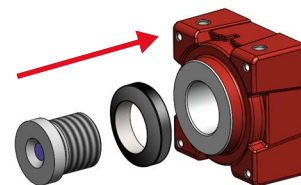

Figure 91: Fixing nut locking an S-Mount lens

**NOTICE**
**Damage to sensor, optics, or electronics by improper handling**

If an S-Mount lens is screwed against the sensor or electronics, sensor, lens, or electronics can be damaged.

- Screw in the lens at less than 11.0 mm maximum protrusion.
- Follow the instructions carefully.

**Determining the allowed range for the position of the lens**

1. Measure the length of the lens.
2. Calculate:  $a = c - b$   
 a: length of the mounted lens, measured from lens mount front flange  
 b: maximum protrusion (11.0 mm)  
 c: length of the lens

See [Maximum protrusion for front mounts](#) on page 230.

3. Set a gauge to the length of (a).

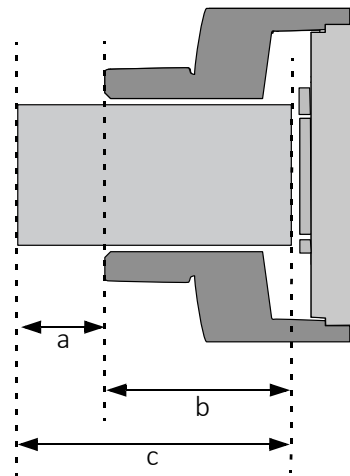

Figure 92: S-Mount lens and maximum protrusion

**Mounting the fixing nut to the lens**

4. Screw the fixing nut clockwise onto the lens until you can hold the front part (d) of the lens with your finger tips.



Figure 93: Lens and fixing nut

**Focusing the lens**

5. **Checking (a) with a gauge**, slowly screw the lens clockwise into the lens mount until the image is roughly in focus.
6. Slowly screw in and unscrew the lens until you have found the most accurate focus.

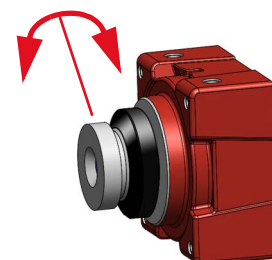

Figure 94: Adjusting focus

**NOTICE**
**Damage to lens threads and fixing nut by excessive force**

If the fixing nut is screwed with too much force, threads are worn out and the lens cannot be locked anymore.

Screw fixing nuts hand tight to keep the lens in a fixed position.

**Locking focus**

Pinch nose pliers are used to screw the fixing nut:

7. Holding the lens in position with one hand, screw the fixing nut clockwise against the lens mount until you feel the lens is locked.

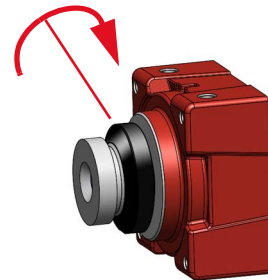

Figure 95: Tightening the fixing nut

**Checking focus is set and locked properly**

8. Check No.1: Try to rotate the lens with little force in both directions to ensure the lens is safely locked in position.

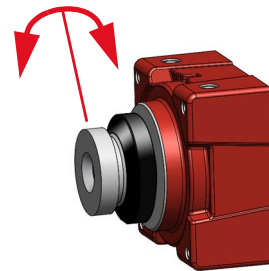

Figure 96: Checking lens is safely locked

9. Check No. 2: S-Mount thread allows a slightly tilted lens position. In this case, focus for a common object plane varies over the image plane.

**If focus is constant** over the image plane, you are done.

**If focus varies** over the image plane, the lens is tilted. Continue with 10.

10. Loosen the fixing nut.
11. Continue with 6.

The lens is locked in focus and ready for operation.

# Software and driver installation on the host



## Easy camera access with Vimba X

This section lists general requirements to operate Alviium USB cameras on your system.

To download **Vimba X SDK** for Windows, Linux, and Linux/ARM, including **Vimba X Viewer**, **Firmware Updater**, and **Driver Installer** for Windows, see [www.alliedvision.com/en/products/software/vimba-x-sdk](http://www.alliedvision.com/en/products/software/vimba-x-sdk).

For more details see **ReleaseNotes\_Linux.txt** or **ReleaseNotes\_Windows.txt** in the directory of your **Vimba X** installation, or see [www.alliedvision.com/en/products/software/vimba-x-sdk](http://www.alliedvision.com/en/products/software/vimba-x-sdk).

## Required components



### Driver installation and OS support

**Windows:** Please use **Vimba X** to install the camera driver. For **Vimba X** system requirements and supported Windows versions, see [www.alliedvision.com/en/products/software/vimba-x-sdk](http://www.alliedvision.com/en/products/software/vimba-x-sdk).

**Linux:** Allied Vision does not provide a special driver. For **Vimba X** system requirements and supported operating systems, see [www.alliedvision.com/en/products/software/vimba-x-sdk](http://www.alliedvision.com/en/products/software/vimba-x-sdk).

You need the following accessories:

- USB 3.0 or 3.1 Gen 1 external host controller card or on-board host controller
- USB 3.0 or 3.1 Type-A to Micro-B cable.



### Compatible USB 3.0 or 3.1 Gen 1 accessories

See [www.alliedvision.com/en/products/accessories](http://www.alliedvision.com/en/products/accessories).

# Connecting the camera to the host

## Connecting USB cables

Providing sufficient **strain relief** to avoid camera damage:

Plug the Micro USB 3.0 connector of the USB cable to the camera and fasten the locking screws. Connect the other USB connector to the host.



### Compatible USB 3.0 cables

For USB 3.0 interface cables, industrial grade, with screw locks, Standard-A to Micro-B, see [www.alliedvision.com/en/products/accessories](http://www.alliedvision.com/en/products/accessories).

## Installing the camera driver using Vimba X on a Windows system

Instructions in this chapter describe installation of the camera driver using **Vimba X** on a Windows system. On Linux systems, the generic driver for USB3 Vision devices is used.



### Unexpected events

Should installation or operation not work properly, see [Performance and troubleshooting](#) on page 299.

## Using the camera with third-party drivers

Alvium USB cameras may not support third-party drivers. We recommend using the **Vimba X** camera driver.

## Installing drivers for camera and host adapter

### Installing the host adapter and Vimba X

1. Install the USB 3.0 or 3.1 Gen 1 host controller card and driver according to the manufacturer's instructions.
2. Download and install **Vimba X**: [www.alliedvision.com/en/products/software/vimba-x-sdk](http://www.alliedvision.com/en/products/software/vimba-x-sdk)
3. Continue with [Installing the camera driver](#).

## Installing the camera driver



### Connecting the camera to a USB 2.0 port

If the Alvim USB camera is connected to a USB 2.0 port, the **Vimba X** driver can be installed and the camera can be configured and operated. But for full performance, the camera must be connected to a USB 3.0 or 3.1 Gen 1 port.



### Command line driver installer

**Vimba X** also provides a command line driver installer. For more information about the **Vimba X Driver Installer**, see the manual, included in the **Vimba X** download.

During the **Vimba X** installation, select at least **camera demonstration** and **Vimba X applications** to operate Alvim USB cameras. If the camera is not recognized or to subsequently change an assigned driver, follow the instructions:

1. Connect your Alvim USB camera to the computer using a USB 3.0 or 3.1 Type-A to Micro-B cable.
2. Start **Vimba X Driver Installer** and open the **USB3 Vision Cameras** tab. The **Driver Source** is not installed, yet. If other USB3 Vision devices are installed, another USB3 Vision driver may be assigned to your camera.
3. Click the Alvim USB camera entry. The current **Vimba X** driver is offered as a popup (Vimba 3.0.0 in the example).
4. Open **Install driver > USB3 Vision Camera** and click the driver popup.

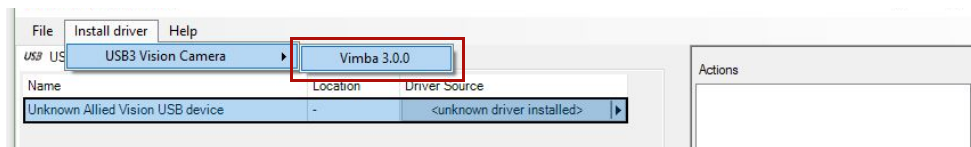

Figure 97: Vimba X Driver Installer, camera driver not installed

5. Click **Apply** to install the **Vimba X** driver for the camera.

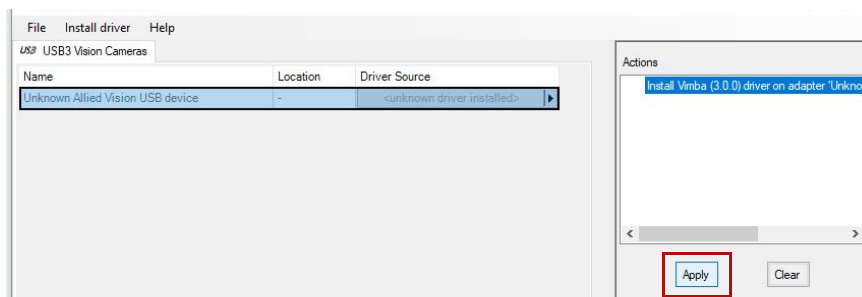

Figure 98: Vimba X Driver Installer, driver installation started

The driver has been installed successfully, the camera is recognized.

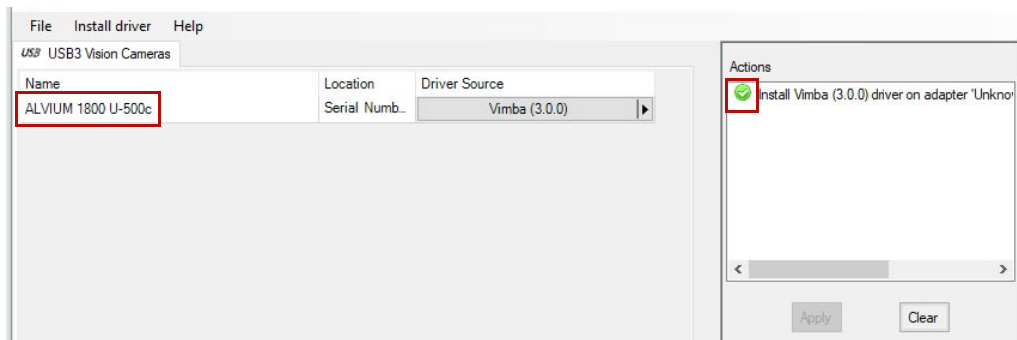

Figure 99: Vimba X Driver Installer, driver installed successfully



### Manual Vimba X driver installation

Windows: For manual **Vimba X** driver installation, see the following instructions.



## Installing the camera driver with Windows tools

As an alternative practice, you can install the **Vimba X** driver manually. Check for connected USB devices on your Windows system.



### Screenshots are examples

The following screenshots were taken on a test system. The view may be different, depending on the configuration of your system.

Under Windows, the **Device Manager** provides an overview of USB resources and connected devices. As long as the **Vimba X** USB device driver is not installed, the camera is not recognized.

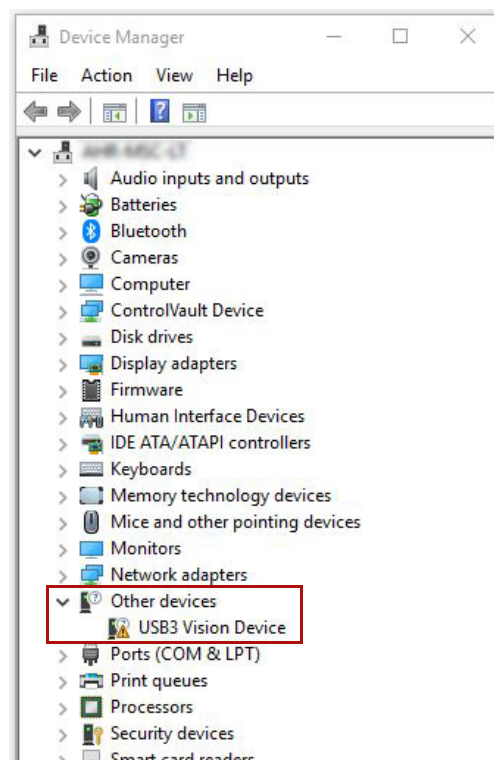

Figure 100: Windows Device Manager, unrecognized USB3 Vision camera

If no **USB3 Vision Device** is shown under the section **Other devices**, continue with action step 1. Otherwise, continue with action step 3.

1. Look at the section **Universal Serial Bus controllers**.
2. Disable the new found **USB Composite Device** and enable it again.  
This creates the entry under the section **Other Devices** as shown in [Figure 100](#).

- Right-click the unrecognized **USB3 Vision Device** and select *Update driver*.

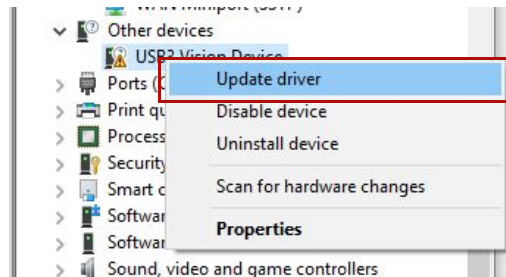

Figure 101: Windows Device Manager, Windows Driver Installer

- Click: “Browse my computer for driver software”.
  - Select [Your local Vimba X directory]\Allied Vision\Vimba X\Driver.
  - Follow the instructions.
- The camera driver is installed successfully.

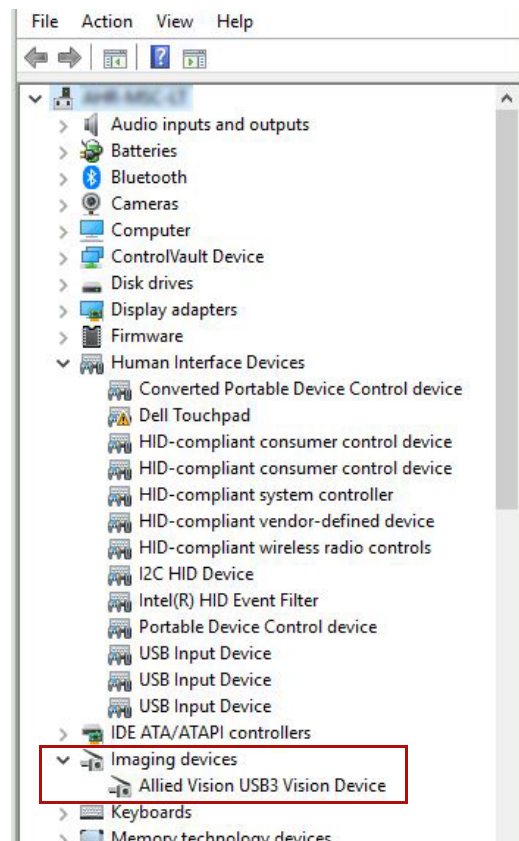

Figure 102: Windows Device Manager, USB3 Vision camera installed successfully

# Camera interfaces



This chapter includes:

Standard Alvium and Alvium Frame: Connections .....	276
Alvium Flex: Connections .....	279
All Alvium USB: Connections .....	283

# Standard Alvium and Alvium Frame: Connections

## Recommended accessories



### Compatible electronics accessories

See [www.alliedvision.com/en/products/accessories](http://www.alliedvision.com/en/products/accessories).

## Back panel

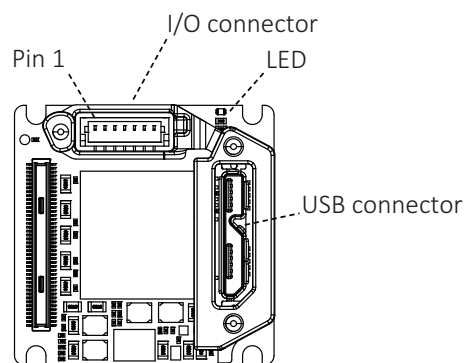

Figure 103: Bare board camera

## Interface descriptions

Interface	Section in this user guide
I/O connector	<a href="#">Non-isolated, programmable GPIOs on page 284</a>
Status LED	<a href="#">Status LED on page 286</a>

Table 142: Interface descriptions overview

For I/O connector pin assignment, see [I/O connector pin assignment](#) on page 277.

## I/O connector pin assignment



### I/O connector details

JST BM07B-SRSS-TBT connector set consists of:

- Camera connector: JST BM07B-SRSS-TBT
- Cable housing: JST SHR-07V-S
- Cable, crimp contacts: JST SSH-003T-P0.2-H

See [www.jst.de](http://www.jst.de) for details.



### I/O cables and electromagnetic interference (EMI)

Consider for I/O cables by Allied Vision:

- 12319 JST I/O cables without screw lock have no shielding and are designed to be used with bare board or open housing Alvium cameras.
- For applications without an additional EMC housing, use shielded cables, such as 12322 JST I/O cables **with screw lock**.



### NOTICE

#### Damage by reverse polarity

If Alvium USB cameras are externally powered with reverse polarity, the cameras can be damaged.

Power Alvium USB cameras according to the specifications described in this section.



### NOTICE

#### Damage by serial communication voltage levels

If you are using serial communication (UART, similar to RS232), keep voltage levels in the range defined in [Table 143](#) on page 278. Typical RS232 voltage levels (such as  $\pm 10$  VDC) are not supported without external circuitry.

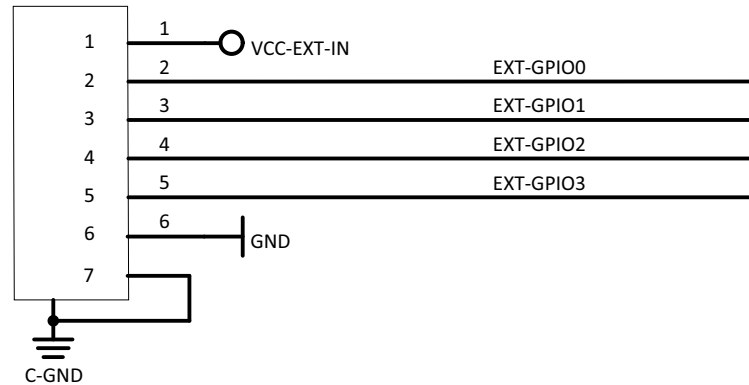

Figure 104: Pin assignment of JST BM07B-SRSS-TBT type I/O connector

Pin	Signal	Direction	Level	Description
1	VCC-EXT-IN	PWR IN	4.5 to 5.5 VDC See <a href="#">Power supply voltage for I/O cables</a> on page 283.	Power supply voltage See <a href="#">Camera power</a> on page 57.
2	EXT-GPIO0	IN/OUT	$U_{in} \text{ (low)} = -0.3 \text{ to } 0.8 \text{ VDC}$ $U_{in} \text{ (high)} = 2.0 \text{ to } 5.5 \text{ VDC}$ $U_{out} \text{ (low)} = 0 \text{ to } 0.4 \text{ VDC}$ $U_{out} \text{ (high)} = 2.4 \text{ to } 3.3 \text{ VDC at max. } 12 \text{ mA}$	GPIOs Internal pull-up resistor: 33 k $\Omega$ to 63 k $\Omega$
3	EXT-GPIO1	IN/OUT	See Pin 2, EXT-GPIO0	
4	EXT-GPIO2	IN/OUT	See Pin 2, EXT-GPIO0	
5	EXT-GPIO3	IN/OUT	See Pin 2, EXT-GPIO0	
6	GND	PWR	0 VDC	Power supply ground
7	C-GND	PWR	0 VDC	Chassis ground and shielding

Table 143: Pin assignment of the JST BM07B-SRSS-TBT type I/O connector

# Alvium Flex: Connections

## Observe for DF40C-50DP-0.4V connectors

Because using the Hirose DF40C-50DP-0.4V connector on Alvium Flex cameras is a novelty, no standard can be applied for the pinning. Therefore, connect your individual electronic parts only if you are an electronics expert. Otherwise, we recommend you to use boards and cables offered by Allied Vision for testing and evaluation, but also for final applications.



### Alvium Flex accessories

See the Alvium Flex Design and Accessory Guide at [www.alliedvision.com/en/support/technical-documentation/alvium-usb-documentation](http://www.alliedvision.com/en/support/technical-documentation/alvium-usb-documentation).

## Back panel

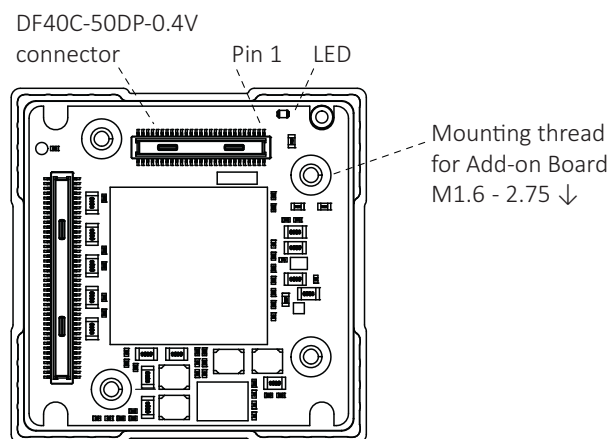

Figure 105: Alvium Flex camera back panel

## DF40C 50DP-0.4V connector pin assignment

Alvium USB Flex cameras have a 50-pin Hirose DF40C-50DP-0.4V connector.



### NOTICE

#### Damage to the camera by reverse polarity

If Alvium USB cameras or camera I/Os are powered with reverse polarity, camera electronics can be damaged.

- Use Alvium Flex accessories by Allied Vision.
- Observe polarity for camera and I/O power.

**NOTICE**
**Damage by serial communication voltage level**

If you are using serial communication (UART, similar to RS232), keep voltage levels in the range defined in [Table 143](#) on page 278. Typical RS232 voltage levels (such as  $\pm 10$  VDC) are not supported without external circuitry.

**More information on Hirose DF40C-50DP-0.4V connector**

- For instructions and electronic specifications of Alvim Flex accessories, see the Alvim Flex Design and Accessory Guide at [www.alliedvision.com/en/support/technical-documentation/alvim-usb-documentation](http://www.alliedvision.com/en/support/technical-documentation/alvim-usb-documentation).
- For technical data and more instructions on the Hirose DF40C-50DP-0.4V connector, see the manufacturer data sheet at [www.hirose.com](http://www.hirose.com).

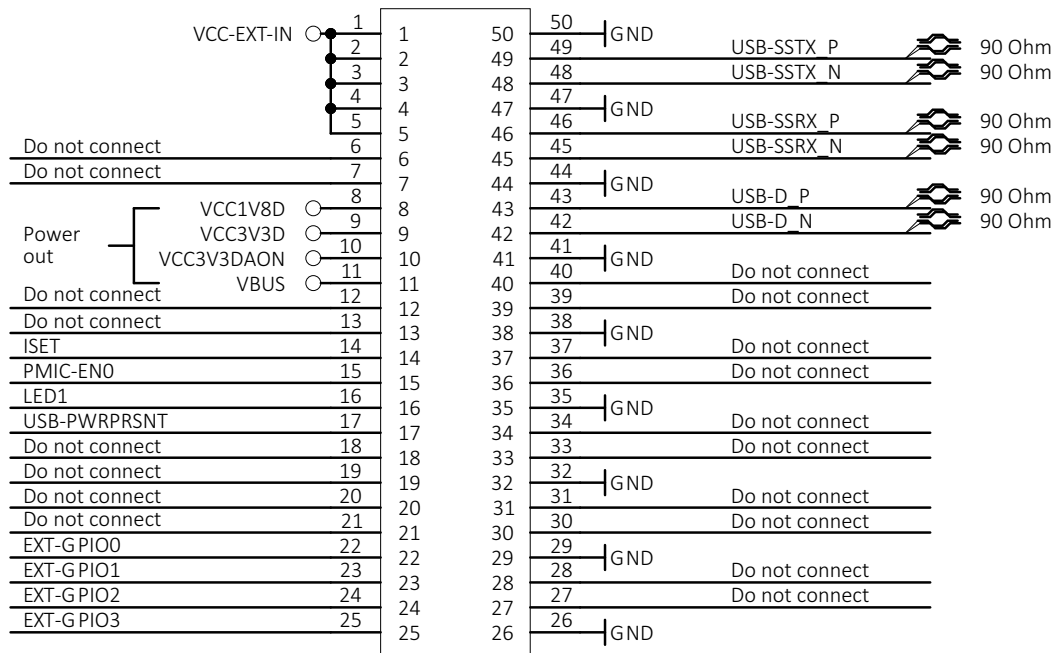

Figure 106: Hirose DF40C-50DP-0.4V connector pin assignment

**USB Receiver and Transmitter**

The signals for USB Receiver and Transmitter are seen from the camera side, as defined by the USB specification.



Pin	Signal	Direction	Level	Description
1 to 5	VCC-EXT-IN	PWR IN	4.5 to 5.5 VDC	Power supply voltage Maximum input current: 1.5 A
6	Do not connect			
7	Do not connect			
8	VCC1V8D	PWR OUT	max. 1.8 VDC	Power output Please contact Allied Vision Support if you want to use PWR OUT.
9	VCC3V3D	PWR OUT	max. 3.3 VDC	
10	VCC3V3DAON	PWR OUT	max. 3.3 VDC	
11	VBUS	PWR OUT	4.0 to 5.5 VDC	Power output Please contact Allied Vision Support if you want to use PWR OUT.
12	Do not connect			
13	Do not connect			
14	ISET	IN	Not applicable	To increase the camera's default internal current limit of 900 mA, connect an 820 Ω resistor to GND and add an external power supply.
15	PMIC-EN0	IN	$U_{in} (low) = -0.3$ to 0.4 VDC $U_{in} (high) = 1.4$ to 5.5 VDC	Camera power supply enable switch (active high, internal 100 kΩ pull-up resistor, default on)
16	LED1	OUT	3.3 VDC at 4 mA	Status LED output
17	USB-PWRPRSNT	IN	$U_{in} (low) = -0.3$ to 0.8 VDC $U_{in} (high) = 2.0$ to 5.5 VDC	Connect to USB-VBUS via resistor divider (R1 10 kΩ, R2 100 kΩ), add 100 nF capacitor to GND
18	Do not connect			
19	Do not connect			
20	Do not connect			
21	Do not connect			
22	EXT-GPIO0	IN/OUT	$U_{in} (low) = -0.3$ to 0.8 VDC $U_{in} (high) = 2.0$ to 5.5 VDC $U_{out} (low) = 0$ to 0.4 VDC $U_{out} (high) = 2.4$ to 3.3 VDC at max. 12 mA	GPIOs Internal pull-up resistor: 33 kΩ to 63 kΩ
23	EXT-GPIO1	IN/OUT		See Pin 22, EXT-GPIO0
24	EXT-GPIO2	IN/OUT		See Pin 22, EXT-GPIO0
25	EXT-GPIO3	IN/OUT		See Pin 22, EXT-GPIO0
26	GND	PWR	0 VDC	Power supply ground
27	Do not connect			
28	Do not connect			
29	GND	PWR	0 VDC	Power supply ground
30	Do not connect			
31	Do not connect			
32	GND	PWR	0 VDC	Power supply ground
33	Do not connect			
34	Do not connect			

Only signals shown in green must be connected for basic camera operation.

Table 144: Hirose DF40C-50DP-0.4V connector pin assignment (sheet 1 of 2)

Pin	Signal	Direction	Level	Description
35	GND	PWR	0 VDC	Power supply ground
36	Do not connect			
37	Do not connect			
38	GND	PWR	0 VDC	Power supply ground
39	Do not connect			
40	Do not connect			
41	GND	PWR	0 VDC	Power supply ground
42	USB-D_N	Defined by the USB specification		USB 2.0 differential pair
43	USB-D_P			
44	GND	PWR	0 VDC	Power supply ground
45	USB-SSRX_N	Defined by the USB specification		USB SuperSpeed receiver differential pair
46	USB-SSRX_P			
47	GND	PWR	0 VDC	Power supply ground
48	USB-SSTX_N	Defined by the USB specification		USB SuperSpeed transmitter differential pair
49	USB-SSTX_P			
50	GND	PWR	0 VDC	Power supply ground

Only signals shown in green must be connected for basic camera operation.

Table 144: Hirose DF40C-50DP-0.4V connector pin assignment (sheet 2 of 2)

# All Alvium USB: Connections

## I/O use for UART

Table 145 shows which values must be selected to control I/Os using LineSelector.

Signal	LineSelector (GenICam)	UART line
EXT-GPIO 0	Line0	Not applicable
EXT-GPIO 1	Line1	Not applicable
EXT-GPIO 2	Line2	UART Tx
EXT-GPIO 3	Line3	UART Rx

Table 145: Value settings to control I/Os using the LineSelector feature



### Feature descriptions

For more information in LineSelector and SerialHub features, see the Alvium Features Reference at [www.alliedvision.com/en/support/technical-documentation/alvium-usb-documentation](http://www.alliedvision.com/en/support/technical-documentation/alvium-usb-documentation).

## Power supply voltage for I/O cables

If you are using I/O cables, voltage drops may result, causing the following issues:

- The camera cannot be operated.
- The camera does not respond to trigger pulses.
- The output signal to control devices connected to the camera is not recognized.

### Compensation

To provide a proper power supply voltage, adjust the DC input voltage at the open ends of the cable as shown in Table 146.



### NOTICE

#### Damage to camera electronics

The following values apply to the Allied Vision I/O cables shown.

If you are using your own cables, ensure the power supply voltage at the camera connector side is 4.5 to 5.5 VDC.

Product code	Length	Cable type	Power supply voltage (at the open ends of the cable)
12319	0.4 m	7-Pin JST I/O cable without screw lock to open ends	4.5 to 5.5 VDC
12322	3.0 m	7-Pin JST I/O cable with screw lock to open ends	4.5 to 5.5 VDC
17070	5.0 m	7-Pin JST I/O cable with screw lock to open ends	5 to 5.5 VDC

Table 146: Adjusted values for power supply voltage by I/O cable length



### Technical data and ordering

For more information on 7-Pin JST I/O cables for Alviium USB cameras, see [www.alliedvision.com/en/products/accessories](http://www.alliedvision.com/en/products/accessories).

## Non-isolated, programmable GPIOs



### I/O cables maximum length

The maximum length for I/O cables must not exceed 30 meters.

### GPIOs description

The camera has four non-isolated GPIOs that can be configured by software to act as inputs or outputs.

Alviium GPIOs use the push-pull technology to switch the signal level between low and high. For low levels, the signal is "pulled" down towards ground level. For high levels, the signal is "pushed" up towards VCC level.

Alviium GPIOs feature the CMOS push-pull output drivers and Schmitt trigger inputs with an internal pull-up resistor and a filter circuit, shown in Figure 107. The push-pull GPIOs are able to source or sink current from an external pin.

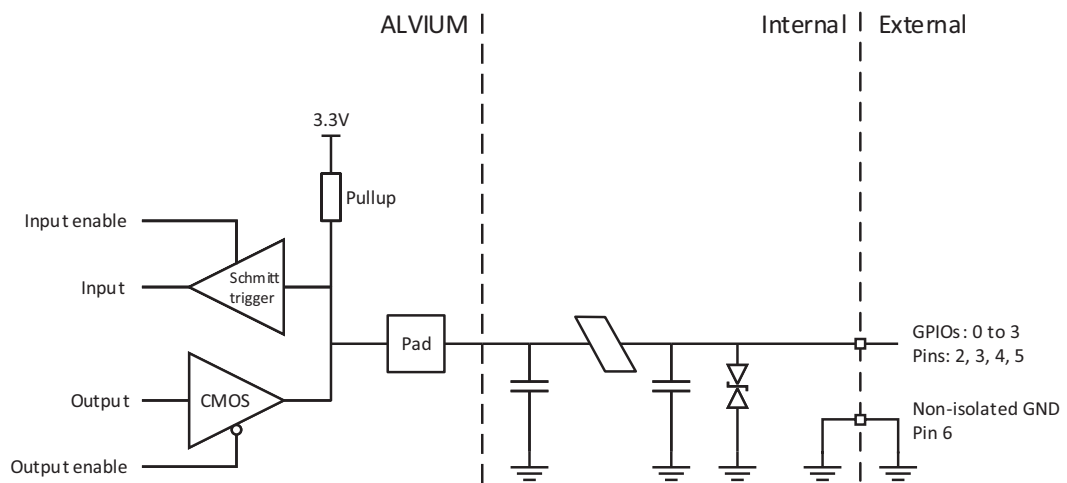

Figure 107: GPIOs block diagram

## Input levels

The GPIOs can be connected directly to the system controlling the camera for voltages up to 5.5 VDC. An external resistor is not necessary.



### NOTICE

#### Damage to the camera by high input voltage

Exceeding maximum input voltage can damage the camera.  
Keep maximum input voltage below 5.5 VDC.

Parameter	Value
$U_{in}$ (low)	-0.3 to 0.8 VDC
$U_{in}$ (high)	2.0 to 5.5 VDC
Undefined levels	0.8 to 2.0 VDC

Table 147: GPIOs as input, voltage levels

## Output levels



### NOTICE

#### Damage to the camera by high output current or voltage

The camera can be damaged when connected to a device that exceeds the specified maximum current or voltage. Consider maximum values:

- Maximum current = 12 mA per output
- Maximum Out VCC = 3.3 VDC

Parameter	Value
External output voltage $U_{out}$ (low)	0 to 0.4 VDC
External output voltage $U_{out}$ (high)	2.4 to 3.3 VDC
Undefined levels	0.4 to 2.4 VDC
Maximum external output voltage	3.3 VDC
Maximum output current	12 mA

Table 148: GPIOs as output, current and voltage levels



#### Output voltage for $U_{out}$ (high) = On state

The voltage level in the On state depends on the load current. Higher currents yield lower voltage.

## Status LED

Alvium USB cameras have a green status LED. The following table describes the flashing pattern indicating different events. Inverse flashing: If the LED is already on, it is switched off for a short time.



### LED settings

You can define LED settings with the `DeviceIndicatorLuminance` feature:

- A value of `10` enables LED signaling at the highest luminance level.
- Values below `10` reduce the luminance level.
- `0` disables LED signaling.

### Normal operation



LED codes	Behavior	Status
	Continuously active	Power on or idle state
	Irregular flashing	Command or image traffic, such as for camera startup
	Four short flashes and code sequence	Error state

Table 149: LED codes for normal operation

### Error conditions

Four short flashes followed by another sequence indicate errors. In this case, try the following to get the camera back to normal operation:

1. Restart the camera.
2. If the LED indicates error state again, please contact support at [www.alliedvision.com/en/about-us/contact-us/technical-support-repair/-rma](http://www.alliedvision.com/en/about-us/contact-us/technical-support-repair/-rma).

# Triggering and timings



This chapter includes:

Trigger signal flow .....	288
Trigger latency .....	288
Trigger features and UserSetDefault .....	289
Triggering with rolling shutter cameras .....	289
Trigger delay with 1800 U-120 cameras .....	289

## Trigger signal flow

Figure 108 shows an ideal diagram for the trigger signal flow. The external signal can be a physical source, such as light barrier as hardware trigger or a software trigger. This external signal starts the exposure of a frame. The end of exposure starts the readout. High levels show the active state of a signal.



### Features availability

States shown in the following graphic apply to Alvium USB cameras. Not all of the corresponding features may be supported. See the Alvium Cameras Features Reference at [www.alliedvision.com/en/support/technical-documentation/alvium-usb-documentation](http://www.alliedvision.com/en/support/technical-documentation/alvium-usb-documentation) for details.

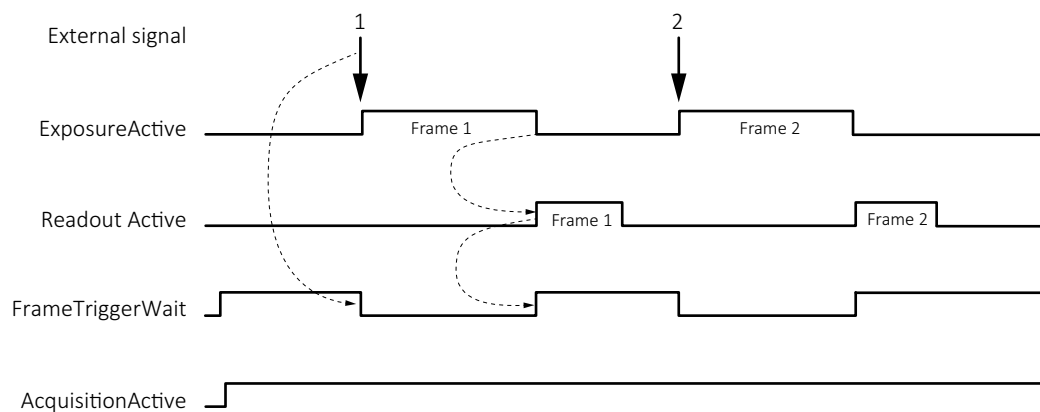

Figure 108: Schematic trigger signal flow

Term	Description
External signal	Electrical trigger signal starting the signal flow
Exposure Active	Exposing a frame
Readout Active	Reading out a frame (logical state, not a user feature)
Frame Start Trigger Wait	Waiting for a trigger
Acquisition Active	Enables frame acquisition: Expose, read out data, or wait for triggers.

Table 150: Trigger signal flow terms

## Trigger latency

In theory, a trigger creates an immediate response of the camera, depending on the cable length. In practice, the computer may add a delay that is mostly unpredictable, especially on Windows systems. In addition, camera electronics and sensors have a delay.

Rolling shutter (RS) cameras in this document also have exposure delay, depending on camera settings, see [Triggering with rolling shutter cameras](#) on page 289.



# Trigger features and UserSetDefault

See [Trigger features and UserSetDefault](#) on page 235.

## Trigger delay with 1800 U-120 cameras

If sensor related parameters are changed **directly before** sending an external trigger, the trigger delay can be increased. This relates to [Frame rate jitter](#) on page 300.

## Triggering with rolling shutter cameras

This section describes triggering behavior for **1800 U-500m/c, U-501m NIR, U-1240m/c, and U-2050m/c**. [Figure 109](#) shows how an external signal triggers exposure and readout for cameras with rolling shutter (RS) sensors. Like for global shutter (GS) sensors, readout has a constant duration, acquisition must be active to enable exposure, the end of exposure starts readout.

Rolling shutter (RS) sensors run in cycles where [readout area](#) equals [exposure area](#). Overlapping triggering is not supported. If exposure time is shorter than readout time, exposure starts with a delay:

$$\text{Exposure start delay} = \text{exposure area} - \text{exposure time.}$$

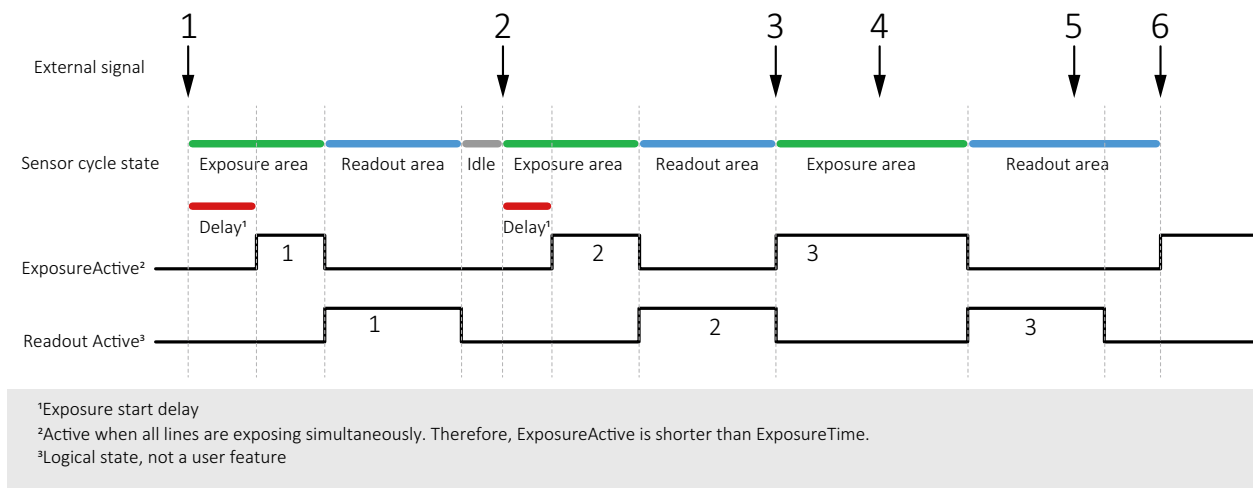

Figure 109: Triggering rolling shutter (RS) cameras

No	Conditions	Results
1	Exposure time is shorter than readout time.	Trigger 1 starts exposure 1 with a delay
2	Exposure time is shorter than readout time, but <b>longer</b> than for exposure 1.	Trigger 2 starts exposure 2 with a delay <b>shorter</b> than for exposure 1.
3	Exposure time is longer than readout time	Trigger 3 starts exposure time without a delay. Because the <b>exposure area</b> is longer, also the <b>readout area</b> is longer than for triggers 1 and 2
4	<b>Exposure area</b> is ongoing.	Trigger 4 is ignored.
5	<b>Readout area</b> is ongoing	Trigger 5 is ignored.
6	<b>Readout area</b> is finished. Exposure time is longer than readout time.	Trigger 6 starts exposure 6 without a delay

Table 151: Triggering conditions and results



#### TriggerSelector values for rolling shutter (RS) cameras

Cameras with rolling shutter (RS) **can** be triggered using *AcquisitionStart*, *AcquisitionEnd*, or *FrameStart* for TriggerSelector.

Cameras with rolling shutter (RS) **cannot** be triggered using *ExposureStart* or *ExposureEnd* for TriggerSelector.



#### Frame rates in triggered mode

When rolling shutter cameras are operated in triggered mode, the values for maximum frame rate reached in free run mode are cut in half.

## Ignored triggers

Alvium 1800 U-500m/c, U-501m NIR, U-1240 m/c, and U-2050m/c

Changing parameters while acquisition is active leads to ignored triggers until the parameters get active.

# Image data flow



This chapter includes:

Image data flow diagram .....	292
FPNC support .....	293

# Image data flow diagram

Figure 110 shows image data processing for Alvium USB cameras in general.

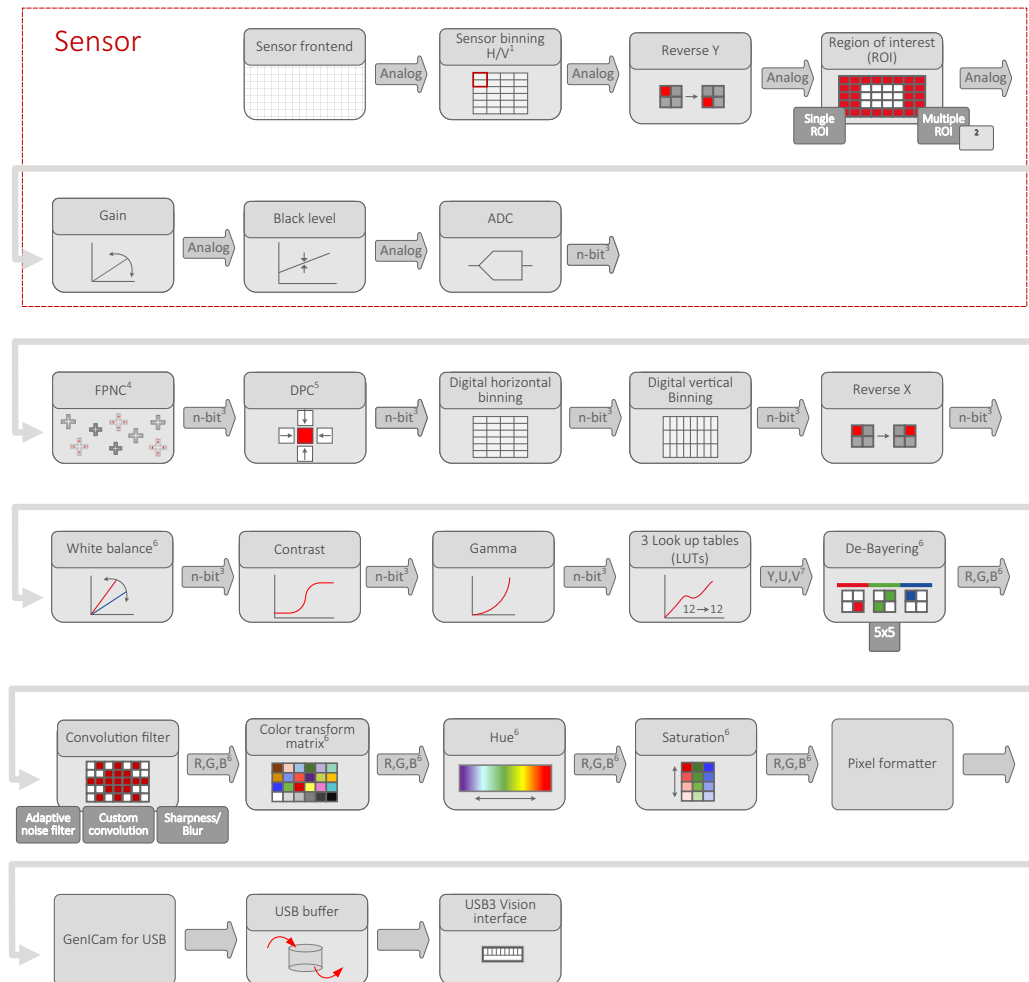

<sup>1</sup> Selected models only: See tables in the Specifications chapter.

<sup>2</sup> Model dependent: See tables in the Specifications chapter.

<sup>3</sup> Model dependent: See ADC bit depths in the Specifications chapter.

<sup>4</sup> Factory preset for FPNC = Fixed Pattern Noise Correction. See [FPNC support](#) on page 293 for supported models.

<sup>5</sup> Factory preset for DPC = Defect pixel correction. DPC is **currently not supported** by Alvium 1800 U-052, -291.

<sup>6</sup> Color models only

Figure 110: Image data flow of Alvium USB cameras



### Feature descriptions

The shown functionalities represent features or groups of features that are described in the Alvium Features Reference. See [www.alliedvision.com/en/support/technical-documentation/alvium-usb-documentation](http://www.alliedvision.com/en/support/technical-documentation/alvium-usb-documentation) for details.

## FPNC support

Table 152 shows which Alvium 1800 U models support FPNC (Pixed pattern noise correction):

Alvium model	Sensor	FPNC support	Alvium model	Sensor	FPNC support
1800 U-030 VSWIR	IMX991	-	1800 U-507	IMX264	✓
1800 U-040	IMX287	✓	1800 U-507 Pol	IMX264	-
1800 U-050	P480	✓	1800 U-508	IMX250	✓
1800 U-052	IMX426	-	1800 U-508 Pol	IMX250	-
1800 U-120	AR0135	✓	1800 U-510	IMX548	✓
1800 U-130 VSWIR	IMX990	-	1800 U-511	IMX547	✓
1800 U-131	EV76C560	✓	1800 U-530 VSWIR	IMX992	-
1800 U-158	IMX273	✓	1800 U-811	IMX546	✓
1800 U-192	EV76C570	✓	1800 U-812 UV	IMX487	✓
1800 U-203	IMX422	-	1800 U-895	IMX267	-
1800 U-234	IMX249	-	1800 U-1236	IMX304	✓
1800 U-235	IMX174	-	1800 U-1240	IMX226	✓
1800 U-240	IMX392	✓	1800 U-1242	IMX545	✓
1800 U-291	IMX421	-	1800 U-1620	IMX542	✓
1800 U-319	IMX265	✓	1800 U-2040	IMX541	✓
1800 U-320 VSWIR	IMX993	-	1800 U-2050	IMX183	-
1800 U-500	AR0521	✓	1800 U-2460	IMX540	✓
1800 U-501 NIR	AR0522	✓			

Table 152: FPNC availability by camera model

# Firmware update



This chapter describes how firmware is updated on Alvium USB cameras.

## Please note

You should update firmware only to change camera functions or fix known issues.

**Consider:** Any firmware update may not only add new features to a camera or fix known issues. It may also replace previous features or change camera characteristics. See firmware release notes for details.



### Keep the camera connected

- Keep the camera and computer running during firmware updates.
- If the camera is powered down during firmware update, the camera firmware may get into a non-functional state.



### Use only suitable firmware

If unsuitable firmware is used, the camera may get into a non-functional state.

- Only update to newer versions. Do not downgrade firmware to an older version, unless this has been explicitly communicated.
- We recommend updating the firmware to the next increment version only. Skipping versions may cause issues.

## Firmware update with Vimba X

1. Download and install **Vimba X**.  
The download includes Vimba X documentation.
2. Download the firmware (AVF file).



### Downloads

- For **Vimba X**, see [www.alliedvision.com/en/products/software/vimba-x-sdk](http://www.alliedvision.com/en/products/software/vimba-x-sdk).
- For firmware updates, see [www.alliedvision.com/en/support/firmware](http://www.alliedvision.com/en/support/firmware).

3. Connect your Alvim camera to the host.
4. Execute the installer of the firmware updater.  
The **Vimba X Firmware Updater** window opens, displaying your camera and the installed firmware version.
5. Continue with [Updating the firmware](#) on page 296.

## Updating the firmware



### Screenshots

The following instruction shows the firmware update on a **Linux** system. On **Linux** systems with other skins and on **Windows**, the GUI will look different.

The screenshots show an Alvium CSI-2 camera, but it applies to all interfaces.

1. Click **Open** to select the firmware for the update.

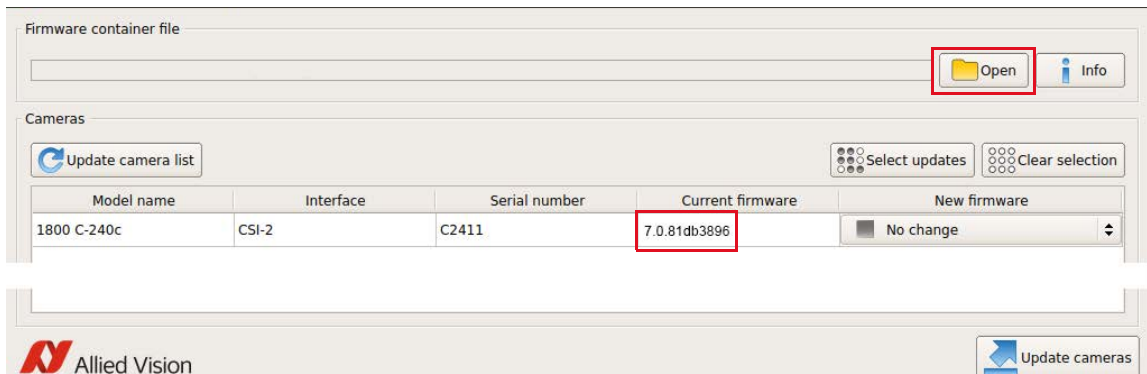

Figure 112: The camera and installed firmware are displayed

2. Select the firmware for the update from the drop-down menu.

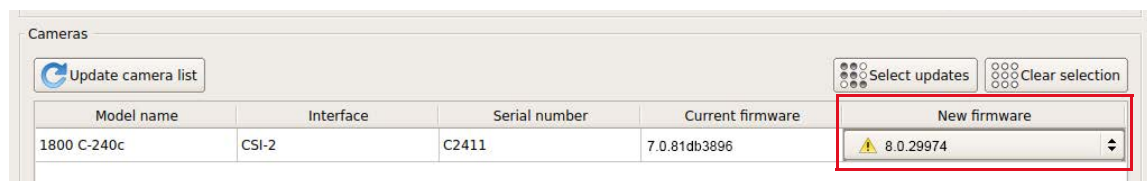

Figure 113: The firmware version is selected

3. Click **Update cameras**.

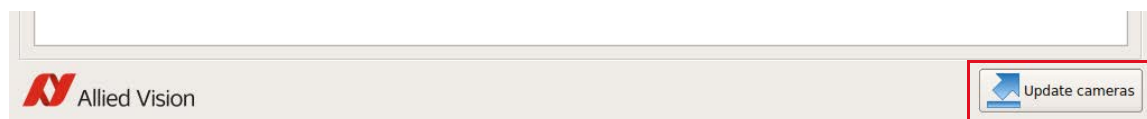

Figure 114: The update is being prepared



- Click **OK** to confirm.



Figure 115: The command to update the firmware is confirmed

The update progress is displayed.

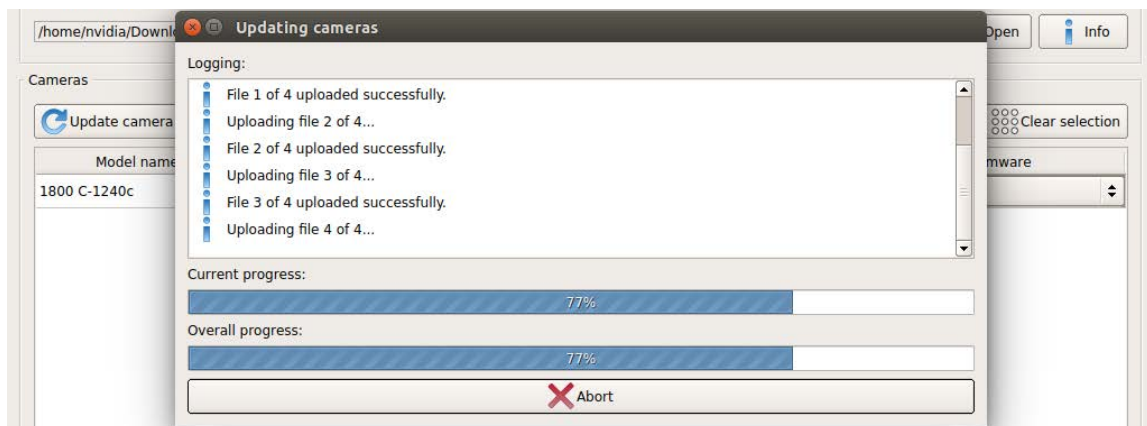

Figure 116: The update progress is displayed

- Click **Close** to confirm the completion of the update.

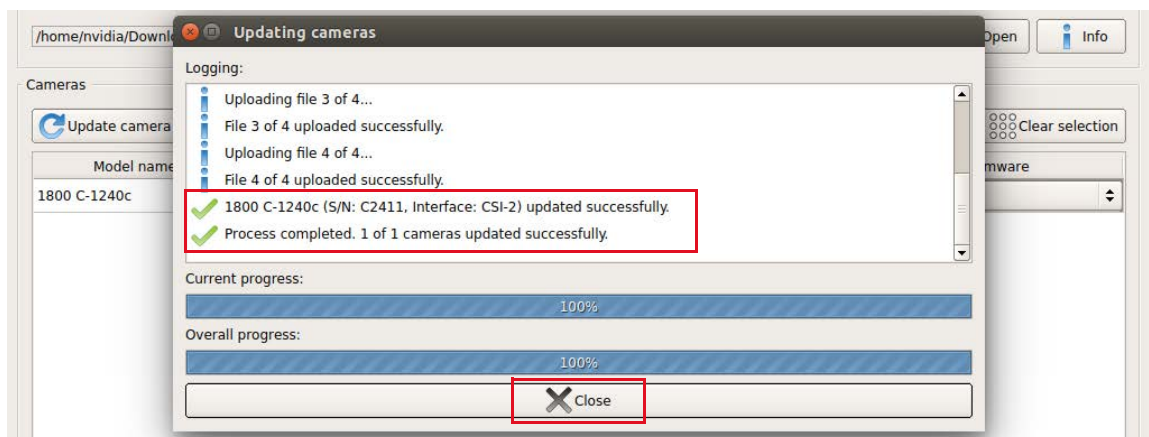

Figure 117: The update has been successfully completed

The camera is displayed with the updated firmware version.

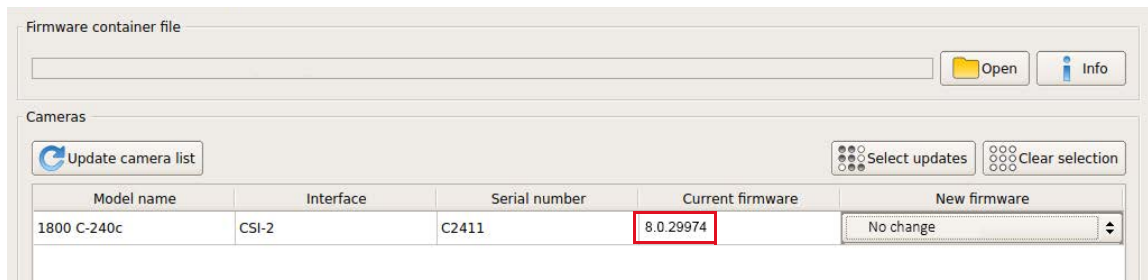

Figure 118: The updated firmware version is displayed

## Error handling

If firmware update fails,

- The camera is shown as “Fallback” on the USB bus.
- The camera is not recognized by **Vimba X Viewer**.
- You can repeat the firmware update.

Should the firmware update not succeed, please contact support at [www.alliedvision.com/en/about-us/contact-us/technical-support-repair-/-rma](http://www.alliedvision.com/en/about-us/contact-us/technical-support-repair-/-rma).

# Performance and troubleshooting



This chapter includes:

Optimizing performance.....	300
Troubleshooting common issues .....	313

# Optimizing performance

## Image transfer with rolling shutter cameras

Alvium 1800 U-500m/c, U-501m NIR, U-1240 m/c, and U-2050m/c

If acquisition is started and stopped in a short sequence, no image is transferred to the host. The duration cannot be predicted, because it depends on various factors.

## Parameter changes

If parameters are changed while these cameras are streaming, the following effects can occur.

### Stopped streaming

Alvium 1800 U-500m/c, U-501m NIR, U-1240 m/c, and U-2050m/c

When `AcquisitionMode` set to `MultiFrame`: If cameras are triggered by `AcquisitionStart`, the streaming stops when parameters are changed.

For `MultiFrame` acquisition, we recommend to you stop streaming before you change parameters.

### Frame rate jitter

Alvium 1800 U-120m/c, U-500m/c, U-501m NIR, U-1240 m/c, and U-2050m/c

Generally, some parameters can be changed during exposure without affecting the timing. For models with ON Semiconductor AR sensors and rolling shutter sensors, a different behavior must be considered for **camera operation in freerun mode without triggering**:

Changing parameters during exposure leads to frame rate jitter. When parameters are entered, the next frame starts only after readout and sensor reconfiguration delay are finished. When the camera is run in `ExposureAuto` mode, the actual frame rate is less than the calculated value for the corresponding exposure time. Consider frame rate jitter for your application, including a gap between `ExposureActive` signals.

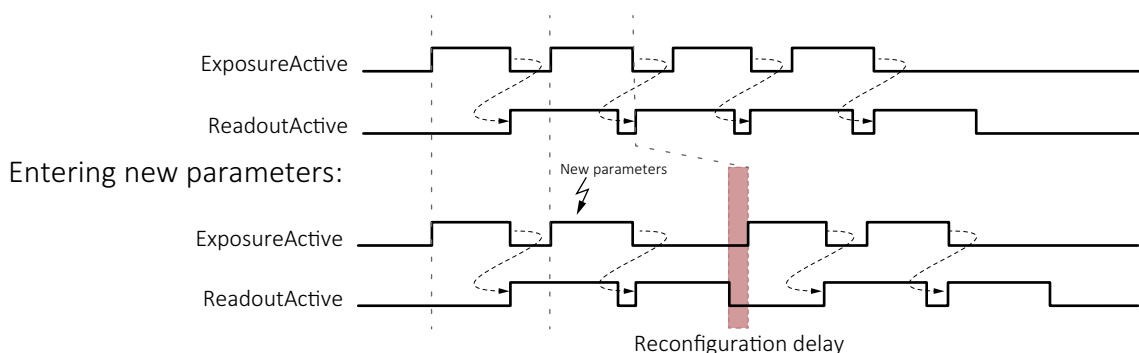

Figure 119: Delayed exposure due to parameter changes



### Parameter changes in triggered mode

See [Ignored triggers](#) on page 290 for more information.

## Value changes by feature interdependencies

The conversion between time and clock cycles affects control values. Features for pixel format, bandwidth, ROI, exposure time, and triggering are related to each other. Changing values for one feature can change values for another feature. For example, frame rates can be reduced when `PixelFormat` is changed subsequently. [Figure 120](#) shows the interdependencies.

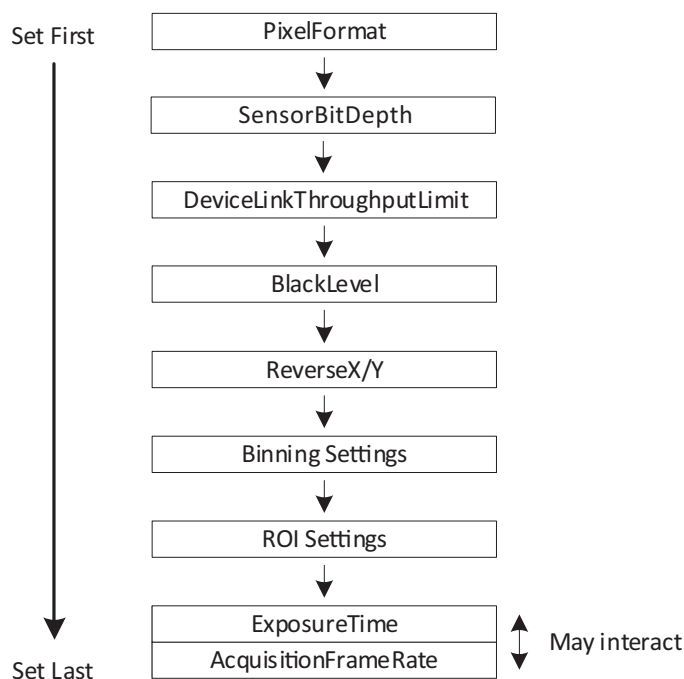

*Figure 120: Interdependencies between features*

## Effects for the interdependent features

Changing one control's value affects other control's values, such as:

If: `Height` value is changed.

Then: Other values may be affected, such as for `AcquisitionFrameRate` and `ExposureTime`.

We recommend you to consider:

- The more features you adjust, the more current values deviate from previously set values.
- The same effects that apply to `ExposureTime`, also apply to `AutoExposure`.
- To avoid readjustments, apply settings in the order shown in [Figure 120](#).

## Impact by other features

Input	Output	
	Exposure time values	Frame rate
AcquisitionFrameRate	Not affected	Affected
ExposureTime	Affected as expected	Affected
DeviceLinkThroughputLimit	Affected	Affected
Height	Not affected	Affected
Width	May be affected	May be affected

Table 153: Impact by other features

## Exposure times and frame rates with Sony IMX rolling shutter cameras

Alvium 1800 U-1240 m/c, and U-2050m/c

Generally, long exposure times result in low frame rates because one is roughly the inverse of the other. With Alvium IMX RS cameras

- The range of available frame rates depends on the exposure time.
- The exposure time must be increased when low frame rates are used.
- The available range for frame rate values depends on the exposure time. If by changing the exposure time, the previous frame rate is moved out of the available range, the frame rate is adjusted automatically.

## Dark current compensation

All sensors accumulate dark current in the pixels. Dark current increases the signal level and black level. Most sensors in Alvium USB cameras compensate for this.

For **Alvium 1800 U-050m/c** with the ON Semi PYTHON 480 sensor, see [Black level compensation for 1800 U-050m/c](#) on page 304.

If cameras are operated at high temperatures or long exposure times, compensation reaches its limits. The typical compensation mechanism uses a **margin** to compensate for dark current. This works only until dark current reaches the size of the margin. The following table shows the relation of the margin and accumulated dark current for a pixel in 8-bit mode with a maximum value of 255.

Effective signal versus noise	Description
	The pixel has accumulated no dark current, the margin has maximum size.
	The pixel has accumulated some dark current, reducing the size of the margin.
The following images show a pixel that has accumulated a higher dark current than the margin.	
	The pixel has accumulated dark current, the margin reduces to 0. <p><b>Type 1 compensation</b></p> <ul style="list-style-type: none"> <li>• Dark current compensation is stopped.</li> <li>• Dark current increases the black level.</li> <li>• Fixed pattern noise increases.</li> </ul>
	The pixel has accumulated dark current, the margin reduces to 0. <p><b>Type 2 compensation</b> (Typically used for sensor-internal compensation, often in the analog domain.)</p> <ul style="list-style-type: none"> <li>• Dark current compensation stays active.</li> <li>• Maximum saturation signal decreases.</li> <li>• Fixed pattern noise increases.</li> </ul>

Table 154: Accumulated dark current affecting the effective image signal

## Additional compensation

If compensation limits are reached and you cannot decrease operating temperature or exposure time, what can you do to keep signal quality high?

### Measures for type 1 compensation

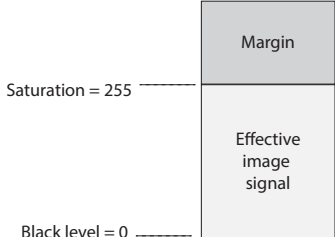
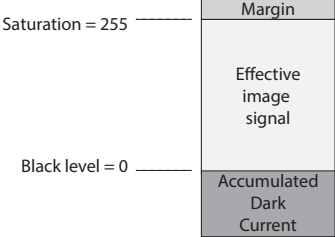
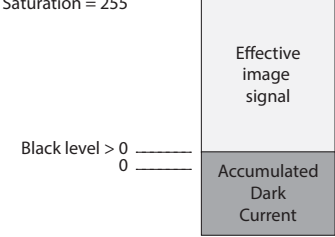
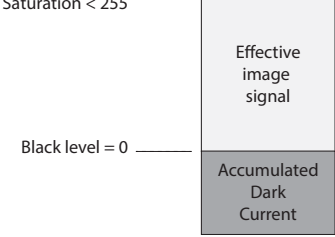
**Alvium 1800 U-050m/c** supports compensation type 1. For additional compensation, see [Black level compensation for 1800 U-050m/c](#) on page 304.

Typically, there is no measure to improve the image signal. The rising black level shifts black and dark gray values to gray.

### Measures for type 2 compensation

All other Alvium camera models support compensation type 2.

You can increase the margin size by using gain, with the following side effects:

- To give space to a larger margin, the effective pixel capacity decreases.
- White and light gray values are shifted down to gray.

### Black level compensation for 1800 U-050m/c

Because the ON Semi PYTHON 480 sensor does not have a dark current compensation, **Alvium 1800 U-050m/c** cameras have a typical black level value drift, depending on exposure time and **DeviceTemperature** (measured at the mainboard). [Table 155](#) shows the effect of the black level compensation. Should additional compensation be needed, we recommend cooling the camera.

Temperature [°C]	ExposureTime [ms]							
	1	10	50	100	250	500	750	1,000
35	Full	Full	Full	Full	Full	Full	Full	Full
40	Full	Full	Full	Full	Full	Full	Full	Full
45	Full	Full	Full	Full	Full	Full	Full	Full
50	Full	Full	Full	Full	Full	Full	Full	Full
55	Full	Full	Full	Full	Full	Full	Full	Full
60	Full	Full	Full	Full	Partial	Partial	Partial	Partial
65	Full	Full	Full	Partial	Partial	Partial	Partial	Partial
70	Full	Full	Partial	Partial	Partial	Partial	Partial	Partial
75	Full	Partial	Partial	Partial	Partial	Partial	Partial	Partial

	Full compensation
	Partial compensation

Table 155: Exposure time and temperature affecting black level compensation



## Shutter types affecting image readout

Most Alvim USB camera models are operated using global shutter (GS):

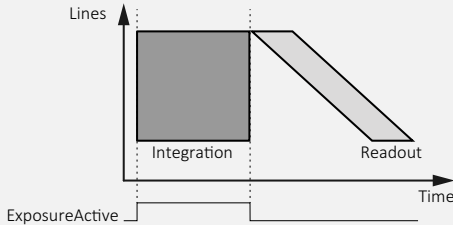
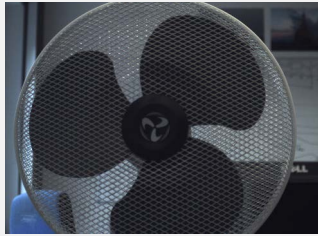
Property	Line readout	Moving image
Global shutter (GS)		

Alvim 1800 U-500 and 1800 U-501 NIR models use rolling shutter (RS). Alvim 1800 U-1240 and 1800 U-2050 models offer global reset shutter (GRS) in addition:



Property	Rolling shutter (RS)	Global reset shutter (GRS)
Line readout		
Line exposure start	Deferred from line to line	Common for all lines
Line exposure time	Common for all lines	Increases from line to line
Image acquisition of moving objects		
Image brightness	Constant over the image	Varying over the image
Moving objects	Distorted shape	Shape without distortion
Typical application	Static objects	Moving objects
Compensation	Use an additional mechanical shutter or use a strobe light:	
		

Table 156: Shutter types affecting image readout

## Host setup and bandwidth

If the camera data output exceeds the bandwidth supported by the host computer, images may be corrupted. This section gives some background information to enable proper image transfer.

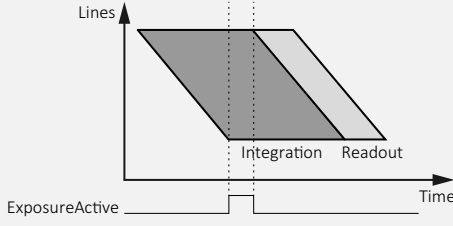
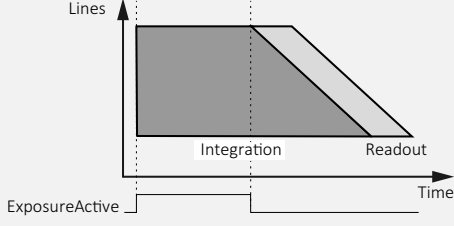
### Sensor data output and camera data output

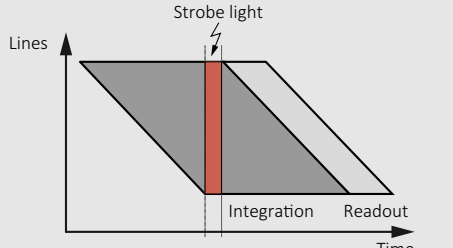
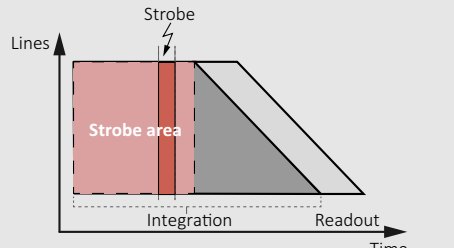
For cameras with an image buffer, the required bandwidth for image acquisition can be estimated for a given frame rate, pixel format, and resolution by over-the-thumb calculations. Alvium cameras do not have an image buffer.

Figure 121 shows the bandwidth for a higher (1) and a lower (2) value for `DeviceLinkThroughputLimit`.

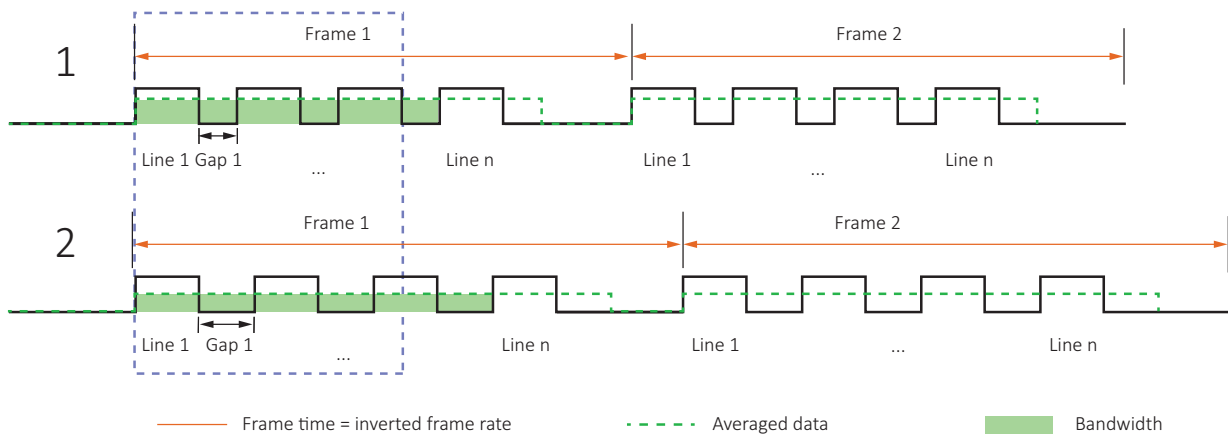

Figure 121: Sensor data output and camera data output

- Cameras **without** an image buffer like Alvium: Data is averaged over the line time.
- Cameras **with** an image buffer: Data rate is averaged over the frame time.
- Using `DeviceLinkThroughputLimit`: Reduce the maximum line data rate.

`DeviceLinkThroughputLimit` controls the maximum bandwidth of the data streamed out by the camera. When the value for this feature is reduced, the gaps between the lines are increased. This reduces the frame rate and therefore the bandwidth.

Additionally, you may reduce the frame rate to reduce bandwidth.

Consider that **Vimba X Viewer** does not gray out values that exceed the bandwidth supported by the host computer.



#### More information on `DeviceLinkThroughputLimit`

For more information on `DeviceLinkThroughputLimit`, see the Alvium Cameras Features Reference at [www.alliedvision.com/en/support/technical-documentation/alvium-usb-documentation](http://www.alliedvision.com/en/support/technical-documentation/alvium-usb-documentation).

## Vimba X settings

During freerun, Alvium cameras do not automatically adapt the frame rate to the USB controller's limits. If the data rate is too high for your USB controller, it receives corrupted frames. The image transfer status in **Vimba X Viewer** is signaled as **Running**. However, the corrupted frames are not displayed.

## Requirements for USB PCIe cards and host controllers

Ensure sufficient bandwidth is supported by the USB host adapter cards **and** by the corresponding USB PCIe host controllers on your host system. 450 MByte/s are required to reach maximum frame rates for some Alvium USB camera models. Adding the typical overhead for USB communication, even 500 MByte/s can be insufficient. We recommend using roughly **1 GByte/s per camera**.

In [Table 157](#) you can see that, for example, Version 1.1 PCIe host controllers with 1 lane do not support the bandwidth required to operate a single camera at full performance.

Lanes ↓	Throughput		
PCIe version →	1.0 / 1.1	2.0 / 2.1	3.0 / 3.1
× 1	250 MByte/s	500 MByte/s	0.99 GByte/s
× 2	500 MByte/s	1 GByte/s	1.97 GByte/s
× 4	1 GByte/s	2 GByte/s	3.9 GByte/s

*Table 157: Requirements for USB PCIe host adapters*

### Potential limitations with 4-port cards

Observe that some 4-port PCIe cards have limitations: They use shared resources and do not support the required bandwidth when each port is used.



#### Suitable USB 3.0 accessories

See [www.alliedvision.com/en/products/accessories](http://www.alliedvision.com/en/products/accessories) for suitable USB 3.0 or 3.1 Gen 1 host controller cards and cables or contact your Allied Vision Sales representative.

## Shared bandwidth on a common USB bus

### Ideal setup for two cameras

#### Preconditions

- Control traffic is ignored.
- The possibility of the host being busy with other tasks is ignored.
- Cameras share 100 percent bus bandwidth.
- Cameras need 100 percent bus bandwidth in total.
- Cameras stream in the same way because they are the same model and have identical settings.
- No other device is connected.

#### Result

- Bandwidth is divided by two, cameras get assigned 50 percent bandwidth each.  
For three cameras, the bandwidth is 33.3 percent each.
- If one camera sends no data, the other camera will be assigned 100 percent bandwidth. To always assign 50 percent to both cameras, they have to be controlled to use no more than 50 percent bandwidth each.
- If the computer cannot process the images received from a camera, images are corrupted.

### Best practice for bandwidth management

- To assign maximum bandwidth to a camera, make sure your camera is the only device on the bus.
- Avoid devices, such as a monitor or a mouse, sharing bandwidth with the USB camera connected to the same bus.
- For maximum bandwidth, use a current version host controller card.  
See [www.alliedvision.com/en/products/accessories](http://www.alliedvision.com/en/products/accessories).
- USB3 Vision devices use bulk transfer. Avoid using other transfer modes.
- Control bandwidth by assigning the desired amount to the separate cameras.

### Cascading hubs divide bandwidth

The following example applies to standard behavior without individual settings. The graphics show bandwidth distribution on a common bus. Three cameras try to use full bandwidth at the same time. If one camera is inactive, the host will provide its share to the others until this camera sends data again. See [Figure 122](#) on page 308.

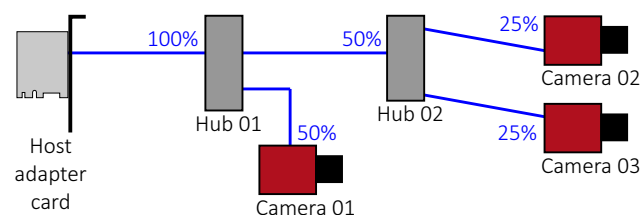

Figure 122: Bandwidth assignment for cascading hubs

## Using the U3 mode

If you want to pause camera operation, you can use the U3 mode to reduce the power consumption of Alvium USB cameras. For example, with *SuspendMode*, the remaining power consumption is ~ 16 mA.

In this section, you learn to change between operational mode and U3 mode by *DevicePowerSavingMode* and host or backend commands.

The *DevicePowerSavingMode* feature selects between standard power use and various power saving modes, avoiding unexpected camera behavior:

Values	Description
<i>Disabled</i>	The camera uses standard power (default).
<i>StandbyMode</i>	Camera functions are disabled to reduce power consumption. However, the control channel is maintained active: the camera can still be controlled by GenICam features.
<i>SuspendMode</i> <b>Recommended with Linux.</b>	The camera is enabled to go into USB U3 power saving mode. The Phy shuts the camera down. The host must send a <i>DevicePowerSave</i> command or a respective backend command to the camera to apply <i>SuspendMode</i> . The camera reboots itself. After reboot, all camera settings are reset to default values, <i>DevicePowerSavingMode</i> is reset to <i>Default</i> .

Table 158: Options for *DevicePowerSavingMode*



### Please observe

The U3 mode is not supported for USB 2.x connections.



### Using power saving modes

#### StandbyMode

Use *DeviceReset* command to switch from *StandbyMode* back to *Disabled* for standard power mode.

#### SuspendMode

- [Using SuspendMode under Linux](#) on page 310
- [Using SuspendMode under Windows](#) on page 311

## Using SuspendMode under Linux

### Activating U3 mode

1. Connect to the camera and use as you like.
2. Set `DevicePowerSavingMode` to `SuspendMode`.
3. Close all **Vimba X** connections, including the first **Vimba X Viewer** dialog.

Linux requires to change the following settings to bring a USB device to U3 mode:

- `power/control => auto`
- `power/autosuspend_delay_ms => 0`

The following script to put the camera to U3 mode can be used on most hosts.

4. Execute this script with root privileges. For example, save this script as **U3.sh** and use the command `sudo ./U3.sh`:

```
#!/usr/bin/env bash

# https://www.kernel.org/doc/html/v4.13/driver-api/usb/power-
# management.html#the-user-interface-for-dynamic-pm
find -L /sys/bus/usb/devices/ -maxdepth 2 -regextype posix-
extended -regex '/sys/bus/usb/devices/[0-9]+\-[0-9]+' | while
read port; do
    if [[ $(< $port/idVendor) == "1ab2" ]]; then
        if [[ $1 == on ]]; then
            echo "Activating port: $port"
            echo on > $port/power/control
            echo 2000 > $port/power/autosuspend_delay_ms
        else
            echo "Suspending port: $port"
            echo auto > $port/power/control
            echo 0 > $port/power/autosuspend_delay_ms
        fi
    fi
done
```

*Code Listing 1: Linux script to change to U3 mode*

### Reactivating operational mode

Open **Vimba X Viewer**.

The camera boots up. This may take about 2 seconds.

## Using SuspendMode under Windows

### Activating U3 mode

1. Connect to the camera and use as you like.
2. Set the `DevicePowerSavingMode` to `SuspendMode`.
3. Close all **Vimba X** connections, including the first **Vimba X Viewer** dialog.
4. In the **Device Manager**, click **Disable Device** for the Allied Vision USB3 Vision Device:

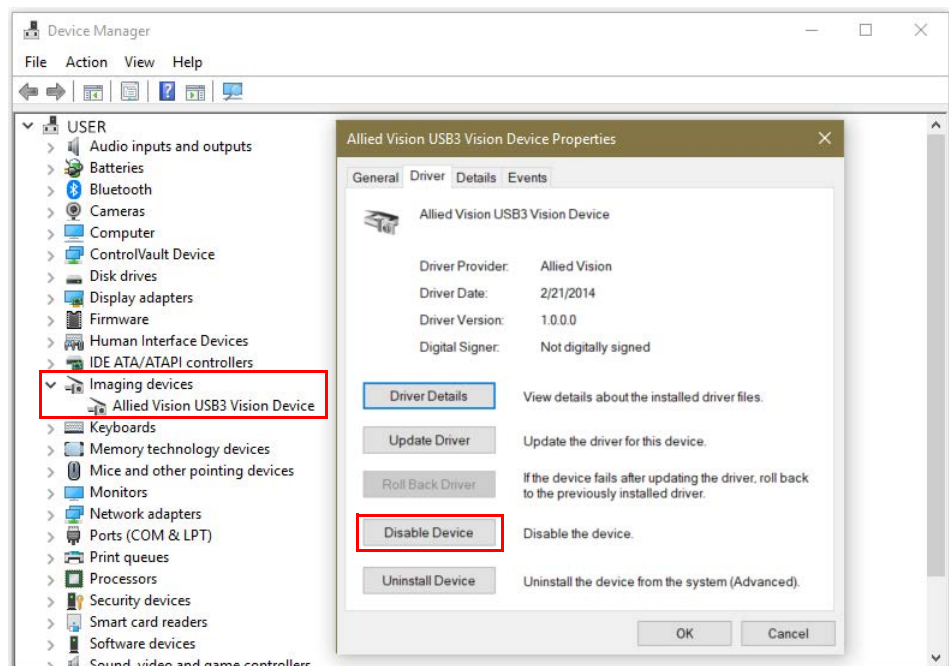

Figure 123: Disabling the Alvim camera in the Device Manager

## Reactivating operational mode

1. In the **Device Manager**, click **Enable Device** for the Allied Vision USB3 Vision Device:

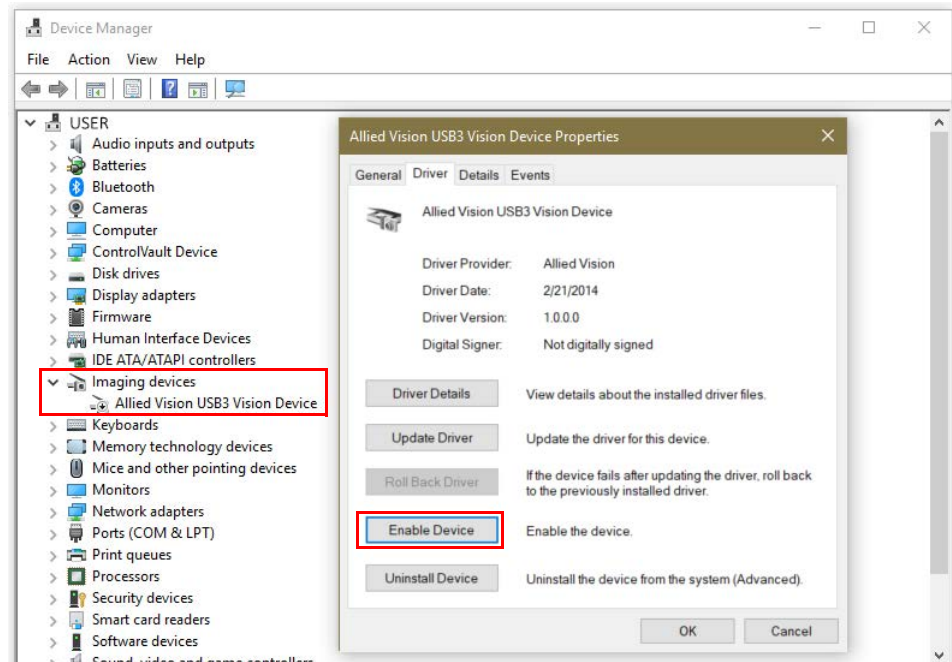

Figure 124: Enabling the Alvium camera in the Device Manager

2. Open **Vimba X Viewer**.

The camera boots up. This may take about 2 seconds.

## Power consumption issues

The power consumption of cameras is caused by such as the image sensor and enabled features. The total power for the host system also includes the USB cable loss. Unfavorable setups can prevent your system from working. What can you do?

### Ensure sufficient power supply

Your host system must provide sufficient voltage and current at the USB downstream connector on the host system for proper camera operation. If this is not the case, we recommend you to power cameras by an external power supply, using the I/O connector (see [Camera interfaces](#) on page 275 for details).



## Reduce the power consumption

This applies **only if cameras are powered via USB**. When Alvium USB cameras begin to exceed the maximum current allowed by the USB 3.0 standard, cameras are automatically shut down.

Some features increase the power consumption:

- ConvolutionMode
- SensorBitDepth

Try not to use these features at the same time to reduce the power consumption.



### Support

If you are still facing issues, please contact support at [www.alliedvision.com/en/about-us/contact-us/technical-support-repair-/-rma](http://www.alliedvision.com/en/about-us/contact-us/technical-support-repair-/-rma).

# Troubleshooting common issues

In this section you can find questions and answers about problems with camera operation. The events are ordered from general to detail:

- [Camera recognition](#)
- [Unexpected events](#)
- [Performance](#)
- [Radio signal interference](#)

Each entry consists of:

- Observed unwanted event, numbered for easier handling
- Short description of the solution
- Step-by-step instructions to resolve the issue.



### Hardware installation

For background information, see [Installing the camera](#) on page 256.

## Camera recognition

### How can I make the computer and Vimba X Viewer recognize the camera?

1. Check if the **hardware** supports your USB camera.  
Is the power supply sufficient to operate the camera? See [Power consumption issues](#) on page 312.  
See [www.alliedvision.com/en/products/accessories](http://www.alliedvision.com/en/products/accessories).

#### Windows only

2. Check if your computer has an appropriate **USB 3.0 or 3.1 Gen 1 host controller driver** installed.  
**Windows 8 and later OS** provide a USB 3.0 or 3.1 Gen 1 host controller driver. On a properly installed OS, no problems should occur.  
**Windows 7 and earlier OS** do not provide a USB 3.0 or 3.1 Gen 1 host controller driver.  
To install the host controller card:  
Download the manufacturer USB 3.0 or 3.1 Gen 1 host controller driver.  
Install the driver on your computer.  
Result: The installed driver enables the host controller.

#### Windows only

3. Check if the **USB3 Vision device driver** is properly installed and assigned to the camera.  
Follow the instructions in [Installing the host adapter and Vimba X](#) on page 270.
4. The camera, **connected to a USB 3.0 or 3.1 Gen 1 hub**, is not recognized anymore. Check if the USB 3.0 or 3.1 Gen 1 hub has crashed.
  1. Disconnect the USB and power supply cable from the hub.
  2. Reconnect both.Result: The camera is recognized again.
5. The camera, **connected directly to the computer**, is not recognized anymore. Check if a hub included in the **USB host controller** has crashed.
  1. In the **Device Manager**, deactivate the host controller.  
For **Windows**, see [Installing the camera driver with Windows tools](#) on page 273.
  2. Reactivate the host controller.Result: The camera is recognized again.

## Unexpected events

### How do I get the camera back to normal operation?

1. Check if the **camera is active**.
  - If: The camera is shut down after changing feature settings.
  - Then: Restart the camera with previous feature settings used before the changes. Read how to [Reduce the power consumption](#) on page 313.
  
2. Check if an error is shown by the **camera Status LED**.
  - If: The status LED signals four short flashes followed by another sequence.
  - Then: Restart the camera.
  - If: If the status LED again signals four flashes.
  - Then: Please contact support at [www.alliedvision.com/en/about-us/contact-us/technical-support-repair/-rma](http://www.alliedvision.com/en/about-us/contact-us/technical-support-repair/-rma).
  
3. Check if **power cables**, such as cables with a high current in the environmental setup, **harmfully interfere with camera cables**.
  - If: Any camera cable crosses or goes parallel with a power cable.
  - Then: Separate camera cables from power cables.
  
4. Make sure the **camera is intact**.  
For this, exclude issues of the cable or the connected computer:
  1. Connect the camera with a **different cable** to a **different computer**.
    - If: The camera works properly.
    - Then: The camera is intact, but your previous computer or cable has a defect. Continue with 2.
  - If: The camera does not work properly.
    - Then: Most likely, the camera has a defect. Please contact Allied Vision support.
  2. Connect the camera with the **previous cable** to the **different computer**.
    - If: The camera works properly.
    - Then: Replace the cable.
  3. Connect the camera with the **replaced cable** to the **previous computer**.
    - If: The camera does not work properly.
    - Then: Check the computer to fix the issue.

### Why does the camera not transfer images?

1. The value for `DeviceLinkThroughputLimit` is set higher than the bandwidth supported by the host system.  
Then: Check if sufficient bandwidth is assigned to the camera. See [Host setup and bandwidth](#) on page 306.
2. The camera is **connected to a USB 2.0 port** and requires a bandwidth higher than 50 MByte/s.  
Then: Connect the camera to a USB 3.1. Gen 1 port.

## Performance

### How can I improve camera performance?

1. Check if the **hardware** sufficiently supports your USB camera.  
See [www.alliedvision.com/en/products/accessories](http://www.alliedvision.com/en/products/accessories).
2. Check if the **USB host adapter card and the USB PCIe host controller** support the available bandwidth.  
See [Requirements for USB PCIe cards and host controllers](#) on page 307.
3. Check if the **camera shares the bus with other devices** reducing the available bandwidth.  
Connect the camera to an individual bus, not shared by other devices.  
For more information, see [Shared bandwidth on a common USB bus](#) on page 308.
4. Check if the **camera is connected to cascading hubs**, reducing the available bandwidth.  
Attach devices directly to a separate USB 3.0 or 3.1 Gen 1 bus. If you want cameras to share a common bus, use only a single hub to attach devices. For more information, see [Shared bandwidth on a common USB bus](#) on page 308.
5. Check if all your USB **accessories support USB 3.0 or 3.1 Gen 1**.  
For recommended USB accessories, see [www.alliedvision.com/en/products/accessories](http://www.alliedvision.com/en/products/accessories).

## Radio signal interference

### How can I avoid radio signal interference from wireless devices?

Ensure camera installation complies with **Electromagnetic Compatibility**.

Wireless devices and USB 3.0 or 3.1 Gen 1 commonly use 2.4 GHz frequency (WLAN includes 2.4, 3.6, and 4.9 GHz).

Even USB 3.0 and 3.1 Gen 1 cables can interfere harmfully with other electromagnetic devices. For example, despite shielding, a USB 3.0 or 3.1 Gen 1 cable can interfere with a wireless mouse. Tests have shown an increase of the noise floor up to 20 dB for the affected devices.

- To enable maximum bandwidth, 2.4 GHz radio frequencies must be avoided; therefore, use **maximum shielded cables only**.
- Keep **maximum distance** between your Alvium USB camera setup and interfering devices.
- Use **high-gain antennas** to reduce power of the radio signals.

For tested USB accessories, see [www.alliedvision.com/en/products/accessories](http://www.alliedvision.com/en/products/accessories).

# Index

## A

Allied Vision contact .....	21
Alvium Flex	
dimensions and mass .....	222
interface connection .....	279
overview .....	17
technical drawings .....	222
Alvium Frame	
aligning .....	263
dimensions and mass .....	227
installing .....	263
mounting .....	264
overview .....	19
sensor position accuracy .....	233
technical drawings .....	227
Alvium Frame Flex	
dimensions and mass .....	228
technical drawings .....	229

## B

bandwidth	
cascading hubs .....	308
division on a common bus .....	308
troubleshooting .....	306
bare board cameras .....	257
BIOS drivers .....	62

## C

camera identification	
Model ID .....	50
serial numbers .....	258
camera installation	
drivers for camera and host adapter .....	270
Windows .....	270
CE .....	50
China RoHs .....	50
compliance .....	50
connectors .....	275
conventions in this document .....	45
current and voltage .....	57

## D

digital binning .....	71
dimensions and mass	

Alvium Flex .....	222
Alvium Frame .....	227
Alvium Frame Flex .....	228
standard Alvium .....	205
document	
conventions .....	45
history .....	32
overview .....	15
terms .....	46
driver installation .....	269

## E

ESD .....	56
ExposureMode and exposure times .....	69

## F

features	
availability .....	236
interdependencies .....	301
firmware update .....	295
flange focal distance .....	205
FPC connectors, pin assignment .....	279
frame rate	
reference settings .....	69
rolling shutter sensors .....	70
Sony IMX rolling shutter .....	302

## G

GenICam .....	64
global reset shutter (GRS) .....	305
global shutter (GS) .....	305
GPIOs	
input levels .....	285
output levels .....	285
ground .....	279
ground loops .....	57

## H

hardware assembly	
aligning Alvium Frame .....	263
camera mounting - Alvium Frame .....	264
camera mounting - bare board .....	260
camera mounting - housed cameras .....	262
heat sink mounting .....	259
lens mounting .....	265
heat dissipation .....	54
Hirose DF40C-50DP-0.4V	
description .....	279

safety .....	58	BIOS drivers .....	62
host controller requirements .....	307	camera power .....	57
hubs .....	308	electrical connections .....	56
<b>I</b>		GPIOs .....	57
image data flow .....	292	ground loops .....	57
intended use .....	53	heat dissipation .....	54
interfaces .....	275	heat sinks .....	61
IR cut filter .....	231	Hirose DF40C-50DP-0.4V .....	58
<b>K</b>		lens mounts .....	53
KC .....	50	maximum protrusion .....	61
<b>L</b>		optical components .....	59
lanes .....	279	PCBAs .....	56
LED .....	286	sensor .....	60
lenses .....	239	USB cables .....	58
focal length vs. field of view .....	241	USB host controllers and hubs .....	58
maximum protrusion .....	61	sensor ADC readout modes .....	68
mounting .....	265	sensor binning .....	71
vignetting .....	240	sensor cleanliness (definition) .....	60
<b>M</b>		sensor handling .....	60
maximum protrusion		sensor position accuracy .....	232
safety .....	230	shift and rotation with Alvium Frame ....	233
MutipleRegions .....	72	standard and Alvium Flex .....	232
<b>N</b>		shock and vibration .....	64
naming .....	46	S-Mount lenses .....	241
<b>P</b>		mounting .....	266
performance .....	300	software installation .....	269
pin assignment .....	279	specifications .....	63
power consumption		standard Alvium	
reference settings .....	74	dimensions and mass .....	205
<b>Q</b>		technical drawings .....	207
quantum efficiency .....	66	streaming is stopped .....	300
<b>R</b>		support .....	21
radio signal interference .....	317	<b>T</b>	
readout modes .....	68	technical drawings	
rolling shutter (RS) .....	305	Alvium Flex .....	222
<b>S</b>		Alvium Frame .....	227
safety .....	2, 8, 53	Alvium Frame Flex .....	229
bare board cameras .....	59	standard Alvium .....	207
		term definitions .....	46
		triggering .....	287
		troubleshooting .....	299
		camera recognition .....	314
		frame rate jitter .....	300
		parameter changes .....	300
		performance .....	316
		radio signal interference .....	317
		streaming is stopped .....	300

unexpected events .....	315	host controller requirements .....	307
troubleshooting		USB 2.0 .....	59
bandwidth .....	306, 308	USB cables .....	58
black level compensation .....	304	USB host controllers and hubs .....	58
dark current compensation .....	302	USB3 Vision .....	64
shutter types and image readout .....	305	user sets .....	235
U		W	
UART .....	283	WEEE .....	50
UKCA .....	50	white balance default .....	204
USB			